

EN

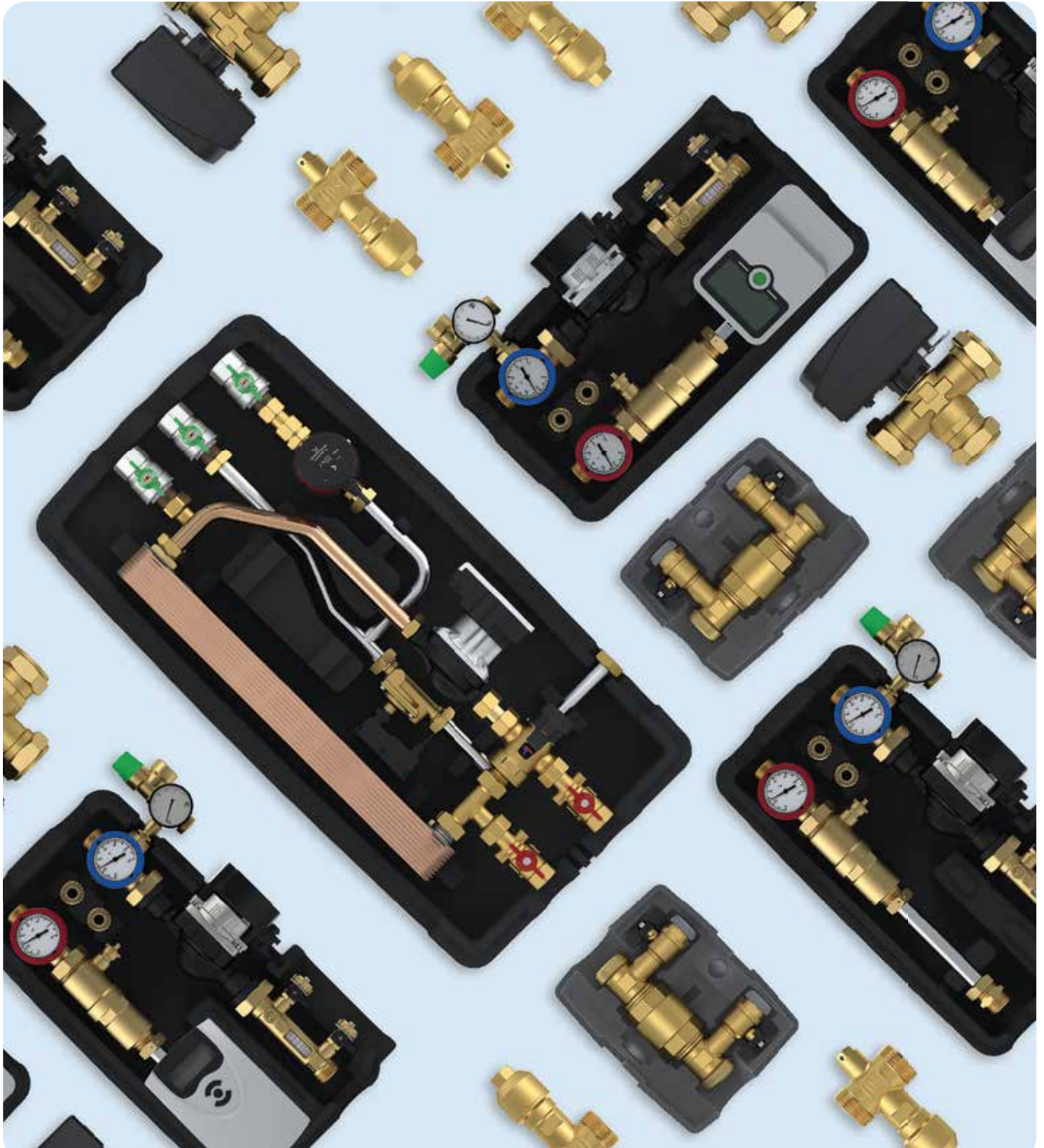

LK Armatur

Product Catalogue 2024



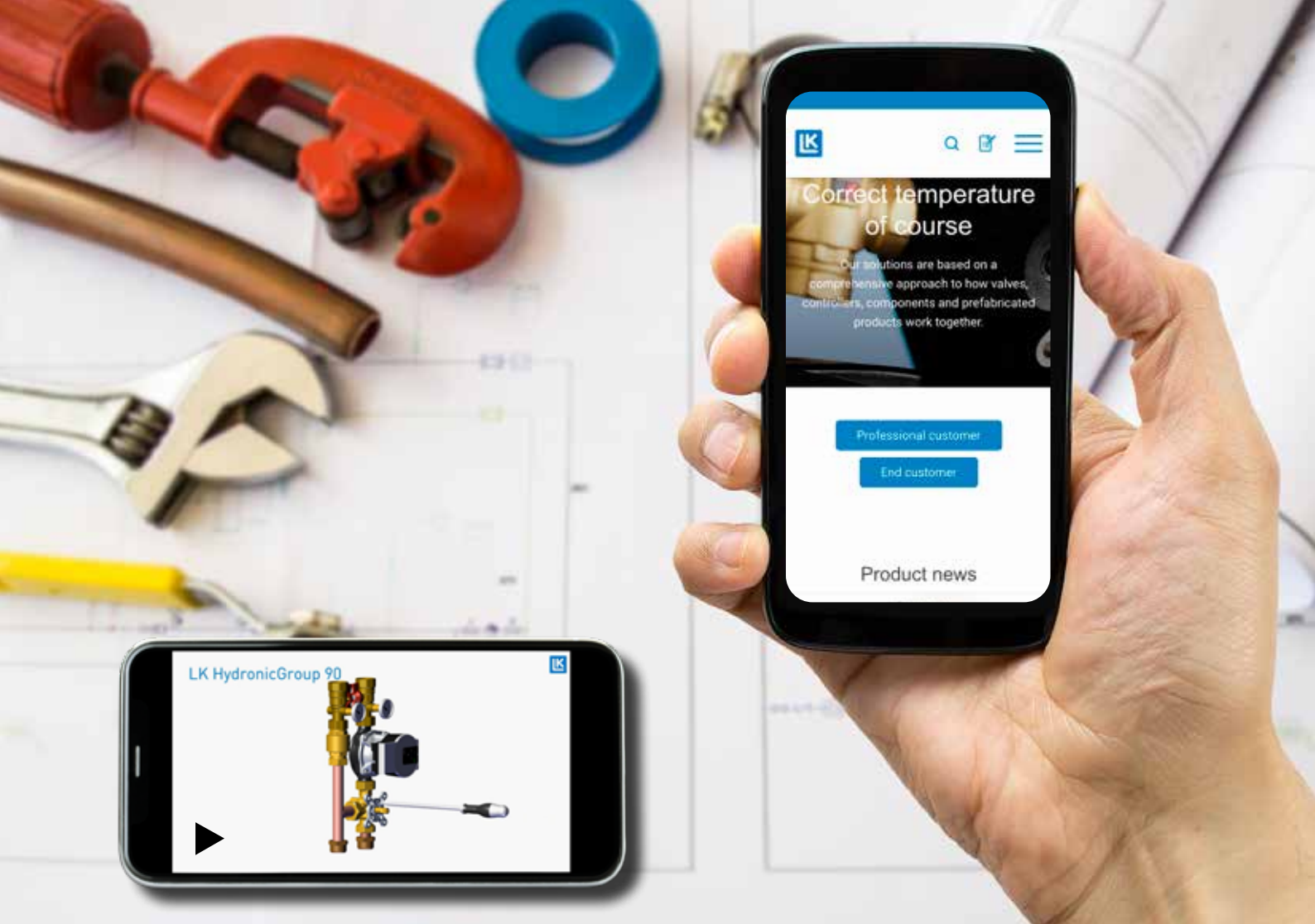

Did you know?

You always have the catalog with you

On our mobile-adapted website, you will find everything in the catalog and more. There you have our entire range of information at product level, assembly instructions, contact information, etc.

You can also choose to print your own product sheets over different assortments where you get with product descriptions, pictures, article numbers, dimensions and sketches.



Movies and the latest news!

Follow us on social media



mynewsdesk



www.lkarmatur.com

New Products 2024

Safety Valve



LK 556 AntiFreeze

- Protects heating system from freeze damage
- The valve is maintenance-free
- Can be insulated to save energy

p. 181

Electric Portable Boiler



LK 450 EasyHeat P

- Programmable
- Portable
- Water level detection
- Lockable cabinet

p. 166



LK 450 EasyHeat M

- Manual
- Portable
- Water level detection
- Lockable cabinet

p. 168

Safety Group



LK 994 SafetyGroup

- Adjustable bracket
- Automatically closes against the heating system when removing expansion vessel

p. 185

Valve Combination



LK 250 TapWater Unit

- Easy to install
- Scald protection with LK 551 HydroMix
- Available with anti-limestone coated heat exchanger

p. 38

Valve Combination



LK 322 CoolUnit

- Insulation against condensation
- Energy effective way for free cooling
- Recharge the borehole during the summer

p. 133

Cyclone Filter



LK 360 NetMag

- Extend the service life of your heating system
- Energy-saving
- Rotatable filter housing, can be installed vertically and horizontally

p. 173

Loading Units



LK 811 ThermoMat 2.0 W

- Adjustable return temperature
- Electronic regulation ensures an easy operation

p. 14

Mixing Valves



LK 840 HG ThermoMix® 2.0 LK 850 HG ThermoMix® 2.0

- Easy to adapt for electronic controller
- Suitable for pump groups

p. 72

Solar Pump Units



LK 211 SolarStation

- Reduced energy costs by using solar power
- Compact single-pipe solar unit
- Connections with 3/4" female thread and 1" male thread

p. 42

LK 212 SolarStation

- Reduced energy costs by using solar power
- Compact dual-pipe solar unit
- Connections with 3/4" female thread and 1" male thread

p. 45



Loading Units

LK 810 ThermoMat 2.0.....	10
LK 811 ThermoMat 2.0 W.....	14
LK 815 ThermoKit T Eco.....	16
LK 816 ThermoKit E Eco.....	18



Pump Groups

LK HydronicGroup 90C.....	24
LK HydronicGroup C/C 90.....	25
LK HydronicGroup C/C 125.....	28



Tap Water Units

LK 250 TapWater Unit.....	38
---------------------------	----



Solar Stations

LK 211 SolarStation.....	42
LK 212 SolarStation.....	45



Thermic Valves and Check Valves

LK 820 ThermoVar@.....	50
LK 821 ThermoVar@.....	53
LK 822 ThermoBac.....	55
LK 823 ThermoVar@.....	57
LK 823 ThermoVar@ R.....	59



Mixing Valves

LK 525 MultiZone 3R.....	62
LK 830 ThermoMix@ B.....	64
LK 831 ThermoMix@ B.....	67
LK 840 ThermoMix@ 2.0.....	69
LK 840 ThermoMix@ C.....	73
LK 841 ThermoMix@ 2.0.....	75
LK 842 ThermoMix@ P.....	78
LK 843 ThermoMix@.....	80
LK 850 ThermoMix@ H.....	82
LK 851 ThermoMix@ H.....	84

Temperature Controllers and Valve Actuators

LK SmartComfort.....	88
LK 941 EasyMix.....	92
LK 950 Valve Actuator.....	93
Mounting kits.....	94



Differential Temperature Controllers

LK 150 SmartSol.....	96
LK 160 SmartBio@.....	98
LK 162 SmartStove.....	101



Zone Valves

Design your own valve.....	104
Quick-coupling solutions.....	106
LK 525 MultiZone 2W.....	107
LK 525 MultiZone 3R.....	110
LK 525 MultiZone 3W.....	112
LK 527 MultiZone 2W.....	116
LK 527 MultiZone 3W.....	118



Filling Valves

LK 321 MultiFill® Solar.....	122
LK 521 MultiFill®.....	123
LK 538 ThermoFill EA.....	125
LK 539 ThermoFill EA.....	127



Valves for Water Heating

LK 510/511/512 MultiSafe.....	130
LK 514 MultiSafe.....	132
LK 322 CoolUnit.....	133
LK 548 AquaKit.....	134
LK 550 AquaMix.....	136
LK 551 HydroMix.....	138
LK 551 HydroMix F.....	141
LK 551 HydroKit Solar.....	143
LK 551 HydroKit HWC.....	145
LK 551 HWC CirculationKit.....	147
LK 552 HydroMix.....	148





Products for Underfloor Heating

LK 419 Manifold Shunt	152
LK 420 MiniShunt 2.0.....	153
LK 421 Manifold Shunt	155
LK 422 Manifold Shunt Tmax.....	157
LK 423 MiniLoop RTC.....	159
LK 430 Manifold.....	161
LK 435 OptiFlow.....	163
LK 440 EasyHeat.....	165
LK 450 EasyHeat P.....	166
LK 450 EasyHeat M.....	168



Other Products

LK 315 BallValve	172
LK 360 NetMag.....	173
LK 519 ThermoSafe.....	174
LK 522 FilterBall	175
LK 522 FilterBall Magnet	178
LK 556 AntiFreeze.....	181
LK 700/705 AeroMat.....	182
LK 924/925 SafetyGroup.....	183
LK 994 SafetyGroup.....	185
LK MultiConnection.....	186
Prefabricated pipes.....	188
Transition Fittings.....	190
Prefab.....	192



Company Information

New products	4
Social media.....	48
Exhibitions.....	120
Sustainability.....	194
LK Group.....	196
LK Armatur.....	197

LK Armatur - Your Partner for Heating and Hot Water Solutions

At LK Armatur, we're more than just a valve manufacturer; we're your partner in creating efficient heating and hot water solutions. With millions of valves produced annually, we understand how every component interacts in your unique applications. From standard products to custom solutions in Valves, Electronic Heat Regulation, Prefabrication, and Accessories, we're here to meet your specific needs. Our focus on energy efficiency and environmental responsibility helps you address the challenges of energy shortages and climate change. Choose LK Armatur for quality, customization, and reliability in every project.

Loading Units

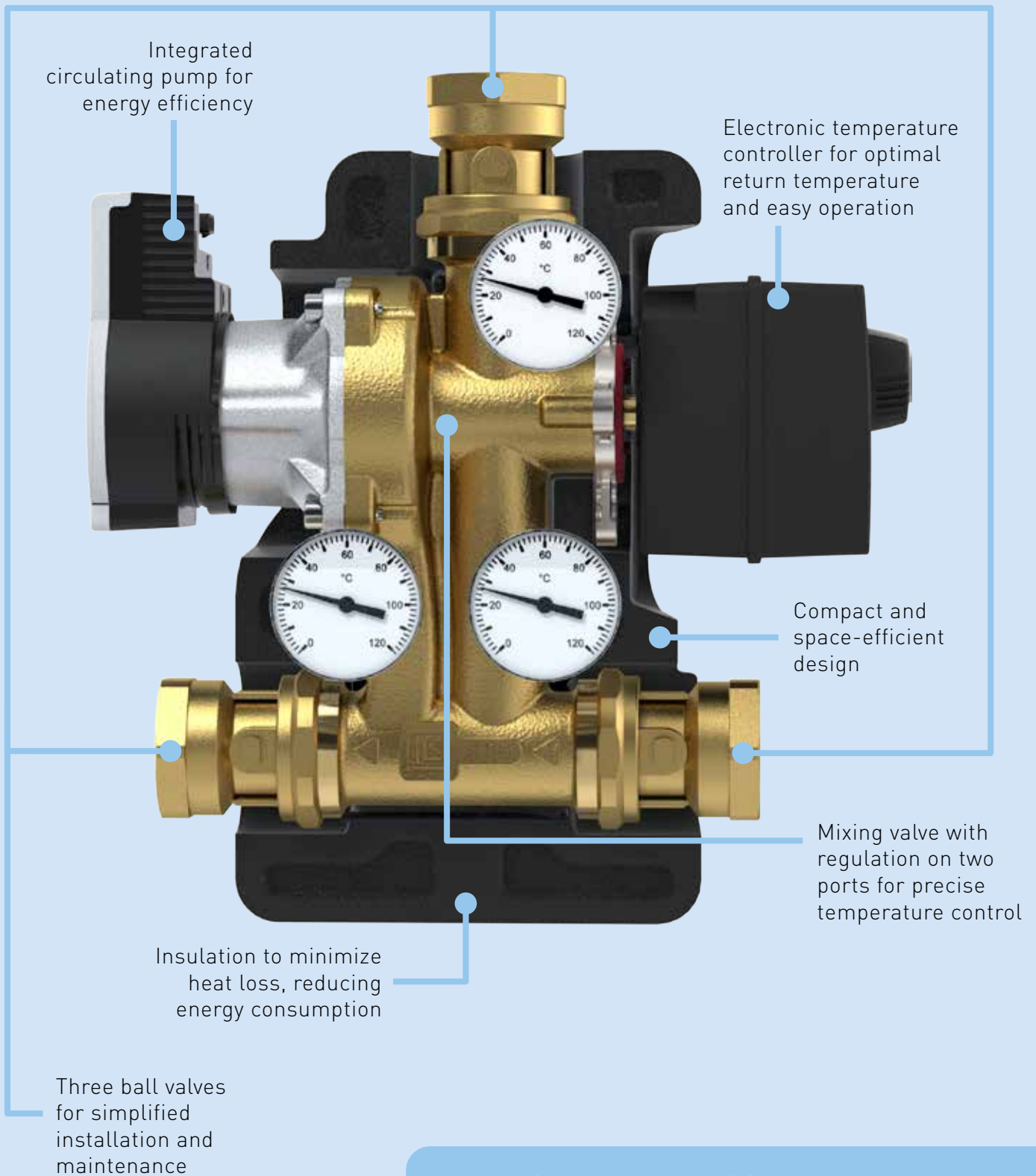

The **LK 811 ThermoMat 2.0 W** loading unit is your solution for improved heating performance. Designed for use with solid fuel boilers and storage tanks, this compact unit maintains high return temperature, extending the life of your boiler. Install with ease between your solid fuel boiler and storage tank, making it adaptable to your system's needs.

Loading units

LK 810 ThermoMat 2.0

- Improved regulation
- Compact design
- High efficiency pump from Grundfos / Wilo



TECHNICAL DATA

Voltage	230 VAC 50 Hz
Power consumption	G: 5-52 W, depending on pump speed W: 3-75 W, depending on pump speed
Max. boiler efficiency	65 kW at 20 °C ΔT
Max. working pressure	0.6 MPa (6 bar)
Working temperature	G: Min. 5 °C/Max. 110 °C W: Min. 5 °C/Max. 95 °C
Return temperature	55 °C, 60 °C, 65 °C or 70 °C
Ambient temperature	G: Min. 0 °C/Max. 70 °C W: Min. 5 °C/Max. 60 °C
Thread standard	Rp - female thread
Media	Water - Glycol mixture max. 50%
Circulating pump	Wilo Para * /8 SC FS14, Grundfos UPM3 AUTO xx-70
Material, valve body	Brass EN 1982 CB753S
Material, insulation	Expanded Polypropylene EPP

LK 810 ThermoMat 2.0 is a loading unit for heating applications with solid fuel boilers and storage tanks. The loading unit is intended to ensure a high return temperature as well as an optimal temperature stratification in the storage tank, thus increasing the efficiency of the system. Tarring and condensation are prevented which prolongs boiler life.

The LK 810 ThermoMat 2.0 is a compact design with an integrated low-energy circulating pump and a thermic loading valve that regulates on two ports. The loading unit has three ball valves to simplify installation and maintenance, three thermometers that allow for simple control of the loading process and an insulation to minimize heat loss. The loading unit is available in two versions - with or without check valve. With a check valve the functions described under phase 4 will be obtained.

LK 810 ThermoMat 2.0 is also available with a circulating pump that is controlled by a PWM-signal. For more information please contact our sales department.

LK 810 ThermoMat 2.0 is installed in the return circuit between the solid fuel boiler and the storage tank. The unit should be mounted upright with the drive-shaft of the circulating pump in a horizontal position. The loading unit is reversible and can easily be adapted for mounting to the right or left of the boiler.

The loading unit normally requires no maintenance. The installation should be checked regularly. Thanks to the three ball valves any part can be changed without draining the system in case of servicing.

THE FUNCTION OF THE LOADING UNIT DURING THE DIFFERENT PHASES OF HEATING:

1. HEAT UP PHASE

The water circulates between boiler and loading unit while the temperature of the boiler is rising.

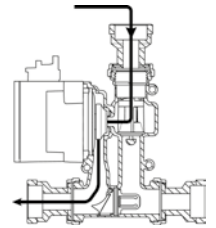

2. LOADING PHASE

The thermostatic element starts to open and allows return water from the storage tank to be mixed with supply water before it returns to the boiler. The return temperature to the boiler is kept constant.

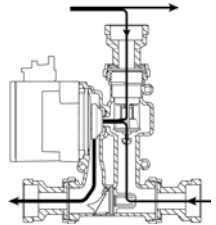

3. END PHASE

The thermostatic element is fully open and the bypass is closed. This results in an optimal transfer of heat from the boiler and the storage tank is filled with supply water.

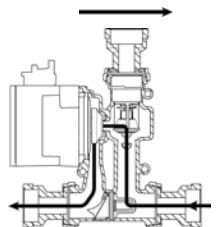

SELF-CIRCULATION WITH CHECK VALVE

Self-circulation will be obtained as soon as the fire has gone out and the circulating pump has stopped. The remaining hot water is loaded to the storage tank. In case of power failure or pump breakdown the check valve automatically opens to allow self-circulation. The check valve also stops recirculation from storage tank to boiler.

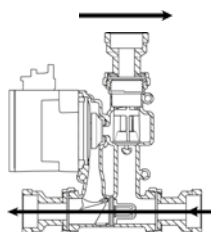

WITH CHECK VALVE

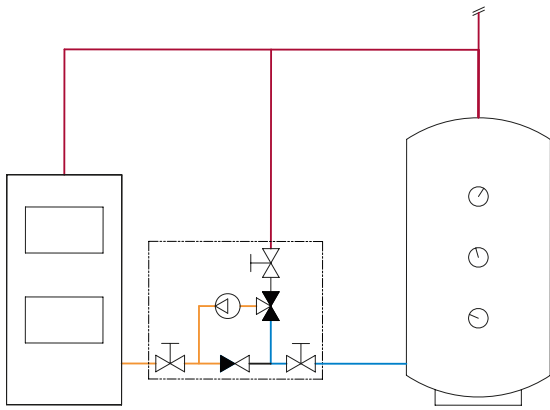

WITHOUT CHECK VALVE

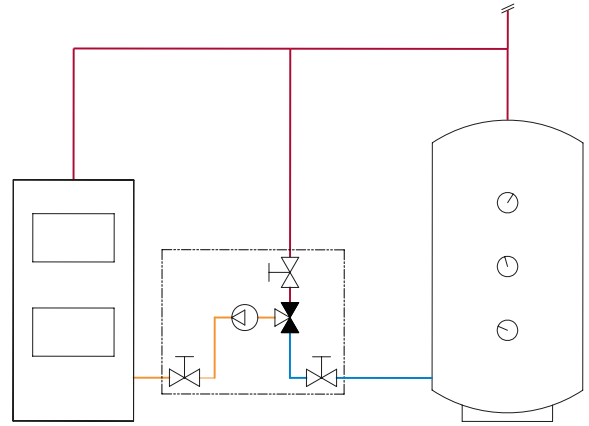

PUMP CHARACTERISTICS - GRUNDFOS UPM3 AUTO XX-70

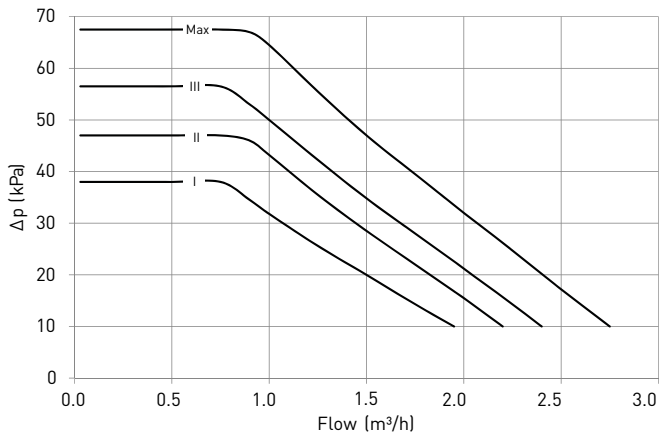

PUMP CHARACTERISTICS - WILO PARA */8 SC FS14

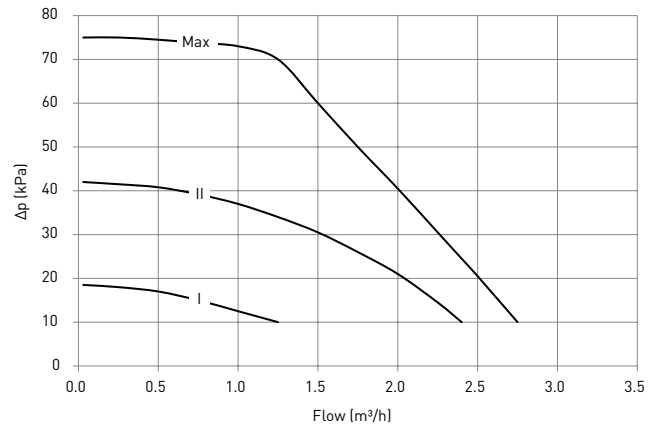

BOILER CAPACITY DIAGRAM - GRUNDFOS UPM3 AUTO XX-70

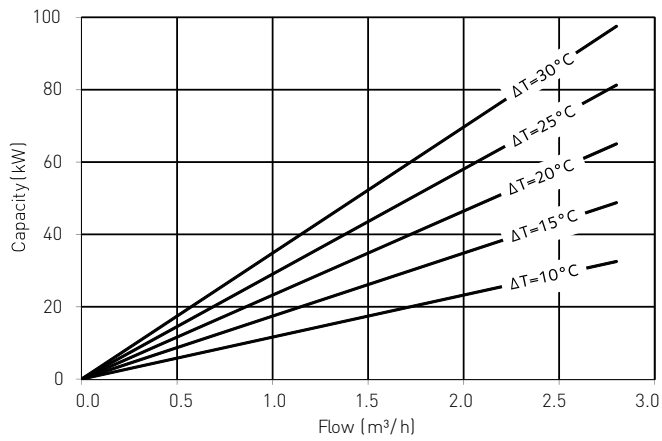

BOILER CAPACITY DIAGRAM - WILO PARA */8 SC FS14

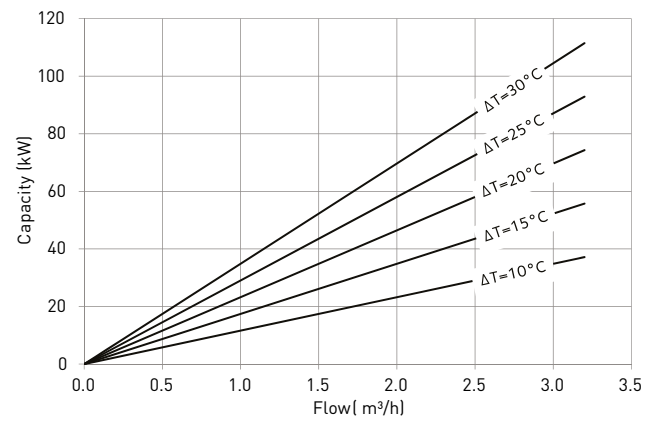

LK 810 2.0 Grundfos - Compression fitting

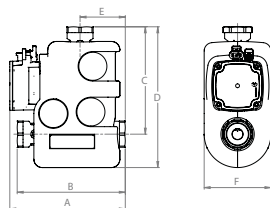

Article no.	Type	Return temp.	Dim.	A mm	B mm	C mm	D mm	E mm	F mm	Weight kg
181644	with check valve	55°C	28 mm	208	195	195	255	82	120	4.0
181650	with check valve	60°C	28 mm	208	195	195	255	82	120	4.0

Other temperatures and dimensions on request.

LK 810 2.0 Grundfos - Female thread

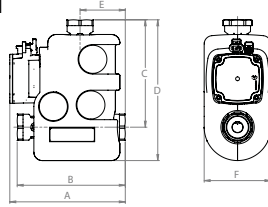

Article no.	Type	Return temp.	Dim.	A mm	B mm	C mm	D mm	E mm	F mm	Weight kg
181640	with check valve	55°C	F 1"	208	195	195	255	82	120	4.0
181642	with check valve	55°C	F 1¼"	208	195	195	255	82	120	4.0
181646	with check valve	60°C	F 1"	208	195	195	255	82	120	4.0
181648	with check valve	60°C	F 1¼"	208	195	195	255	82	120	4.0
181651	without check valve	65°C	F 1"	208	195	195	255	82	120	4.0
181652	with check valve	65°C	F 1"	208	195	195	255	82	120	4.0
181654	with check valve	65°C	F 1¼"	208	195	195	255	82	120	4.0
181658	with check valve	70°C	F 1"	208	195	195	255	82	120	4.0
181660	with check valve	70°C	F 1¼"	208	195	195	255	82	120	4.0

Other temperatures and dimensions on request.

LK 810 2.0 Grundfos - Female thread

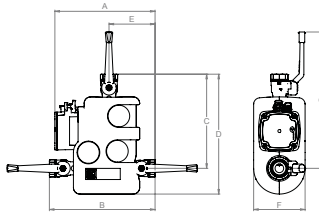

Article no.	Type	Return temp.	Dim.	A mm	B mm	C mm	D mm	E mm	F mm	G mm	Weight kg
181839	with check valve	55°C	F 1"	234	247	222	282	108	120	300	4.0
181840	without check valve	55°C	F 1"	234	247	222	282	108	120	300	4.0
181825	with check valve	60°C	F 1"	234	247	222	282	108	120	300	4.0
181841	without check valve	60°C	F 1"	234	247	222	282	108	120	300	4.0
181827	with check valve	65°C	F 1"	234	247	220	280	108	120	300	4.0
181842	without check valve	65°C	F 1"	234	247	222	282	108	120	300	4.0
181829	with check valve	70°C	F 1"	234	247	222	282	108	120	300	4.0
181843	without check valve	70°C	F 1"	234	247	222	282	108	120	300	4.0
182352	with check valve	55°C	F 1¼"	234	247	222	282	108	120	300	4.0
182353	without check valve	55°C	F 1¼"	234	247	222	282	108	120	300	4.0
182354	with check valve	60°C	F 1¼"	234	247	222	282	108	120	300	4.0
182355	without check valve	60°C	F 1¼"	234	247	222	282	108	120	300	4.0
182356	with check valve	65°C	F 1¼"	234	247	222	282	108	120	300	4.0
182357	without check valve	65°C	F 1¼"	234	247	222	282	108	120	300	4.0
182358	with check valve	70°C	F 1¼"	234	247	222	282	108	120	300	4.0
182359	without check valve	70°C	F 1¼"	234	247	222	282	108	120	300	4.0

LK 810 2.0 Wilo - Female thread

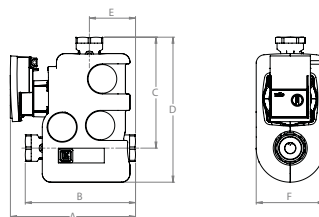

Article no.	Type	Return temp.	Dim.	A mm	B mm	C mm	D mm	E mm	F mm	Weight kg
181664	with check valve	55°C	F 1"	216	195	195	255	82	120	4.0
181669	without check valve	60°C	F 1"	216	195	195	255	82	120	4.0

Other temperatures and dimensions on request.

LK 810 2.0 Wilo - Female thread

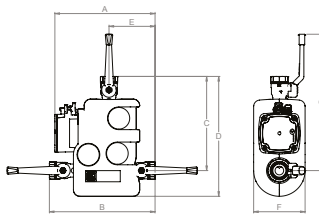

Article no.	Type	Return temp.	Dim.	A mm	B mm	C mm	D mm	E mm	F mm	G mm	Weight kg
181844	with check valve	55°C	F 1"	248	250	222	282	108	120	302	4.0
181848	without check valve	55°C	F 1"	248	250	222	282	108	120	302	4.0
181845	with check valve	60°C	F 1"	248	250	222	282	108	120	302	4.0
181849	without check valve	60°C	F 1"	248	250	222	282	108	120	302	4.0
181846	with check valve	65°C	F 1"	248	250	222	282	108	120	302	4.0
181850	without check valve	65°C	F 1"	248	250	222	282	108	120	302	4.0
181847	with check valve	70°C	F 1"	248	250	222	282	108	120	302	4.0
181851	without check valve	70°C	F 1"	248	250	222	282	108	120	302	4.0
182360	with check valve	55°C	F 1¼"	248	279	238	282	124	120	302	4.0
182361	without check valve	55°C	F 1¼"	248	279	238	282	124	120	302	4.0
182362	with check valve	60°C	F 1¼"	248	279	238	282	124	120	302	4.0
182363	without check valve	60°C	F 1¼"	248	279	238	282	124	120	302	4.0
182364	with check valve	65°C	F 1¼"	248	279	238	282	124	120	302	4.0
182365	without check valve	65°C	F 1¼"	248	279	238	282	124	120	302	4.0
182366	with check valve	70°C	F 1¼"	248	279	238	282	124	120	302	4.0
182367	without check valve	70°C	F 1¼"	248	279	238	282	124	120	302	4.0

SPARE PARTS AND ACCESSORIES

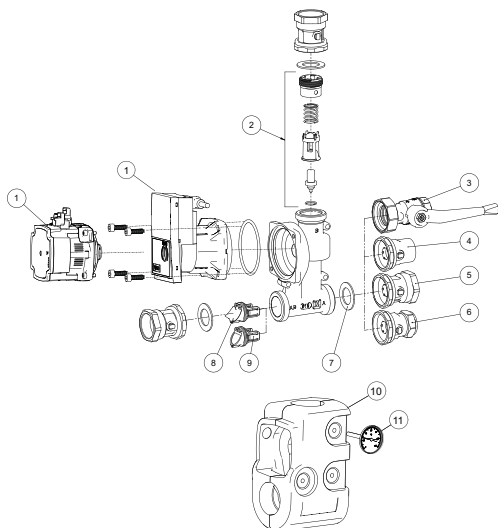

Article no.	Article	Position
187168	Grundfos UPM3 Auto xx-70	1
187347	Wilo Para */8 SC FS14	1
187163	Thermostatic element 55 °C	2
187164	Thermostatic element 60 °C	2
187165	Thermostatic element 65 °C	2
187166	Thermostatic element 70 °C	2
055577	Ball valve F 1" with handles	3
187329	Ball valve F 1¼" with handles	3
187017	Ball valve F 1"	4
187018	Ball valve F 1¼"	5
187019	Ball valve 28 mm	6
013057	Sealing EPDM 44x32x2 mm	7
187021	Check valve 810 / 811	8
187022	Plug 810 / 811	9
187167	EPP Insulation	10
180352	Thermometer 120 °C	11

Loading units

LK 811 ThermoMat 2.0 W

- Adjustable return temperature
- Electronic regulation ensures an easy operation



TECHNICAL DATA

Voltage	230 VAC 50 Hz
Power consumption	10-75 W, depending on pump speed
Max. boiler efficiency	65 kW at 20 °C ΔT
Max. working pressure	0.6 MPa (6 bar)
Working temperature	Min. 5 °C/Max. 95 °C
Return temperature	5-99 °C with LK 100 SmartComfort CT
Ambient temperature	Min. 5 °C/Max. 60 °C
Thread standard	Rp - female thread
Media	Water - Glycol mixture max. 50%
Circulating pump	Wilo Para */6 SC FS14 Wilo Para */8 SC FS14
Material, valve body	Brass EN 1982 CB753S
Material, insulation	Expanded Polypropylene EPP

LK 811 ThermoMat 2.0 W is a loading unit for heating applications with solid fuel boilers and storage tanks. The loading unit is intended to ensure a high return temperature as well as an optimal temperature stratification in the storage tank, thus increasing the efficiency of the system. Tarring and condensation are prevented which prolongs boiler life.

The LK 811 ThermoMat 2.0 W is a compact design with an integrated low-energy circulating pump and a mixing valve that regulates on two ports. The loading unit has three ball valves to simplify installation and maintenance and an insulation to minimize heat loss. Three thermometers that allow for simple control of the loading process can be ordered as accessories. The loading unit is available in two versions - with or without check valve. With a check valve the functions described under phase 4 will be obtained.

LK 811 ThermoMat 2.0 W is available with or without an electronic temperature controller. Mounting kits for controllers of other brands are available - see section Temperature Controllers - Mounting Kits.

LK 811 ThermoMat 2.0 W is installed in the return circuit between the solid fuel boiler and the storage tank. The unit should be mounted upright with the drive-shaft of the circulating pump in a horizontal position. The loading unit is reversible and can easily be adapted for mounting to the right or left of the boiler.

The loading unit normally requires no maintenance. The installation should be checked regularly. Thanks to the three ball valves any part can be changed without draining the system in case of servicing.

Please contact our Sales Department for more information.

THE FUNCTION OF THE LOADING UNIT DURING THE DIFFERENT PHASES OF HEATING:

1. HEAT UP PHASE

The water circulates between boiler and loading unit while the temperature of the boiler is rising.

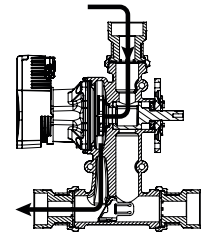

2. LOADING PHASE

The electronic temperature controller starts to open the mixing valve at the chosen temperature and allows return water from the storage tank to be mixed with supply water before it returns to the boiler. The return temperature to the boiler is kept constant.

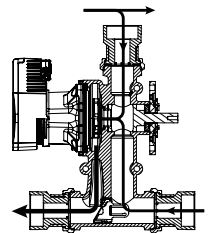

3. END PHASE

The mixing valve is fully open towards the storage tank. This results in an optimal transfer of heat from the boiler and the storage tank is filled with supply water. When the boiler has cooled the electronic controller LK 100 SmartComfort CT prevents re-circulation from storage tank to boiler.

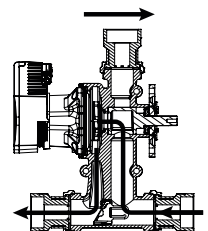

4. SELF-CIRCULATION WITH CHECK VALVE

Self-circulation will be obtained as soon as the fire has gone out and the circulating pump has stopped. The remaining hot water is loaded to the storage tank. In case of power failure or pump breakdown the check valve automatically opens to allow self-circulation. The check valve also stops recirculation from storage tank to boiler.

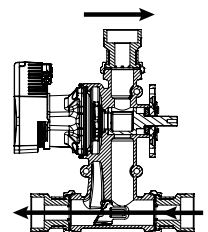

BOILER CAPACITY DIAGRAM, WILO PARA*/6 SC FS14

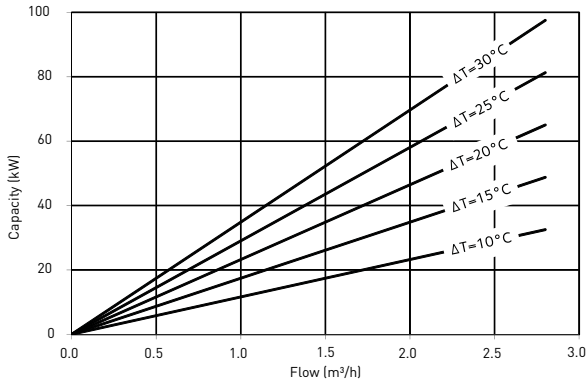

BOILER CAPACITY DIAGRAM - WILO PARA */8 SC FS14

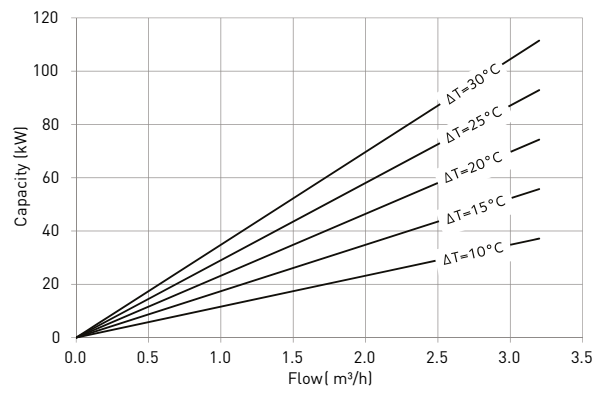

PUMP CHARACTERISTICS, WILO PARA */6 SC FS14

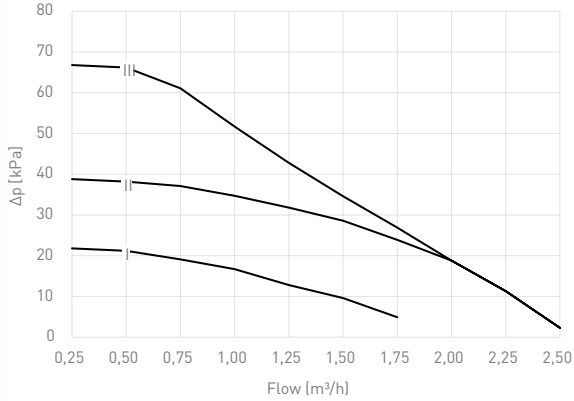

PUMP CHARACTERISTICS, WILO PARA */8 SC FS14

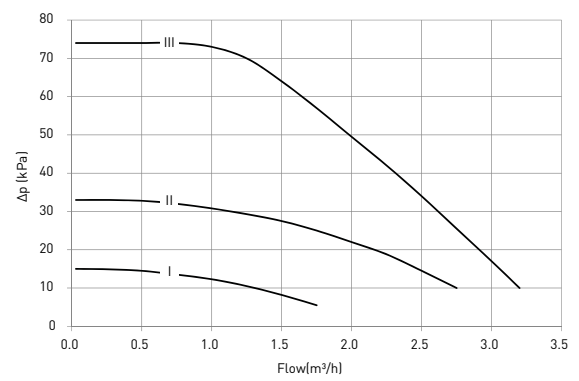

WITHOUT CHECK VALVE

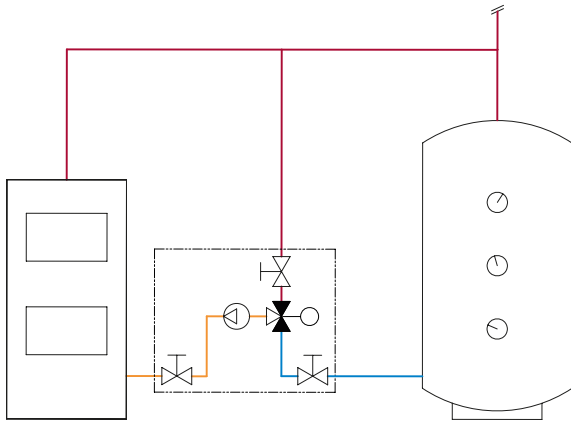

WITH CHECK VALVE

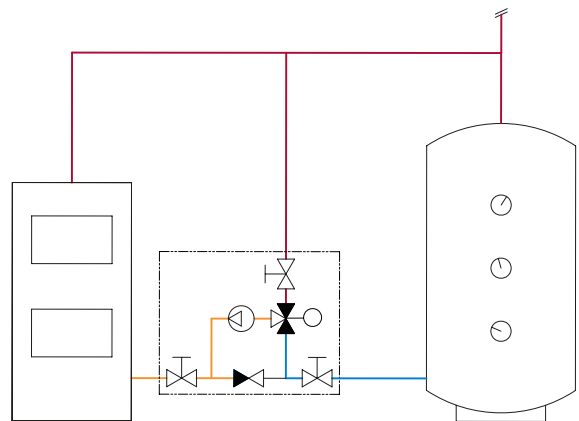

SPARE PARTS AND ACCESSORIES

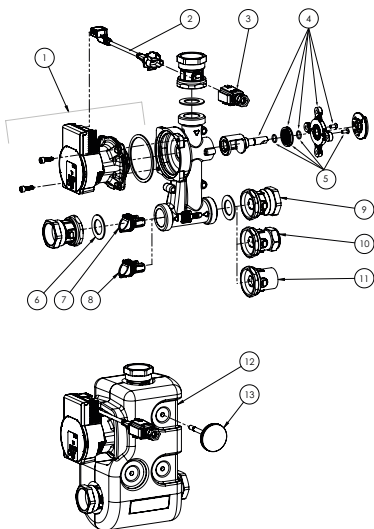

Article no.	Article	Position
187347	Wilo Para */8 SC FS14	1
187960	Wilo Para */6 SC FS14	1
095451	Cable for SmartComfort, 15 m	2
095220	Connector	3
187110	Repair kit 811	4
187066	Sealing kit 811/840/841, DN 15-20	5
013025	Gasket EPDM 1½" - Ø44 x Ø27 x 2 mm	6
187021	Check valve 810 / 811	7
187022	Plug 810 / 811	8
187018	Ball valve F 1¼"	9
187019	Ball valve 28 mm	10
187017	Ball valve F 1"	11
187351	EPP Insulation, 811	12
058126	Thermometer 120 °C	13

Loading units

LK 815 ThermoKit T Eco



- Complete kit
- Low-energy pump



TECHNICAL DATA

Voltage	230 VAC 50/60 Hz
Power consumption	12-140 W depending on pump speed
Max. boiler efficiency	140 kW at 20 °C ΔT
Max. flow	5900 l/h
Max. working pressure	1.0 MPa (10 bar)
Working temperature	Min. 5 °C/Max. 95 °C
Return temperature	45 °C, 50 °C, 55 °C, 60 °C, 65 °C or 70 °C
Ambient temperature	Min. 5 °C/Max. 40 °C
Thread standard	Rp - female thread, G - female thread
Media	Water - Glycol mixture max. 50%
Circulating pump	Grundfos UPML 25-95 180
Material, valve body	Brass EN 1982 CB753S
Material, insulation	Expanded Polypropylene EPP

LK 815 ThermoKit T Eco is a loading group for heating applications with solid fuel boilers and storage tanks. The loading group is intended to ensure a high return temperature as well as an optimal temperature stratification in the storage tank, thus increasing the efficiency of the system. Tarring and condensation are prevented which prolongs boiler life.

LK 815 ThermoKit T Eco consists of a low-energy circulating pump, an LK 823 ThermoVar thermic loading valve with insulation, a check valve, a thermometer for reading return temperature and three ball valves to simplify installation and maintenance.

LK 815 ThermoKit T Eco is installed in the return circuit between the solid fuel boiler and the storage tank. The group should be mounted with the drive-shaft of the circulating pump in a horizontal position. The loading group is reversible and can easily be adapted for mounting to the right or left of the boiler.

Thermometers are available as accessory, art. no. 181736.

The loading group normally requires no maintenance. The installation should be checked regularly. Thanks to the three ball valves any part can be changed without draining the system, if the need for servicing arise.

THE FUNCTION OF THE LOADING UNIT DURING THE DIFFERENT PHASES OF HEATING:

1. HEAT UP PHASE

The water circulates between boiler and loading group while the temperature of the boiler is rising.

2. LOADING PHASE

The thermic valve starts to open and allows return water from the storage tank to be mixed with supply water before it returns to the boiler. The return temperature to the boiler is kept constant.

3. END PHASE

The thermostatic element is fully open. This results in an optimal transfer of heat from the boiler and the storage tank is filled with supply water.

4. SELF-CIRCULATION

As soon as the fire has gone out and the circulating pump has stopped the remaining hot water in the boiler is loaded to the storage tank as long as the thermic valve remains open. When the boiler has cooled the thermic valve closes. The check valve prevents recirculation from storage tank to boiler.

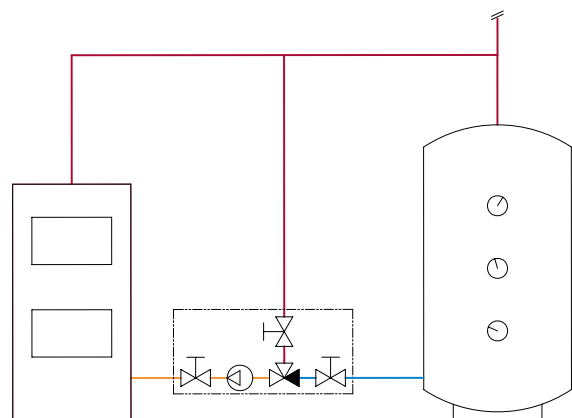

BOILER CAPACITY DIAGRAM

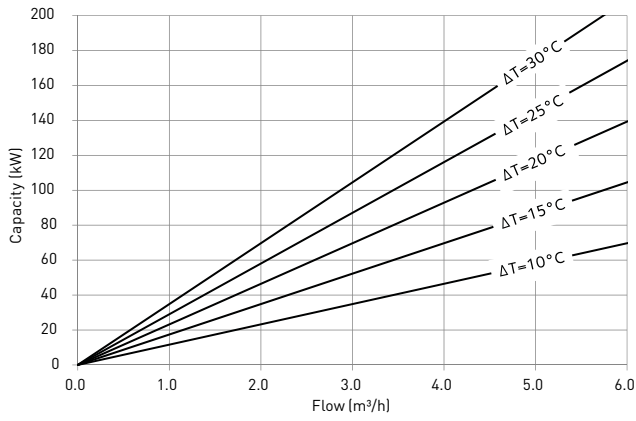

PUMP CHARACTERISTICS

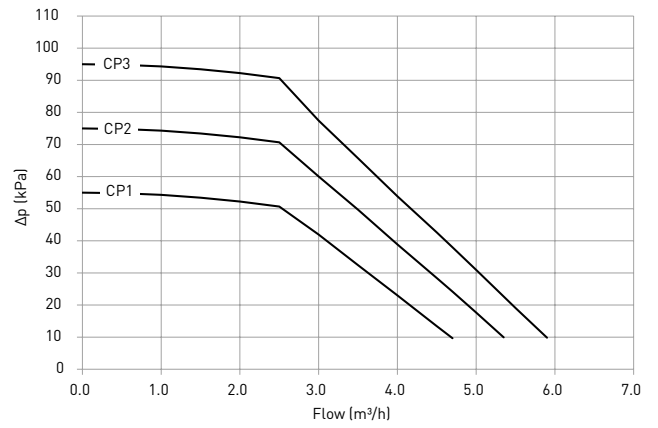

LK 815 - Grundfos UPML 25-95 - Female thread

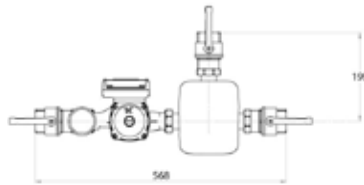

Article no.	Return temp.	Dim.	Weight kg
181572	45°C	F 1½"	7.1
181573	50°C	F 1½"	7.1
181574	55°C	F 1½"	7.1
181575	60°C	F 1½"	7.1
181576	65°C	F 1½"	7.1
181577	70°C	F 1½"	7.1

LK 815 - Grundfos UPML 25-95 - Female thread

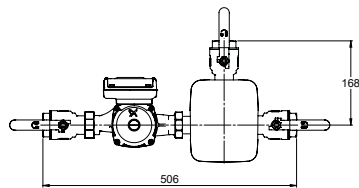

Article no.	Return temp.	Dim.	Weight kg
182390	45°C	F 1¼"	7.1
182391	50°C	F 1¼"	7.1
182392	55°C	F 1¼"	7.1
182393	60°C	F 1¼"	7.1
182394	65°C	F 1¼"	7.1
182395	70°C	F 1¼"	7.1

Loading units

LK 816 ThermoKit E Eco



- Complete kit
- Low-energy pump



TECHNICAL DATA

Voltage	230 VAC 50/60 Hz
Power consumption	10-180 W depending on pump speed LK 100 SmartComfort CT Electronic Controller, 3 VA
Primary voltage, adapter	100-240 VAC 50/60 Hz
Secondary voltage, adapter	24 VDC 250 mA
Max. boiler efficiency	Dependent on circulating pump
Max. flow	Dependent on circulating pump
Angle of rotation	Temperature Controller: 90°
Torque	Temperature Controller: 5 Nm
Operation time	140 sec.
Max. working pressure	1.0 MPa (10 bar)
Working temperature	Min. 5 °C/Max. 95 °C
Return temperature	5 - 99 °C
Ambient temperature	Min. 5 °C/Max. 40 °C
Thread standard	Rp - female thread, G - female thread
Protection class	IP 40
Media	Water - Glycol mixture max. 50%
Circulating pump	Grundfos Magna 32-80 180, Grundfos UPML 25-95 180, Grundfos UPMXL 32-105 180
Material, valve body	Brass EN 12165 CW617N
Material, insulation	Expanded Polypropylene EPP

LK 816 ThermoKit E Eco is a loading group for heating applications with solid fuel boilers and storage tanks. The loading group is intended to ensure a high return temperature as well as an optimal temperature stratification in the storage tank, thus increasing the efficiency of the system. Tarring and condensation are prevented which prolongs boiler life.

LK 816 ThermoKit E Eco is a unit consisting of a low-energy circulating pump, an LK 840 ThermoMix mixing valve, an LK 100 SmartComfort CT controller with adjustment of the lowest return temperature 5 - 99 °C and three ball valves to simplify installation and maintenance. Articles number 181578 and 181579 are delivered with an insulation for the mixing valve.

LK 816 ThermoKit E Eco is installed in the return circuit between the solid fuel boiler and the storage tank. The group should be mounted with the drive-shaft of the circulating pump in a horizontal position. The loading group is reversible and can easily be adapted for mounting to the right or left of the boiler.

The loading group normally requires no maintenance. The installation should be checked regularly. Thanks to the three ball valves any part can be changed without draining the system, should the need for servicing arise.

THE FUNCTION OF THE LOADING UNIT DURING THE DIFFERENT PHASES OF HEATING:

1. HEAT UP PHASE

The water circulates between boiler and loading group while the temperature of the boiler is rising.

2. LOADING PHASE

The mixing valve starts to open and allows return water from the storage tank to be mixed with supply water before it returns to the boiler. The return temperature to the boiler is kept constant.

3. END PHASE

The mixing valve is fully open towards the storage tank. This results in an optimal transfer of heat from the boiler and the storage tank is filled with supply water. When the boiler has cooled the electronic controller prevents re-circulation from storage tank to boiler.

4. SELF-CIRCULATION

In case of power failure or pump breakdown the electronic controller can be manually operated and the storage tank is loaded through self-circulation.

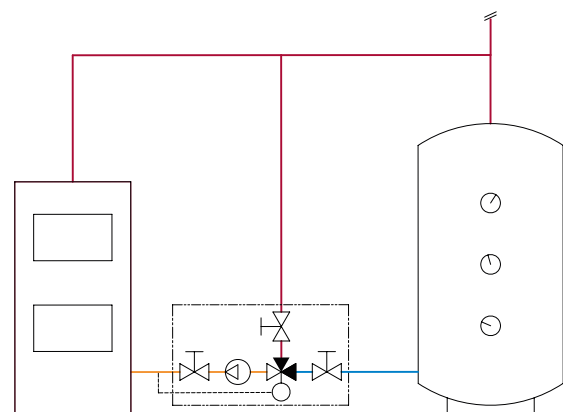

BOILER CAPACITY DIAGRAM

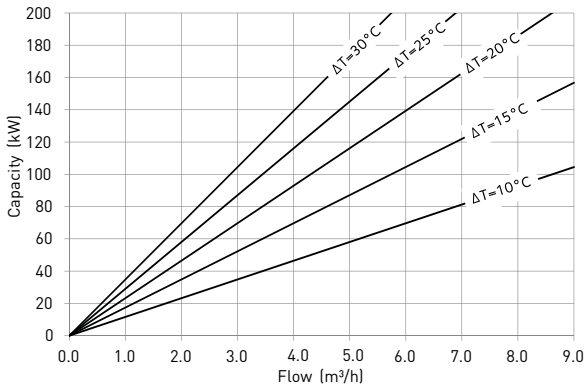

LK 816 - Grundfos UPML 25-95 - Female thread

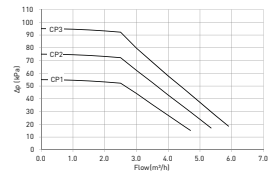
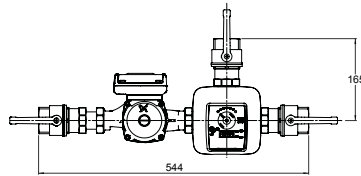

Article no.	Dim.	Note	Weight kg
181578	F 1½"	Adapter - EU	7.1
181579	F 1½"	Adapter - UK	7.1

LK 816 - Grundfos UPML 25-95 - Female thread

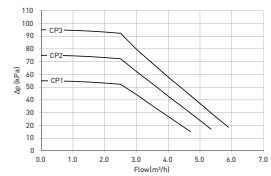
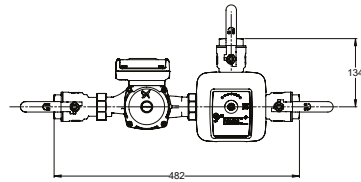

Article no.	Dim.	Note	Weight kg
182396	F 1¼"	Adapter - EU	7.1
182397	F 1¼"	Adapter - UK	7.1

LK 816 - Grundfos UPMXL 32-105 - Female thread

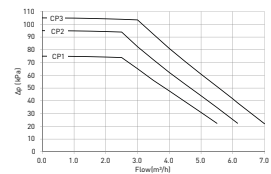
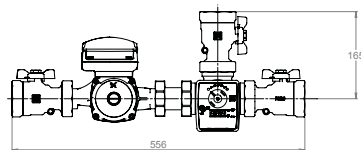

Article no.	Dim.	Note	Weight kg
181580	F 2"	Adapter - EU	11.1
181581	F 2"	Adapter - UK	11.1

LK 816 - Grundfos Magna 32-80 - Female thread

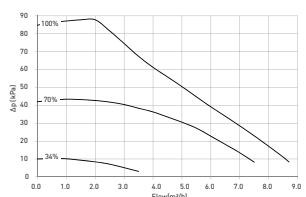
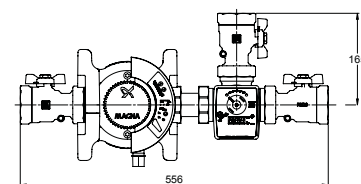

Article no.	Dim.	Note	Weight kg
181410	F 2"	Adapter - EU	12.4
181582	F 2"	Adapter - UK	12.4



Correct temperature - of course!



Pumpgroup HydronicGroup ensures you have the right temperature in your home.

Pump Groups

The system is designed with an external 1½ connection for easy and quick installation on the boiler's flow and return lines

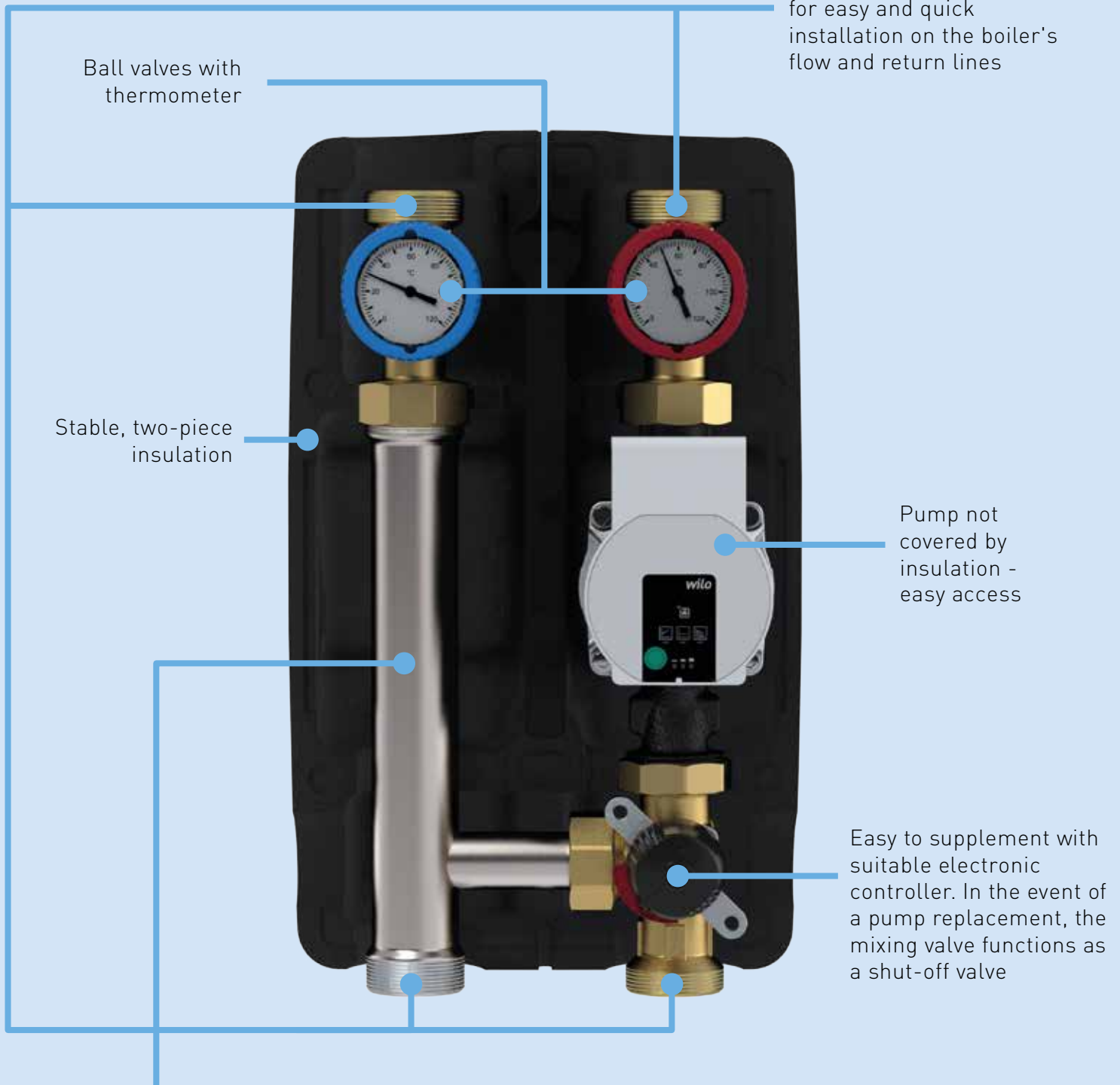

Ball valves with thermometer

Stable, two-piece insulation

Pump not covered by insulation - easy access

Easy to supplement with suitable electronic controller. In the event of a pump replacement, the mixing valve functions as a shut-off valve

Integrated check valve to prevent self-circulation, also serves as a gasket between ball valve and pipe

Efficient, versatile, and easy to install, **LK HydronicGroup C/C 125** is the answer to your heating needs. With a high-performance circulation pump, insulation, two ball valves with a thermometer, and a wall mounting bracket, it's a complete package for direct or mixed supply heating systems. The product you see pictured is our **LK 862 R** pump group, which includes a three-way mixing valve for mixed supply.



More than one heating system in your property?

Our pump group is available as various installations, depending on your needs.

If you've more than one heating system in your property, you can easily connect up to four different pump groups. Our pump groups can easily be placed individually and in a group of up to four units. With our electronic controller, SmartComfort, installed on the pump group, the system will be provided with the exact amount of heat required in the building at any given time. You can easily read the temperature on the integrated thermometers.

- All in one
- Easy to install
- Easy to combine with electronic regulation

Choose according to your needs:

LK 860 - MANIFOLD

LK 861 - DIRECT SUPPLY

LK 862 - MIXED SUPPLY

Three-way mixing valve is included.

LK 863 - MIXED SUPPLY

Thermic mixing valve, LK 551 HydroMix, is included.

LK 864 - LOADING UNIT

Thermic loading valve LK 823 ThermoVar® is included to ensure both an optimal temperature stratification in the accumulator tank and a high return temperature to the boiler, which increases the system's efficiency.

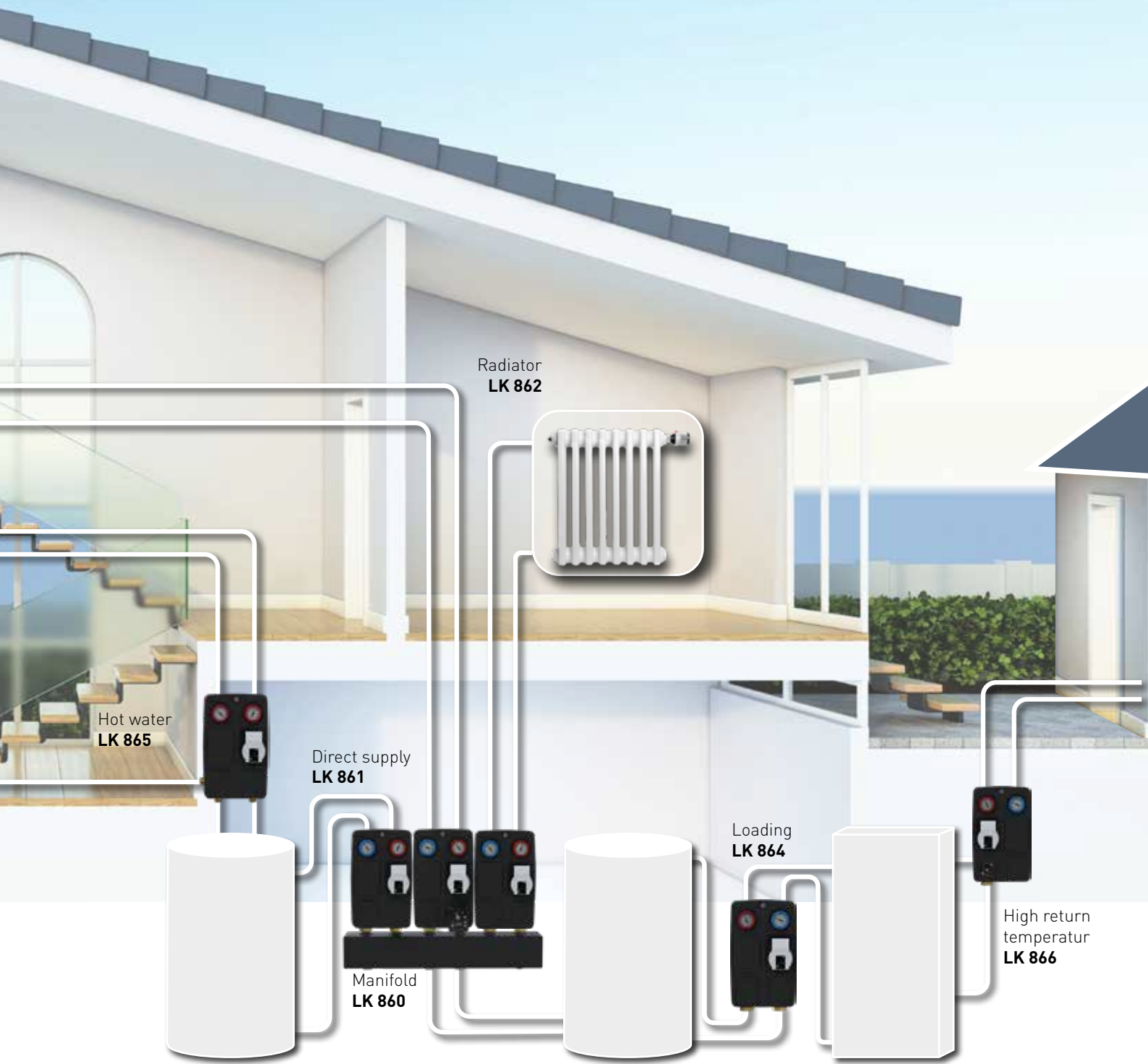

LK 865 - COMPLETE UNIT FOR HOT WATER CIRCULATION

Thermic mixing valve LK 551 HydroMix HWC is included.

LK 866 - HIGH RETURN TEMPERATUR

A four way mixing valve LK 841 ThermoMix® is included. Designed for heating systems where a high return temperature is required to prevent corrosion and thus extend the life length of the heat source.

LK 867 - FOR TWO HEATING UNITS

A bivalent mixing valve LK 830 ThermoMix® is included. Designed for heating systems, where energy is taken from two heating units connected in series or parallel or for storage tank systems where energy is extracted from two levels.



Pump groups

LK HydronicGroup 90C

- Adapted for cold
- Easy to install
- Easy to combine with electronic regulation



TECHNICAL DATA

Voltage	230 VAC 50/60 Hz
Power consumption	10-75 W, depending on pump speed
Leakage	< 0,2% of Kvs at 100 kPa
Max. working pressure	1.0 MPa (10 bar)
Working temperature	Min. -15 °C Supply temperature: Min. 5 °C
Ambient temperature	Min. 5 °C/Max. 58 °C
Thread standard	Rp - female thread
Media	Water - Glycol mixture max. 50%
Circulating pump	Wilo Para 15-130/8-75/SC-9
Material, valve body	Brass EN 12165 CW617N
Cooling efficiency	7 kW (ΔT 10 °C 10 l/min.)

LK HydronicGroup is a complete pump group that is suitable for cooling systems where mixed supply is desirable.

LK HydronicGroup comprises a high efficient circulation pump, insulation, wall mounting bracket and two ball valves with thermometer. In the model where mixed supply is desired, a three-way mixing valve is included.

CAPACITY DIAGRAM

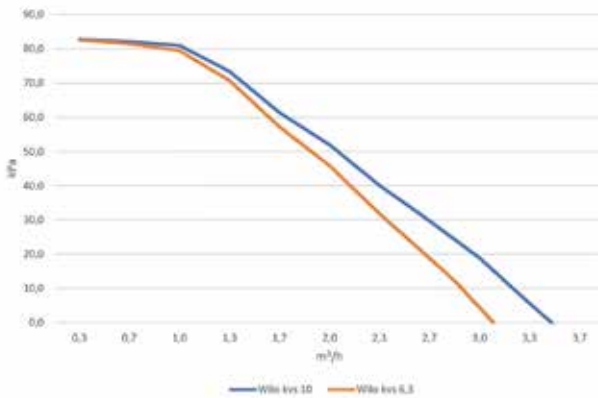

PUMP GROUP FOR PASSIVE COOLING

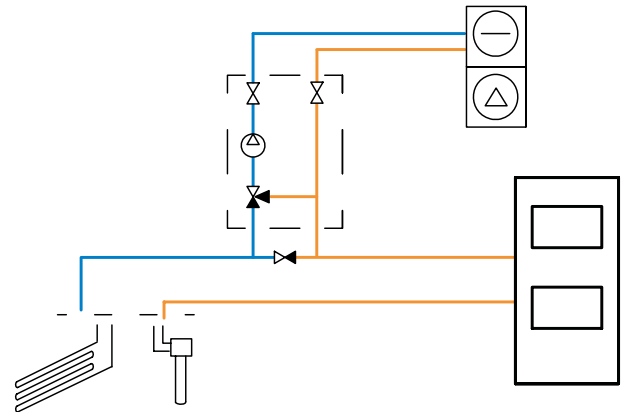

LK 90C - Pump group for passive cooling

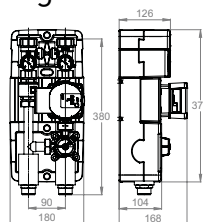

Article no.	Dim.	Kvs m³/h	Note	Weight kg
299387	F 1" x M 1"	6.3 /10.0	Wilo PARA 15-130/8-75/SC-9	4.0

Pump groups

LK HydronicGroup C/C 90

- All in one
- Easy to install
- Easy to combine with electronic regulation



TECHNICAL DATA

Voltage	230 VAC 50/60 Hz
Power consumption	10-75 W, depending on pump speed
Leakage	< 0,2% of Kvs at 100 kPa
Max. working pressure	1.0 MPa (10 bar)
Working temperature	Min. 5 °C/Max. 100 °C
Ambient temperature	Min. 5 °C/Max. 58 °C
Thread standard	Rp - female thread, G - male thread
Media	Wilo: Water - Glycol mixture max. 50%
Media 2	Taco: Water - Glycol mixture max. 30%
Circulating pump	Wilo Para 15-130/8-75/SC-9, Taco ES2C 15-70-130
Material, valve body	Brass EN 12165 CW617N
Material, insulation	Expanded Polypropylene EPP

LK HydronicGroup is a complete pump group that is suitable for heating systems where direct supply or mixed supply is desirable.

LK HydronicGroup comprises a high efficient circulation pump, insulation, wall mounting bracket and two ball valves with thermometer. In the model where mixed supply is desired, a three-way mixing valve is included.

A manifold for two, optionally three, pump groups is available as an accessory, see accessories and spare parts. Wall mounting bracket is not included with manifold, it must be ordered separately, see accessories and spare parts.

CAPACITY DIAGRAM

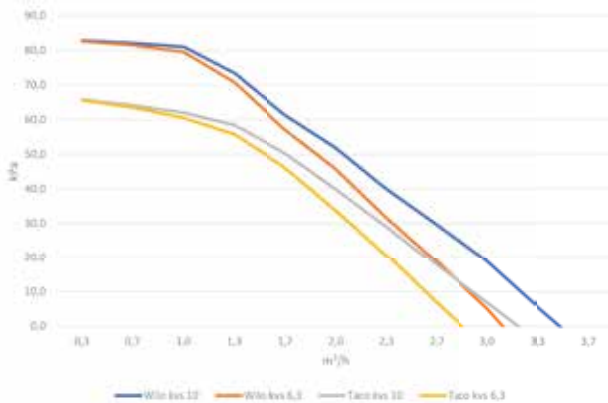

LK 861 RIGHT



LK 861 LEFT



PUMP GROUP WITH DIRECT SUPPLY

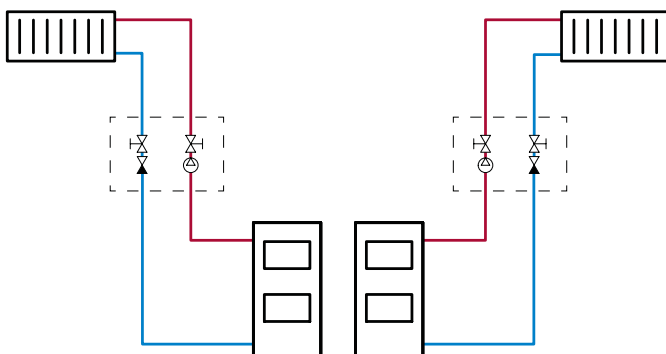

PUMP GROUP WITH MIXING VALVE

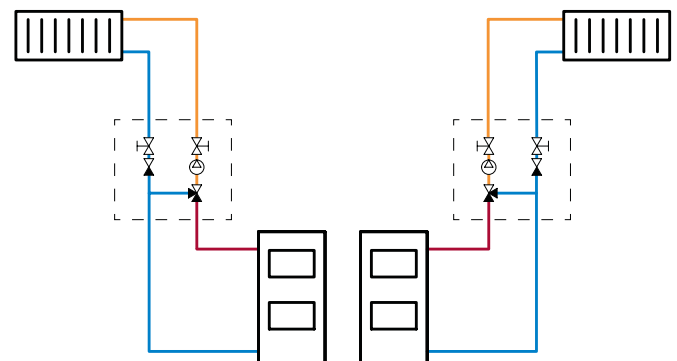

LK 860 - Manifold

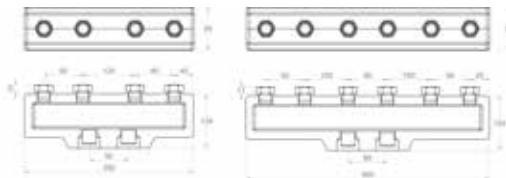

Article no.	Type	Dim.	Note	Weight kg
182125	Manifold 2 pc groups	F 1" x M 1"	0.3 MPa (3 Bar)	3.3
182126	Manifold 3 pc groups	M 1" x F 1"	0.3 MPa (3 Bar)	4.5

LK 861 - Pump group with direct supply

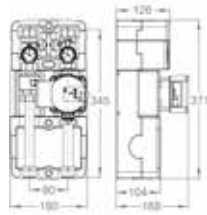

Article no.	Type	Dim.	Weight kg
299172	Wilo PARA 15-130/8-75/SC-9	F 1" x M 1"	3.7
299174	Taco ES2C 15-70-130	F 1" x M 1"	3.7

LK 861 - Pump Group with direct supply. Without pump

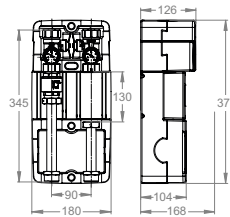

Article no.	Dim.	Weight kg
299842	F 1" x M 1"	1.7

LK 862 R - Pump group with mixed supply - Right version

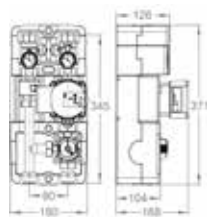

Article no.	Type	Dim.	Kvs m ³ /h	Weight kg
299171	Wilo PARA 15-130/8-75/SC-9	F 1" x M 1"	6.3 / 10.0	4.0
299173	Taco ES2C 15-70-130	F 1" x M 1"	6.3 / 10.0	4.0

LK 862 R - Pump group with mixed supply. Without pump

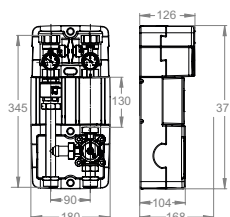

Article no.	Dim.	Kvs m ³ /h	Weight kg
299841	F 1" x M 1"	6.3 / 10.0	2.0

SPARE PARTS AND ACCESSORIES



Article no.	Article	Position
187227	Wilo PARA 15-130/8-75/SC-9	1
187228	Taco ES2C 15-70-130	1
187229	Bracket	2
187230	EPP Insulation	3
187231	Ballvalve, LK 316 F1" / F1"	4
095018	Thermometer T40, 0 - 80 °C	5
182765	LK 850 ThermoMix HG Kvs 6,3/10	6
187190	Repair kit LK 840 DN 15-20	7

Pump groups

LK HydronicGroup C/C 125

- All in one
- Easy to install
- Easy to combine with electronic regulation



TECHNICAL DATA

Voltage	230 VAC 50/60 Hz
Power consumption	10-75 W, depending on pump speed
Max. working pressure	1.0 MPa (10 bar)
Working temperature	Min. 5 °C/Max. 95 °C
Ambient temperature	Min. 5 °C/Max. 58 °C
Thread standard	Rp - female thread, G - male thread
Media	Water - Glycol mixture max. 50%
Circulating pump	Wilo Para 15-130/8-75/SC-9, Wilo Para 25-180/6-43/SC-12, Wilo Para 25-180/8-75/SC-12, Wilo PARA zKu 15-130/8 SC
Material, valve body	Brass EN 12165 CW617N
Material, insulation	Expanded Polypropylene EPP

LK HydronicGroup is a complete pump group that is suitable for heating where direct supply or mixed supply is desirable. Consists of a highly efficient circulation pump, insulation, wall mounting bracket and two ball valves with thermometer, on the return side there is an integrated check valve.

LK 860 manifold available with or without hydraulic separator for one, two, three optionally four pump groups. Wall mounting bracket are included with the manifold.

LK 861 pump group where direct supply is desired.

LK 862 pump group where mixed supply is desired, a three-way mixing valve is included.

LK 860 - Manifold

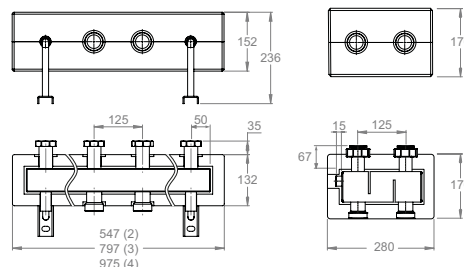

Article no.	Type	Dim.	Note	Weight kg
182419	Manifold, 1 pc groups with hydraulic separator	M 1½"	0.4 MPa (4 bar)	5.0
182348	Manifold, 2 pc groups, without hydraulic separator	M 1½"	0.4 MPa (4 bar)	6.0
182350	Manifold, 2 pc groups with hydraulic separator	M 1½"	0.4 MPa (4 bar)	7.0
182349	Manifold, 3 pc groups, without hydraulic separator	M 1½"	0.4 MPa (4 bar)	8.0
182351	Manifold, 3 pc groups, with hydraulic separator	M 1½"	0.4 MPa (4 bar)	9.0
182417	Manifold, 4 pc groups, without hydraulic separator	M 1½"	0.4 MPa (4 bar)	9.0
182418	Manifold, 4 pc groups, with hydraulic separator	M 1½"	0.4 MPa (4 bar)	10.0

LK 863 pump group where mixed supply is desired, a thermic mixing valve is included. The LK 551 HydroMix has a thermostatic element that regulates the supply and return to achieve the desired supply temperature.

LK 864 pump group with a thermic loading valve LK 823 ThermoVar®. The pump group is intended to ensure both an optimal temperature stratification in the storage tank and high return temperature to the boiler, thus increasing the efficiency of the system.

LK 865 is a complete unit for hot water circulation. Consists of a mixing valve, cross, circulation pump, insulation, connection kit and three check valves. The LK 551 HydroMix mixing valve has a thermostatic element that regulates the supply of both cold and hot water to the desired temperature. The valve has an anti-scald function that closes for incoming hot water if the cold water supply ceases.

LK 866 is a pump group with a four way mixing valve, LK 841 ThermoMix®. The pumpgroup is designed for heating systems where a high return temperature is required to prevent corrosion and thus extend the life length of the heat source.

LK 867 is a pump group with a four way mixing valve, LK 830 ThermoMix® B. The pump group has a 4-way bivalent mixing valve that is designed for heating systems, where energy is taken from two heating units connected in series or parallel or for storage tank systems where energy is extracted from two levels. The pump group should be equipped with an automatic control unit to ensure that the most favourable heat source is prioritised at all times.

LK 861 - PUMP CHARACTERISTICS

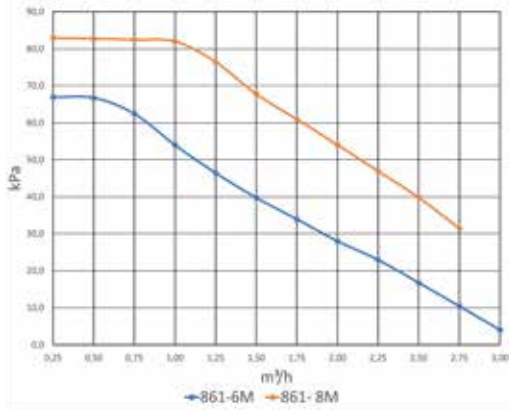

LK 861 - PUMP GROUP WITH DIRECT SUPPLY

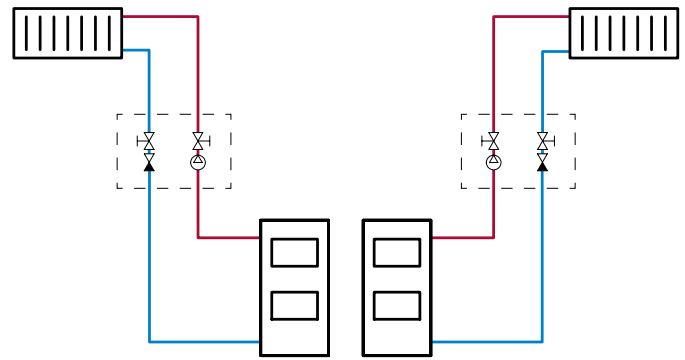

LK 861 - Pump group with direct supply

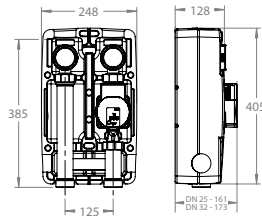

Article no.	Dim.	DN	Weight kg
299458	M 1½" / F 1" x M 1½"	DN 25	5.0
299459	M 1½" / F 1" x M 1½"	DN 32	5.2

LK 861 - Pump group with direct supply. Whitout pump

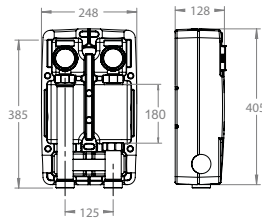

Article no.	Dim.	Weight kg
299460	M 1½" / F 1" x M 1½"	3.1

LK 862 - PUMP CHARACTERISTICS

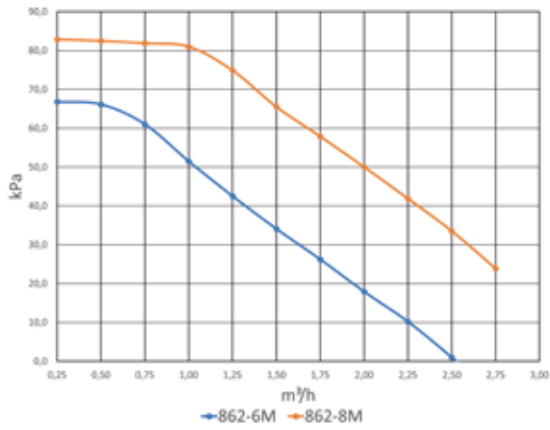

LK 862 - PUMP GROUP WITH MIXING VALVE

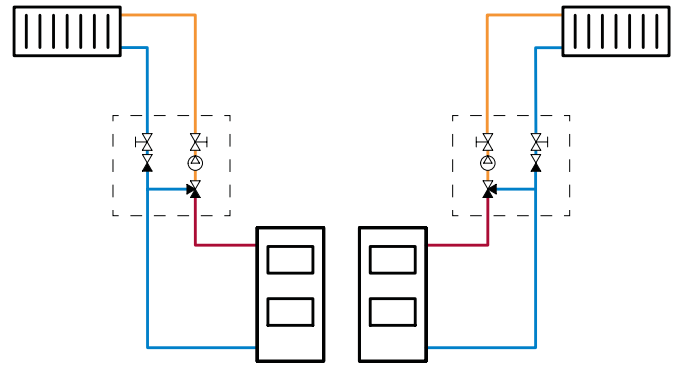

LK 862 R - Pump group with mixed supply - Right version

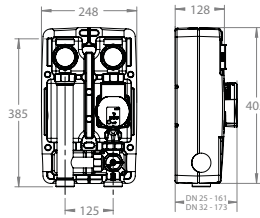

Article no.	Dim.	DN	Kvs m³/h	Weight kg
299462	M 1½" / F 1" x M 1½"	DN 25	6.3	5.3
299464	M 1½" / F 1" x M 1½"	DN 32	10.0	5.5

LK 862 L - Pump group with mixed supply - Left version

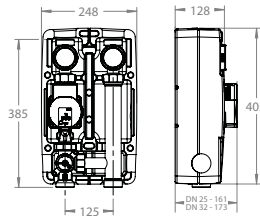

Article no.	Dim.	DN	Kvs m³/h	Weight kg
299461	M 1½" / F 1" x M 1½"	DN 25	6.3	5.3
299463	M 1½" / F 1" x M 1½"	DN 32	10.0	5.5

LK 862 - Pump group with mixed supply. Whitout pump

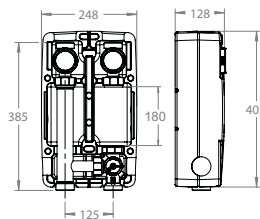

Article no.	Dim.	Kvs m³/h	Weight kg
299465	M 1½" / F 1" x M 1½"	6.3	3.1
299466	M 1½" / F 1" x M 1½"	10.0	3.1

LK 863 - PUMP CHARACTERISTICS

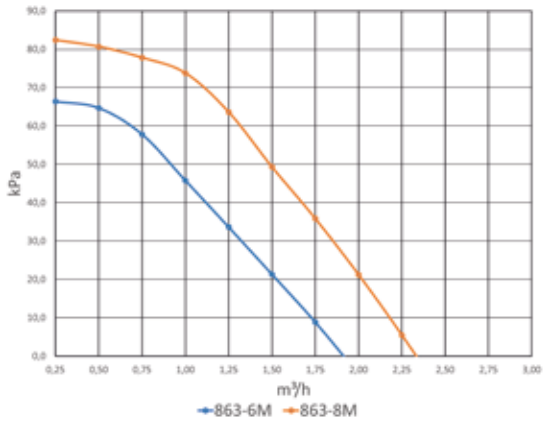

LK 863 - PUMP GROUP WITH MIXING VALVE

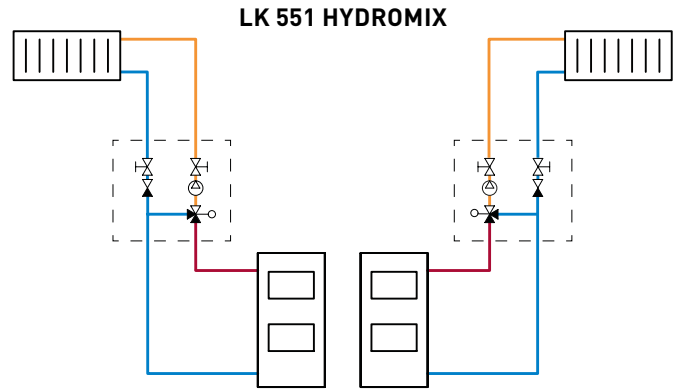

LK 863 - Pump group with thermic mixing valve

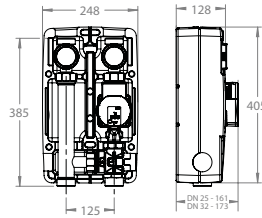

Article no.	Dim.	DN	Note	Weight kg
299467	M 1½" / F 1" x M 1½"	DN 25	Temperature: 25 - 45 °C	5.8
299468	M 1½" / F 1" x M 1½"	DN 32	Temperature: 25 - 45 °C	6.0

LK 863 - Pump group with thermic mixing valve. Without pump

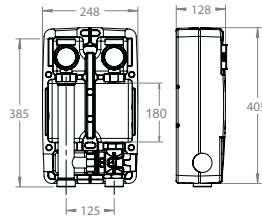

Article no.	Dim.	Note	Weight kg
299469	M 1½" / F 1" x M 1½"	Temperature: 25 - 45 °C	4.0

LK 864 - PUMP CHARACTERISTICS

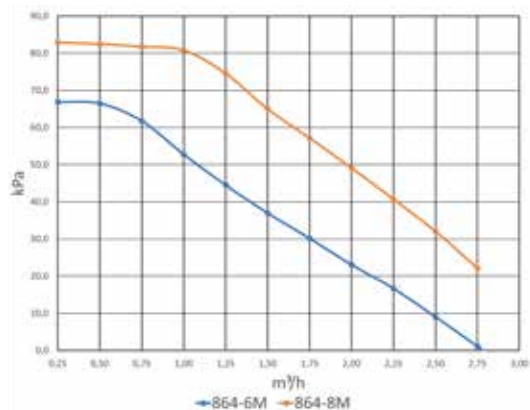

LK 864 - PUMP GROUP WITH THERMIC LOADING VALVE

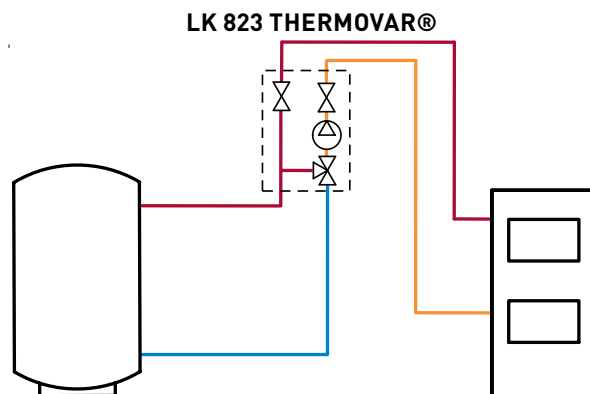

LK 864 - Pump group with thermic loading valve, LK 823 ThermoVar®

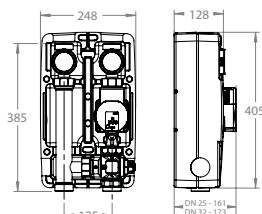

Article no.	Dim.	DN	Kvs m ³ /h	Note	Weight kg
299470	M 1½" / F 1" x M 1½"	DN 25	9.0	Opening temperature: 55 - 70 °C	5.7
299471	M 1½" / F 1" x M 1½"	DN 32	9.0	Opening temperature: 55 - 70 °C	5.9
299787	M 1½" / F 1" x M 1½"	DN 25	9.0	Opening temperature: 45 - 60 °C	5.7
299788	M 1½" / F 1" x M 1½"	DN 32	9.0	Opening temperature: 45 - 60 °C	5.9

LK 864 - Pump group with thermic loading valve, LK 823 ThermoVar®. Without pump

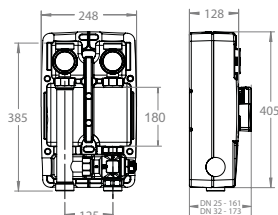

Article no.	Dim.	DN	Kvs m ³ /h	Note	Weight kg
299962	M 1½" / F 1" x M 1½"	DN 25	9.0	Opening temperature: 55 - 70 °C	3.5

LK 865 - PUMP CHARACTERISTICS

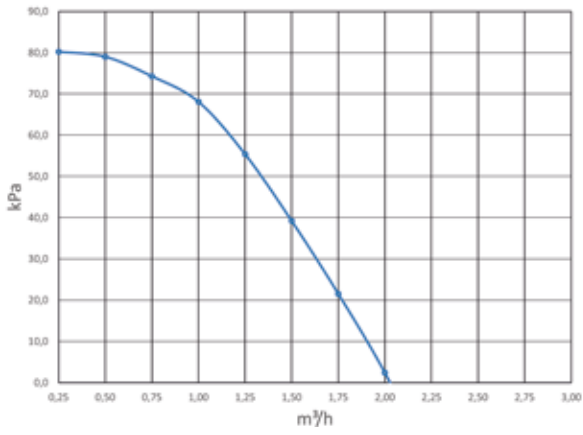

LK 865 - COMPLETE UNIT FOR HOT WATER CIRCULATION

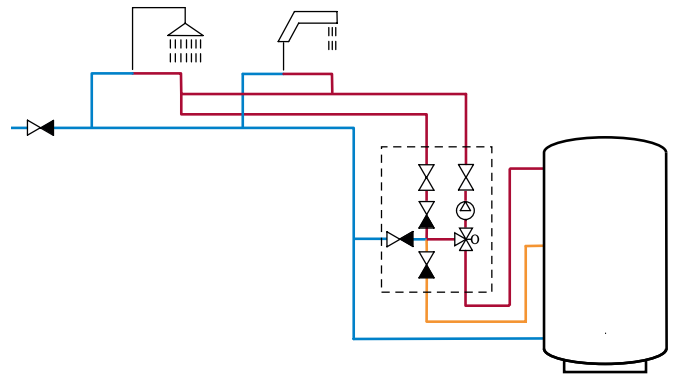

LK 865 - Complete unit for hot water circulation

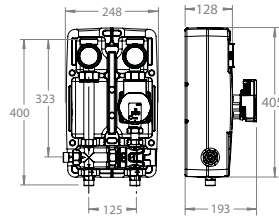

Article no.	Dim.	Note	Weight kg
299472	F 1" x M 1"	Opening temperature: 35 - 65 °C	4.9

LK 865 - Complete unit for hot water circulation. Without pump

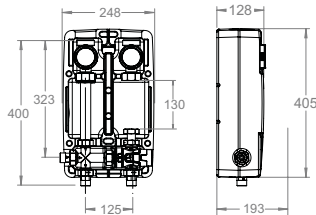

Article no.	Dim.	Note	Weight kg
299963	F 1" x M 1"	Opening temperature: 35 - 65 °C	2.7

LK 866 - PUMP CHARACTERISTICS

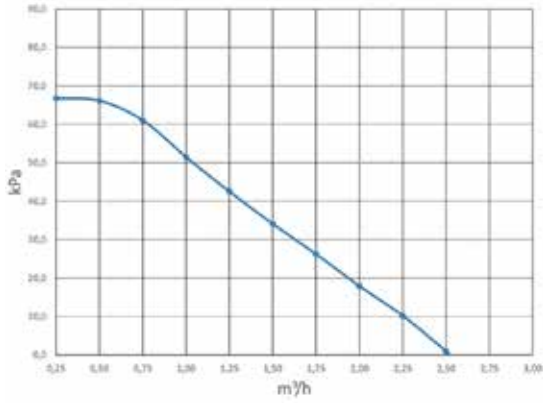

LK 866 - PUMP GROUP WITH A FOUR WAY MIXING VALVE, LK 841 THERMOMIX®

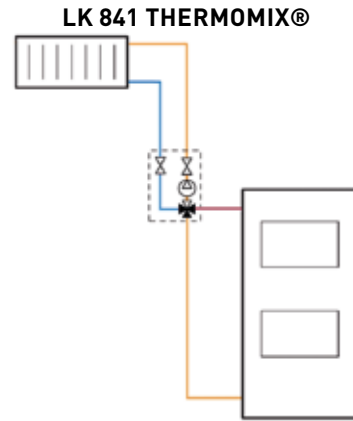

LK 866 - Pump group with a four way mixing valve, LK 841 ThermoMix®

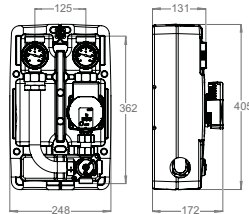

Article no.	Dim.	DN	Kvs m³/h	Weight kg
299747	M 1½" / F 1" x M 1"	DN 25	6.3	5.3

LK 866 - Pump group with a four way mixing valve, LK 841 ThermoMix®. Without pump

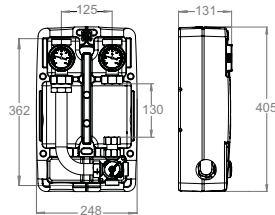

Article no.	Dim.	DN	Kvs m³/h	Weight kg
299964	M 1½" / F 1" x M 1"	DN 25	6.3	3.1

LK 866 - PUMP CHARACTERISTICS

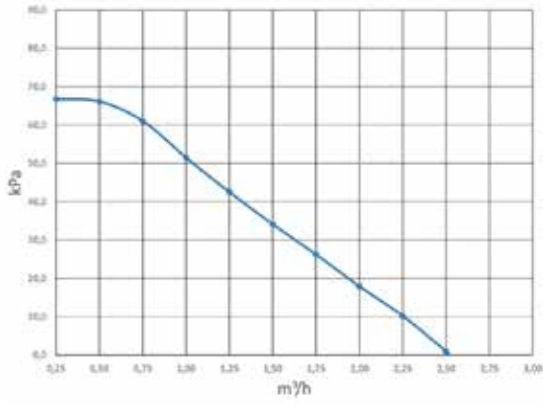

LK 867 - PUMP GROUP WITH A FOUR WAY MIXING VALVE, LK 830 THERMOMIX® B

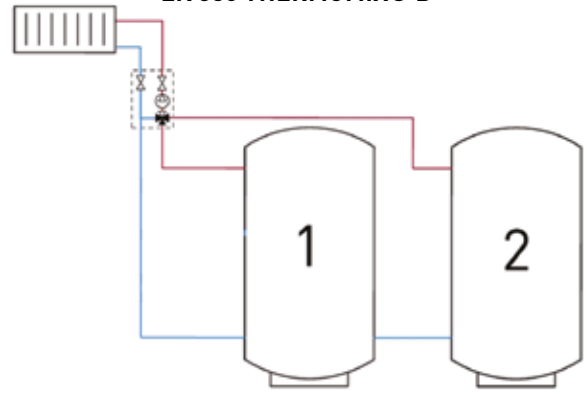

LK 867 - Pump group with a four way mixing valve, LK 830 ThermoMix® B

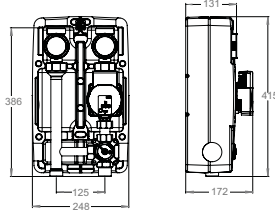

Article no.	Dim.	DN	Kvs m³/h	Weight kg
299765	M 1½" / F 1" x M 1"	DN 25	6.3	5.3

LK 867 - Pump group with a four way mixing valve, LK 830 ThermoMix® B. Without pump

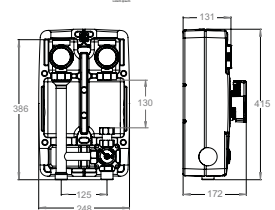

Article no.	Dim.	DN	Kvs m³/h	Weight kg
299965	M 1½" / F 1" x M 1"	DN 25	6.3	3.1

SPARE PARTS AND ACCESSORIES

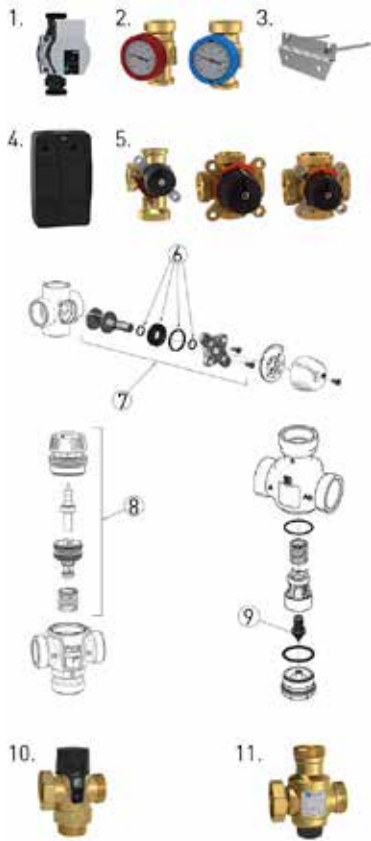

Article no.	Article	Position
187203	Wilo PARA 25-180/8-75/SC	1
187322	Wilo PARA 25-180/6-43/SC	1
187227	Wilo PARA 15-130/8-75/SC-9	1
187323	Ballvalve, blue	2
187324	Ballvalve, red	2
187325	Bracket	3
187326	EPP Insulation	4
182766	LK 840 ThermoMix HG Kvs 6,3	5
182767	LK 840 ThermoMix HG Kvs 10	5
181949	LK 840 Mixing Valve (866), Kvs 6.3	5
180588	LK 830 Mixing Valve (867), (Kvs 6.3)	5
187188	Sealing kit LK 840/841 DN 25	6
187191	Repair kit LK 840 DN 25	7
187195	Repair kit 841 2.0, DN 25	7
187062	Repair kit 830, DN 15-20, Kvs 6.3	7
095349	Repair kit 551, 25 - 45 °C (Kvs 3.2-4.2)	8
095350	Repair kit 551, 35 - 65 °C (Kvs 3.2-4.2)	8
187330	Repair Kit 823R	9
182431	LK 551 (863), 25 - 45 °C	10
182389	LK 823R (864), 55 - 70 °C	11
182447	LK 823R (864), 45 - 60 °C	11

Tap Water Units

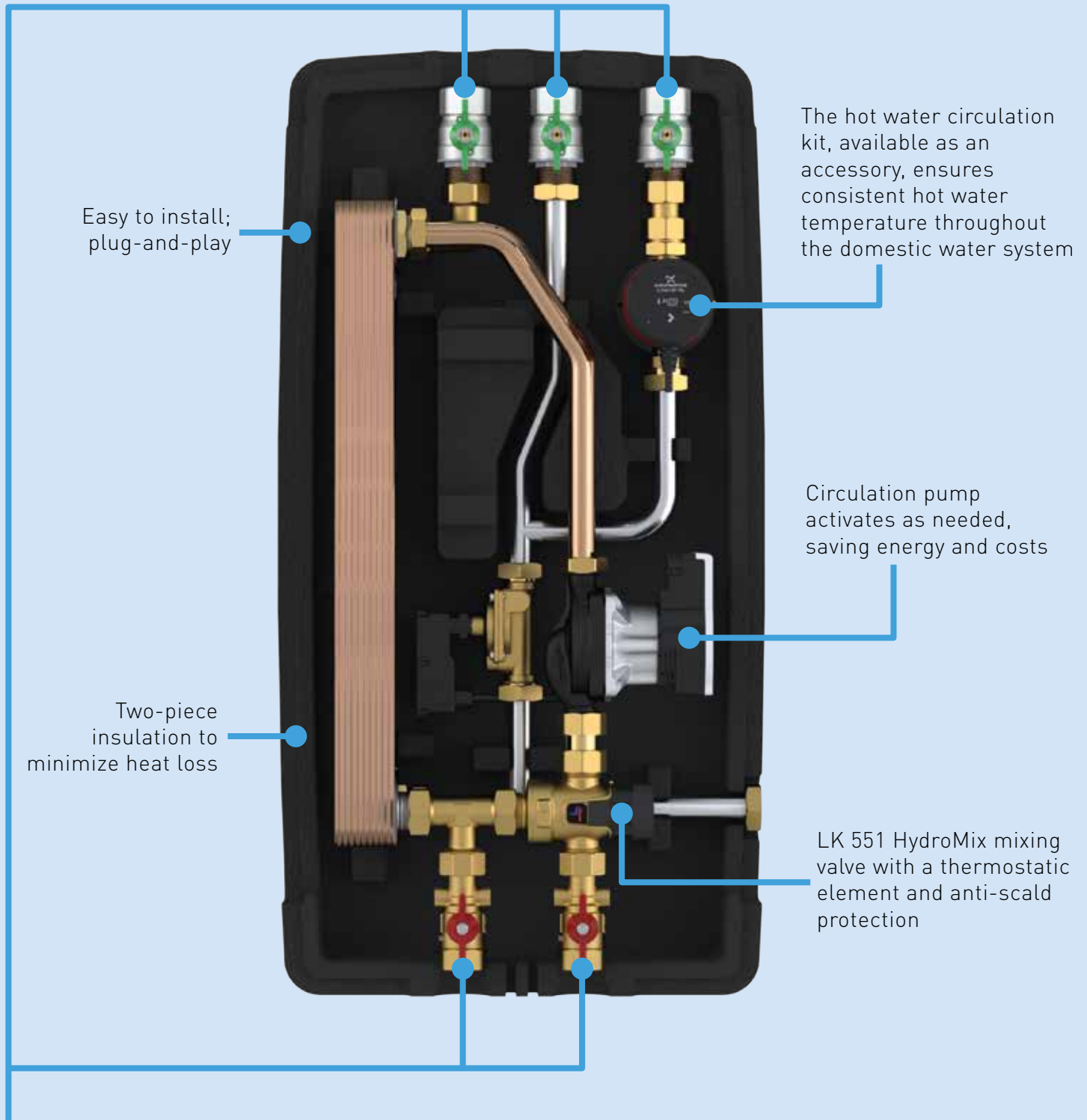

Easy to install; plug-and-play

The hot water circulation kit, available as an accessory, ensures consistent hot water temperature throughout the domestic water system

Circulation pump activates as needed, saving energy and costs

Two-piece insulation to minimize heat loss

LK 551 HydroMix mixing valve with a thermostatic element and anti-scald protection

Valves with 1" internal threads

LK 250 TapWater Unit delivers hot water with precision. Whether you choose the electronic controller or the thermic mixing valve model, both options ensure reliable temperature control. The circulation pump is only active when hot water is required, which reduces energy consumption. A hot water circulation kit is available to maintain a consistent temperature throughout the house.

Tap Water Units

LK 250 TapWater Unit

- Easy to install - Plug-and-Play
- Scald protection with LK 551 HydroMix
- Available with anti-limestone coated heat exchanger.



TECHNICAL DATA

Voltage	230 VAC 50/60 Hz
Power consumption	10-75 W, depending on pump speed
Max. working pressure	1,0 MPa (10 bar)
Working temperature	Min. 5 °C/Max. 95 °C
Ambient temperature	Min. 5 °C/Max. 55 °C
Thread standard	G - female thread
Media	Water - Glycol mixture max. 50%
Circulating pump	Wilo Para IPWM1 15-130/8 Wilo Para 15-130/8-75/SC-9
Material, insulation	Expanded Polypropylene EPP

CAPACITY

Hot water primary °C	Tap water temp. °C	Tap water capacity l/min.	Hot water return °C	Performance kW
60	45	20	25	51
70	45	22	24	58
80	45	25	21	64
65	45	42	19	90
75	60	30	25	90

The LK 250 TapWater Unit is a device for heating tap water.

LK 250 TapWater Unit P has an electronic controller unit that regulates the desired tap water temperature and at the same time regulates the inlet temperature to the plate heat exchanger to protect it from limestone.

The LK 250 TapWater Unit P consists of a plate heat exchanger, circulation pump, flow sensor, safety valve and an electronic controller.

The temperature of the tap water can be adjusted between 40 and 65 °C. The circulation pump only runs when hot water is required, which reduces energy consumption.

LK 250 TapWater Unit

Unlike the LK 250 TapWater Unit P, this unit has a thermic mixing valve which, instead of an electronic controller, regulates the tap water temperature and at the same time regulates the inlet temperature to the plate heat exchanger to protect it from limescale deposits.

The LK 250 TapWater Unit consists of a plate heat exchanger, circulation pump, flow sensor, safety valve and a mixing valve.

The temperature of the tap water can be adjusted between 35 and 65°C. The circulation pump only runs when tap water is needed, which reduces energy consumption.

When choosing a tap water unit, it is important to know the water quality in the area where the unit will be installed.

A hot water circulation kit is available as an accessory used to maintain the intended hot water temperature in the entire domestic hot water system, which is particularly suitable in buildings where a tap point is located some distance away.

PRESSURE DROP DIAGRAM - LK 250 M

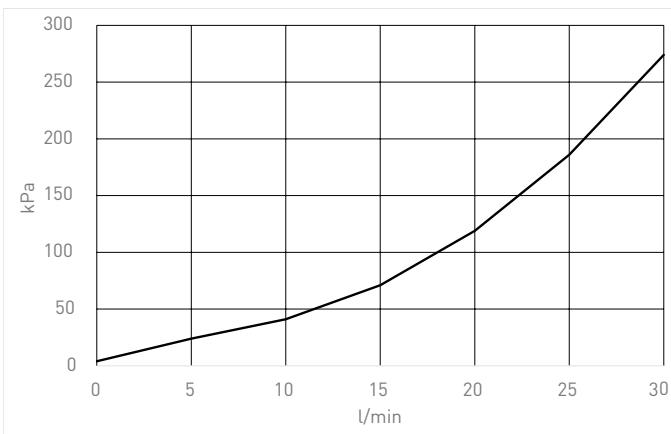

PRESSURE DROP DIAGRAM - LK 250 P

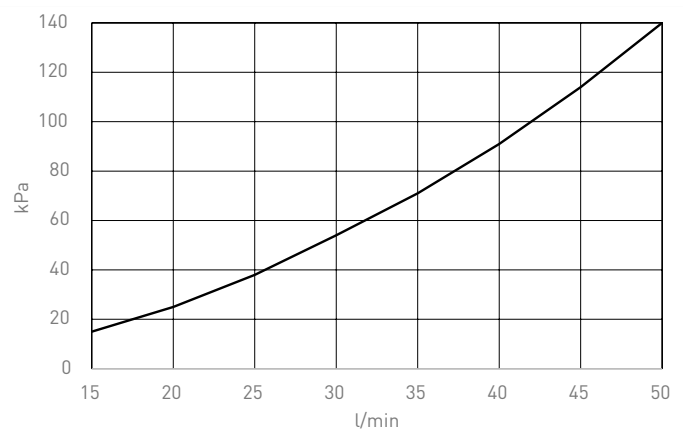

LK 250 TAPWATER UNIT P - WITH CONTROLLER

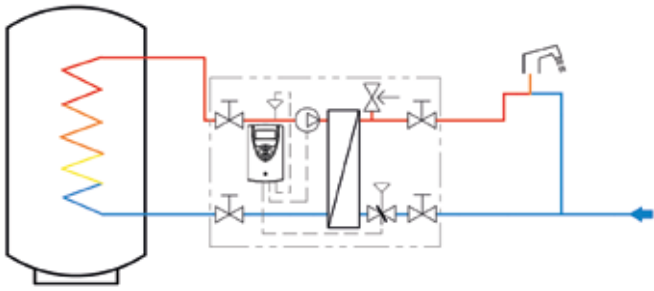

LK 250 TAPWATER UNIT - WITHOUT CONTROLLER

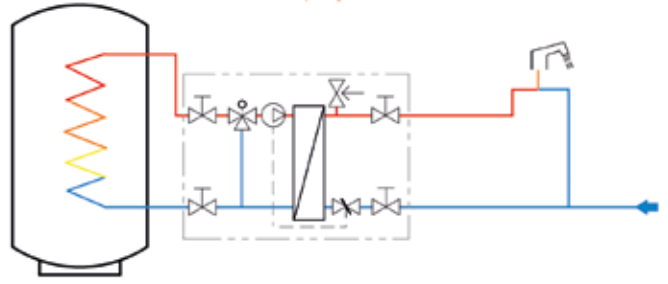

LK 250 TAPWATER UNIT P - WITH CONTROLLER AND HOT WATER CIRCULATION

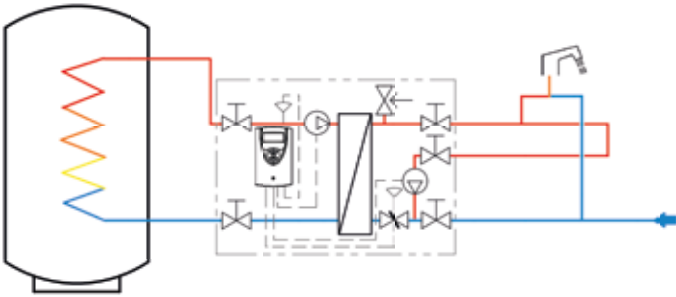

LK 250 TAPWATER UNIT - WITHOUT CONTROLLER WITH HOT WATER CIRCULATION

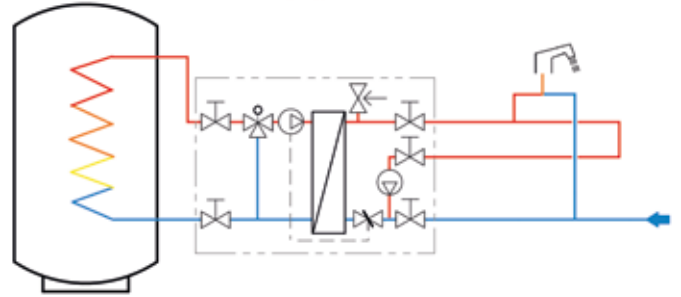

LK 250 P - Female thread

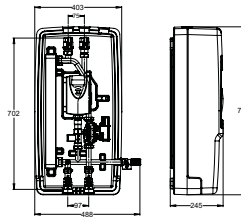

Article no.	Dim.	Weight kg
396003	F 1"	12.4

LK 250 P - Female thread - with anti-limestone coated heat exchanger

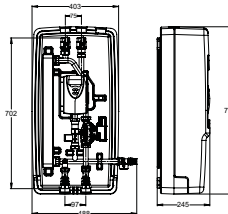

Article no.	Dim.	Note	Weight kg
396008	F 1"	With anti-limestone coated heat exchanger	12.4

LLK 250 - Female thread - without controller

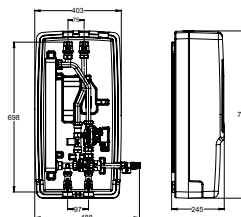

Article no.	Dim.	Note	Weight kg
396001	F 1"	Without controller	12.0

LK 250 - Female thread - without pump and controller

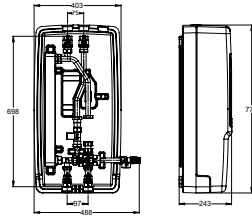

Article no.	Dim.	Note	Weight kg
396002	F 1"	Without pump and controller	11.0

LK 250 - Female thread - without controller, with anti-limestone coated heat exchanger

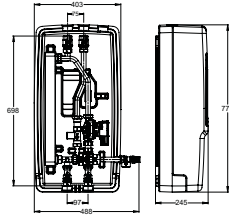

Article no.	Dim.	Note	Weight kg
396006	F 1"	Without controller, with anti-limestone coated heat exchanger	12.0

LK 250 - Female - without pump and controller, with anti-limestone coated heat exchanger

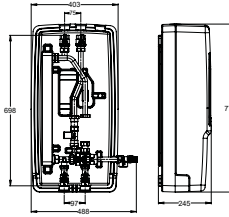

Article no.	Dim.	Note	Weight kg
396007	F 1"	Without pump and controller, with anti-limestone coated heat exchanger	11.0

SPARE PARTS AND ACCESSORIES



Article no.	Article	Position
092360	Hot water circulation kit	1
182742	Controller, LK TapWater	2
095472	Wilo Para IPWM1 15-130/8	3
187227	Wilo Para 15-130/8-75/SC-9	4
095476	EPP Insulation	5
095480	Flow sensor P	6
095481	Flow sensor	7
182199	LK 551 HydroMix	8

Solar Pump Units

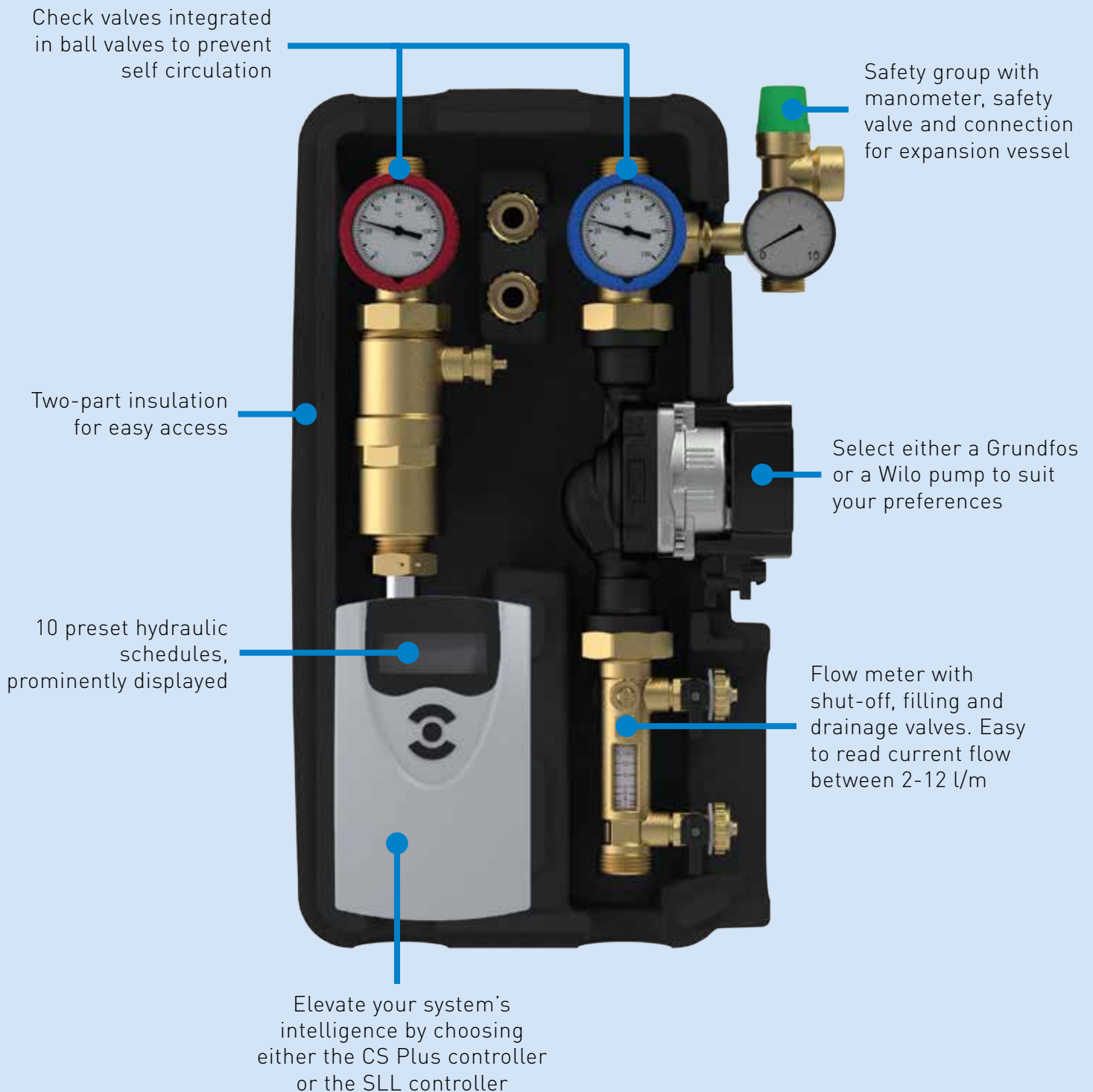

LK 212 SolarStation is your compact, dual-pipe solar pump unit, available with or without a controller. It's the complete package, equipped with all the essential components for ensuring the safe and efficient operation of your solar heating system.

Solar Pump Units

LK 211 SolarStation

- Reduced energy costs by using solar power
- Compact single-pipe solar unit
- Connections with 3/4" female thread and 1" male thread



TECHNICAL DATA

Voltage	230 VAC ± 10%, 50 Hz
Max. working pressure	1,0 MPa (10 bar)
Operating pressure	0,6 MPa (6 bar)
Working temperature	Max. 110 °C
Thread standard	G - male thread, G - female thread
Protection type	IP 20
Media	Water - Glycol mixture max. 50%
Sensors	PT 1000
Circulating pump	Grundfos UPM3 Solar 25-75 130 Wilo Para ST 25-130/8 IPWM2

LK 211 SolarStation is a compact single-pipe solar pump unit. It contains all the necessary components for a safe operation and control of the solar heating system such as safety group, circulating pump, ball valve with integrated check valve and thermometer, flow meter with shut-off, filling and drainage valves.

Option of selecting between two different controllers, LK 152 SmartSolar SLL or LK 152 SmartSolar CS Plus. A variant without a controller and/or circulation pump is also optional if you wish to supply it yourself.

LK 152 SmartSolar SLL and SC Plus has both 10 preset hydraulic schedules. The chosen hydraulic schedule and operating status is shown on the display.

LK 211 SOLARSTATION WITH LK 152 SMARTSOLAR SLL

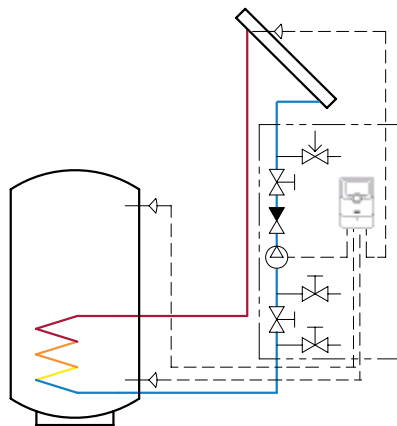

LK 211 SOLARSTATION WITH LK 152 SMARTSOLAR CS PLUS

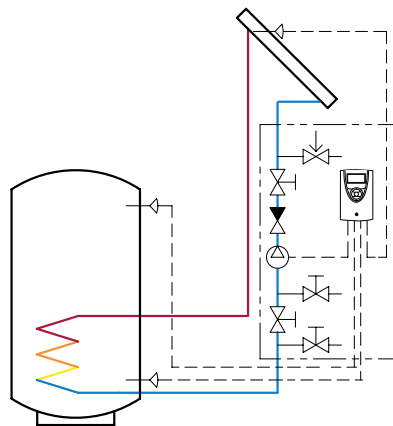

LK 211 SOLARSTATION WITHOUT CONTROLLER

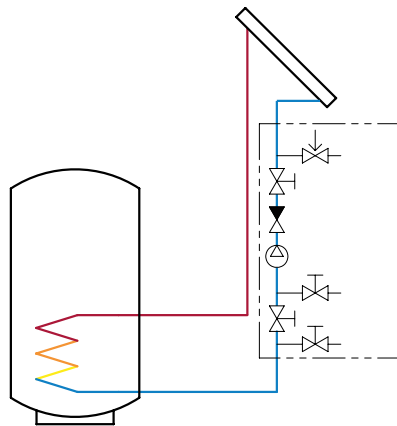

LK 211 - Female / male thread - without pump and controller

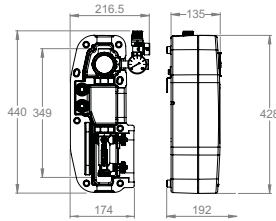

Article no.	Dim.	Flow range	Note	Weight kg
396198	F 3/4" / M 1"	2-12 l/min.	Without pump and controller	1.8

LK 211 - Female / male thread - without controller

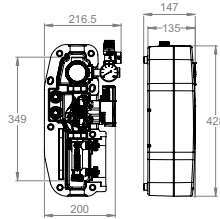

Article no.	Dim.	Flow range	Note	Weight kg
396192	F 3/4" / M 1"	2-12 l/min.	With Wilo pump, without controller	3.6
396195	F 3/4" / M 1"	2-12 l/min.	With Grundfos pump, without controller	3.6

LK 211 - Female / male thread - with LK 152 SmartSolar SLL

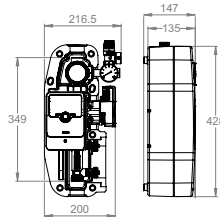

Article no.	Dim.	Flow range	Note	Weight kg
396193	F 3/4" / M 1"	2-12 l/min.	With LK 152 SmartSolar SLL, Wilo pump	4.0
396196	F 3/4" / M 1"	2-12 l/min.	With LK 152 SmartSolar SLL, Grundfos pump	4.0

LK 211 - Female / male thread - with LK 152 SmartSolar CS Plus

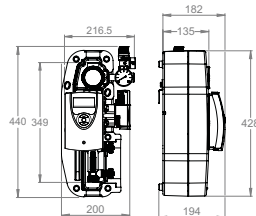

Article no.	Dim.	Flow range	Note	Weight kg
396194	F 3/4" x M 1"	2-12 l/min.	With LK 152 SmartSolar CS Plus, Wilo pump	4.0
396197	F 3/4" x M 1"	2-12 l/min.	With LK 152 SmartSolar CS Plus, Grundfos pump	4.0

LK 152 SMARTSOLAR SLL

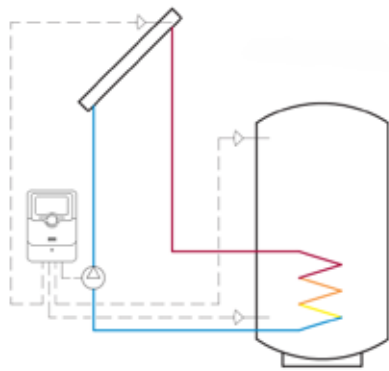

LK 152 SMARTSOLAR CS PLUS

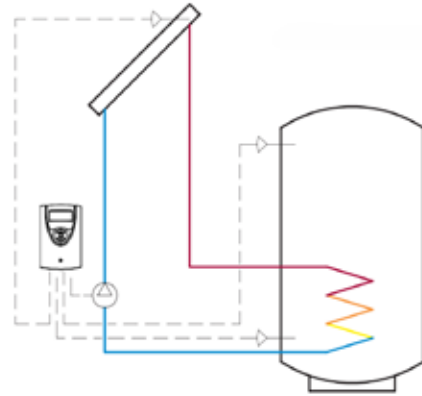

SPARE PARTS AND ACCESSORIES



Artikelnr.

182675
182735
187961
095494
095495
095474
095496
095478
095479

Artikel

LK 152 SmartSolar SLL
LK 152 SmartSolar CS Plus
Bracket
Grundfos UPM3 Solar
Wilo Para ST IPWM2
Ballvalve blue
EPP Insulation
Safety group
Filling valve

Position

1
2
3
4
5
6
7
8
9

Solar Pump Units

LK 212 SolarStation

- Reduced energy costs by using solar power
- Compact dual-pipe solar unit
- Connections with 3/4" female thread and 1" male thread



TECHNICAL DATA

Voltage	230 VAC ± 10%, 50 Hz
Max. working pressure	1,0 MPa (10 bar)
Operating pressure	0,6 MPa (6 bar)
Working temperature	Supply: Max. 140 °C Return: Max. 110 °C
Thread standard	G - male thread, G - female thread
Protection type	IP 20
Media	Water - Glycol mixture max. 50%
Sensors	PT 1000
Circulating pump	Grundfos UPM3 Solar 25-75 180, Wilo Para ST 25-180/8 IPWM2

LK 212 SolarStation is a compact dual-pipe solar pump unit. It contains all the necessary components for a safe operation and control of the solar heating system such as safety group, circulating pump, ball valve with integrated check valve and thermometer, air separator with manual air vent, flow meter with shut-off, filling and drainage valves.

Option of selecting between two different controllers, LK 152 SmartSolar SLL or LK 152 SmartSolar CS Plus. A variant without a controller and/or circulation pump is also optional if you wish to supply it yourself.

LK 152 SmartSolar SLL and SC Plus has both 10 preset hydraulic schedules. The chosen hydraulic schedule and operating status is shown on the display.

LK 212 SOLARSTATION WITH LK 152 SMARTSOLAR SLL

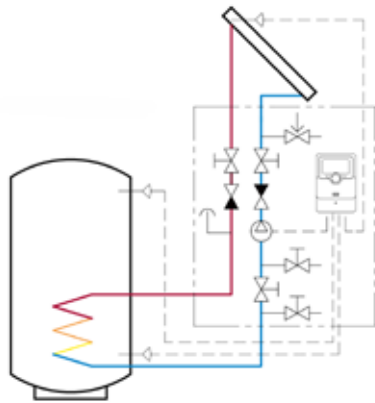

LK 212 SOLARSTATION WITH LK 152 SMARTSOLAR CS PLUS

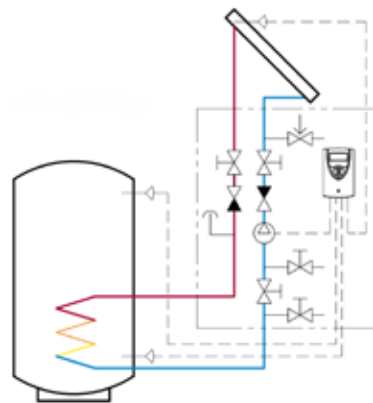

LK 212 SOLARSTATION WITHOUT CONTROLLER

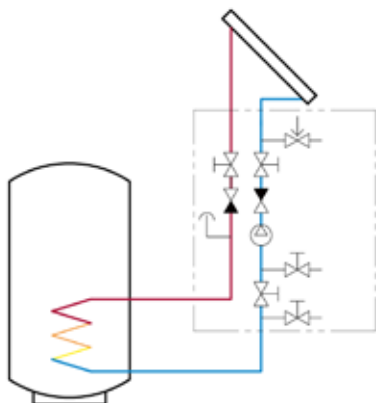

LK 212 - Female / male thread - without pump and controller

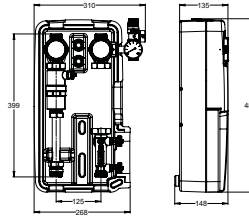

Article no.	Dim.	Flow range	Note	Weight kg
299999	F 3/4" / M 1"	2-12 l/min.	Without pump and controller	3.6

LK 212 - Female / male thread - without controller

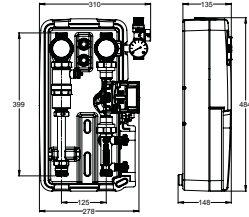

Article no.	Dim.	Flow range	Note	Weight kg
299998	F 3/4" / M 1"	2-12 l/min.	With Grundfos pump, without controller	5.6
396039	F 3/4" / M 1"	2-12 l/min.	With Wilo pump, without controller	5.6

LK 212 - Female / male thread - with LK 152 SmartSolar SLL

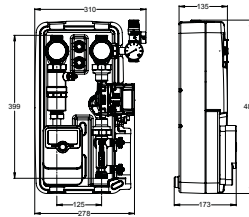

Article no.	Dim.	Flow range	Note	Weight kg
396000	F 3/4" / M 1"	2-12 l/min.	With LK 152 SmartSolar SLL, Grundfos pump	6.0
396040	F 3/4" / M 1"	2-12 l/min.	With LK 152 SmartSolar SLL, Wilo pump	6.0

LK 212 - Female / male thread - with LK 152 SmartSolar CS Plus

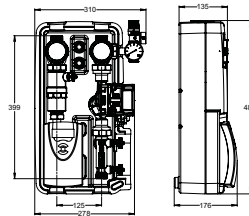

Article no.	Dim.	Flow range	Note	Weight kg
396050	F 3/4" x M 1"	2-12 l/min.	With LK 152 SmartSolar CS Plus, Wilo pump	6.0
396051	F 3/4" / M 1"	2-12 l/min.	With LK 152 SmartSolar CS Plus, Grundfos pump	6.0

LK 152 SMARTSOLAR CS PLUS

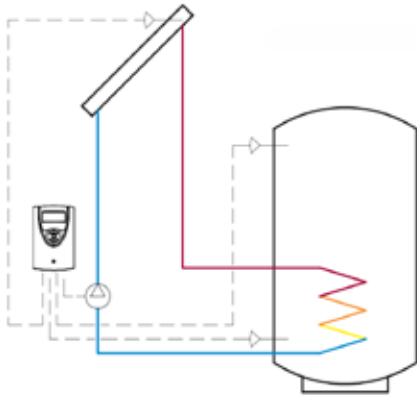

LK 152 SMARTSOLAR SLL

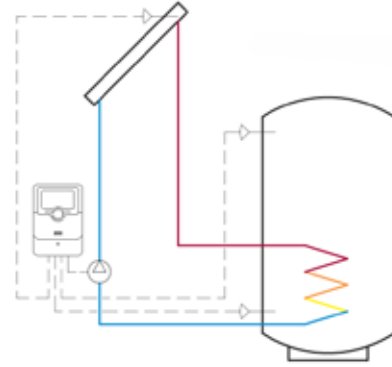

SPARE PARTS AND ACCESSORIES



Article no.	Article	Position
182675	LK 152 SmartSolar SLL	1
182735	LK 152 SmartSolar CS Plus	2
187325	Bracket	3
095470	Grundfos UPM3 Solar	4
095471	Wilo Para ST IPWM2	5
095473	Ballvalve, red	6
095474	Ballvalve, blue	7
095475	EPP Insulation	8
095477	Air vent	9
095478	Safety group	10
095479	Filling valve	11



Follow us on social media

Keep up to date with all the news from LK Armatur. We'll pass on all the latest news, upcoming events, job vacancies and much more.

So follow us to keep up to date with what we're doing!



Facebook



Instagram



LinkedIn



YouTube

Thermic Valves and Check Valves

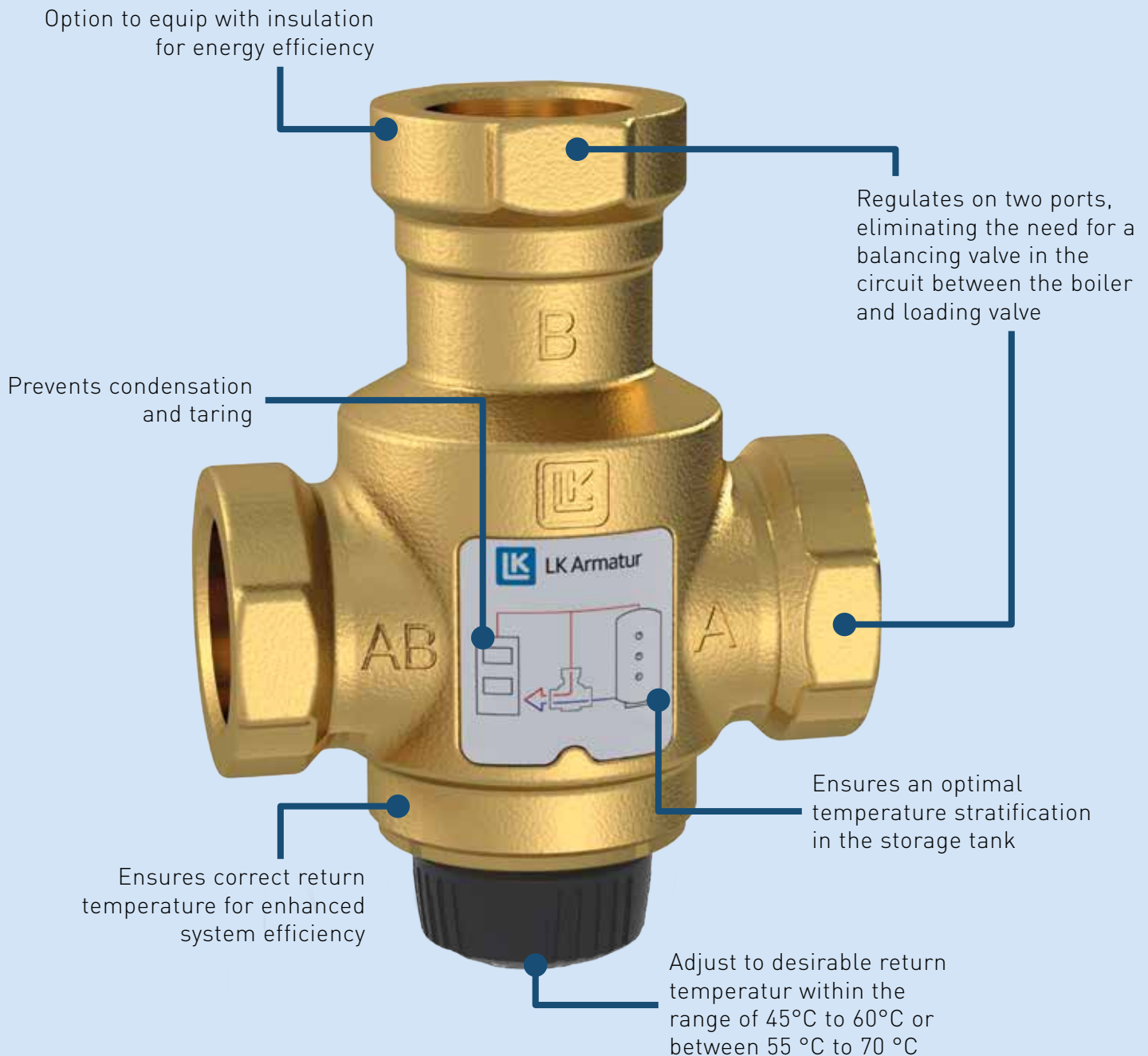

Improve your heating system with **LK 823 ThermoVar® R**, a 3-way thermic loading valve. It ensures optimal temperature distribution in your storage tank, enhances boiler efficiency, and prevents tarring and condensation. With the possibility to adjust the return temperature within the range of 45 °C to 60 °C or between 55 °C to 70 °C, it's the perfect valve for your system.

Thermic Loading Valve

LK 820 ThermoVar®



- Position-independent



TECHNICAL DATA

Max. working pressure	1.0 MPa (10 bar)
Max. differential pressure	50 kPa (0,5 bar)
Working temperature	(45 - 55 °C) Min. 5 °C/Max. 95 °C (61 - 80 °C) Min. 5 °C/Max. 110 °C
Opening temperature	45 °C, 55 °C, 61 °C, 66 °C, 72 °C or 80 °C
Ambient temperature	Min. 5 °C/Max. 60 °C
Thread standard	Rp - female thread, G - male thread
Media	Water - Glycol mixture max. 50%
Material, valve body	Brass EN 12165 CW617N
Material, external cover	Brass EN 12165 CW617N M 2" - Coated Aluminium
Material, sealing	EPDM

LK 820 ThermoVar® is a 3-way thermic loading valve for solid fuel/storage tank installations. The valve is intended to ensure both an optimal temperature stratification in the storage tank and a high return temperature to the boiler, thus increasing the efficiency of the system. Tarring and condensation are prevented which prolongs boiler life.

LK 820 can be equipped with an insulation - see under Accessories. For more information, please see the product sheet for insulations.

The valve can be mounted at any angle. LK 820 ThermoVar® can easily be adapted for right- or left-hand mounting. The valve can be installed in three different positions.

In the standard version the valve is intended for installation in position II. It can easily be adapted for installation in position I. For delivery of valves intended for installation in position III, please contact our Sales Department.

POSITION I

As soon as the boiler temperature has reached the selected opening temperature, the thermic valve allows hot water to load to the storage tank. Return water from the storage tank is mixed with supply water before it circulates back into the boiler. The loading temperature is at least the selected opening temperature.

A balancing valve should be installed in the circuit between boiler and loading valve.

The installation should be equipped with an LK 822 ThermoBac check valve to prevent self-circulation from storage tank to boiler after the fire has gone out. In case of power failure or pump breakdown the check valve automatically opens for self-circulation.

The circulating pump should be controlled by a thermostat that measures the boiler's water or flue gas temperature.

POSITION II

As soon as the boiler temperature has reached the selected opening temperature, the thermic valve allows return water from the storage tank to mix with supply water before it circulates back into the boiler. The return temperature is at least the selected opening temperature.

A balancing valve should be installed in the circuit between boiler and loading valve.

The circulating pump should be controlled by a thermostat that measures the boiler's water or flue gas temperature.

POSITION III

As soon as the boiler temperature has reached the selected opening temperature, the thermic valve allows return water from the storage tank to mix with supply water before it circulates back into the boiler. The return temperature is at least the selected opening temperature.

A balancing valve should be installed in the circuit between boiler and loading valve.

The installation should be equipped with an LK 822 ThermoBac check valve to prevent self-circulation from storage tank to boiler after the fire has gone out. In case of power failure or pump breakdown the check valve opens automatically for self-circulation.

The circulating pump should be controlled by a thermostat that measures the boiler's water or flue gas temperature.

CAPACITY DIAGRAM

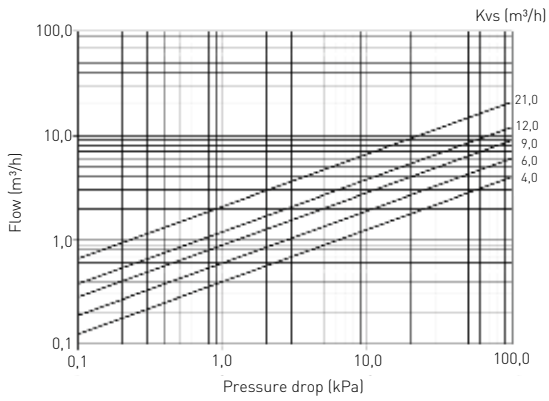

POSITION I

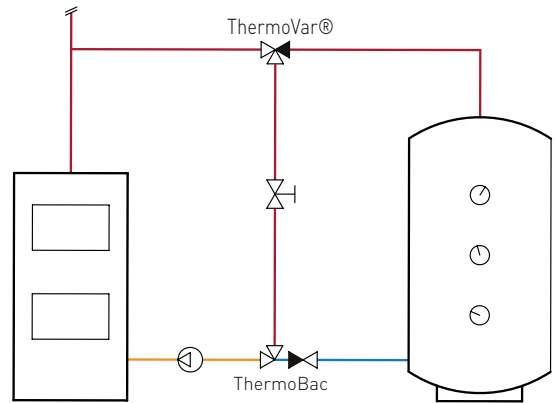

POSITION II

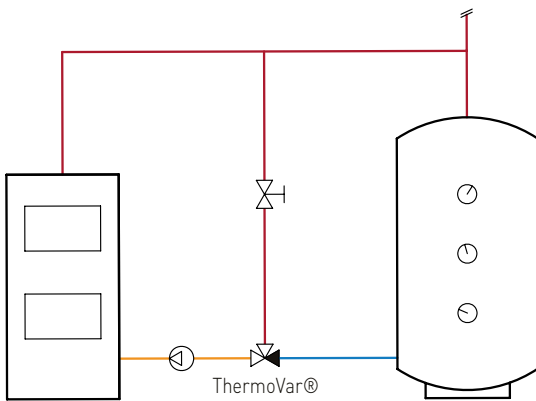

POSITION III

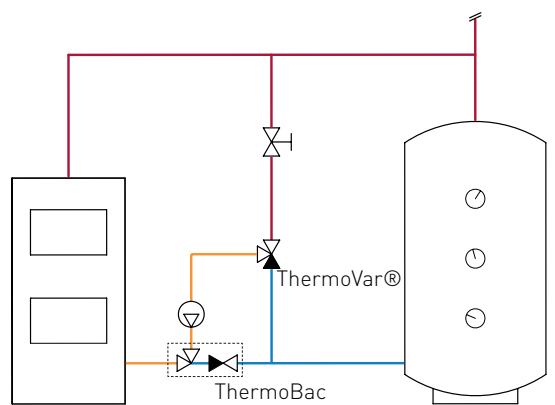

LK 820 - Female thread

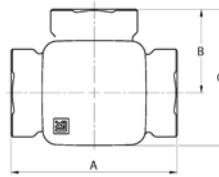
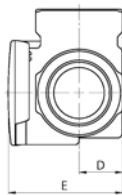

Article no.	Opening temp.	Dim.	Kvs m³/h	A mm	B mm	C mm	D mm	E mm	Weight kg
180493	45 °C	F 1"	9.0	82	41	67	21	35	0.7
180500	55 °C	F ¾"	6.0	80	40	66	21	35	0.7
180501	55 °C	F 1"	9.0	82	41	67	21	35	0.7
180502	55 °C	F 1¼"	12.0	84	42	68	24	39	0.8
180508	61 °C	F ¾"	6.0	80	40	66	21	35	0.7
180509	61 °C	F 1"	9.0	82	41	67	21	35	0.7
180510	61 °C	F 1¼"	12.0	84	42	68	24	39	0.8
180517	66 °C	F 1"	9.0	82	41	67	21	35	0.7
180525	72 °C	F 1"	9.0	82	41	67	21	35	0.7
180526	72 °C	F 1¼"	12.0	84	42	68	24	39	0.8
180534	80 °C	F 1¼"	12.0	84	42	68	24	39	0.8

Other temperatures and dimensions on request.

LK 820 - Male thread

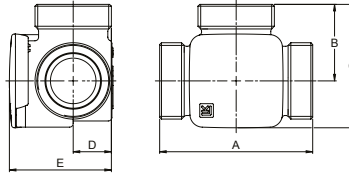

Article no.	Opening temp.	Dim.	Kvs m ³ /h	A mm	B mm	C mm	D mm	E mm	Weight kg
180503	55 °C	M ¾"	4.0	80	40	66	21	35	0.7
180504	55 °C	M 1"	6.0	80	40	66	21	35	0.7
180505	55 °C	M 1¼"	9.0	84	42	68	21	35	0.7
180506	55 °C	M 1½"	12.0	84	42	68	24	39	0.8
180512	61 °C	M 1"	6.0	80	40	66	21	35	0.7
180513	61 °C	M 1¼"	9.0	84	42	68	21	35	0.7
180514	61 °C	M 1½"	12.0	84	42	68	24	39	0.8
180520	66 °C	M 1"	6.0	80	40	66	21	35	0.7
180528	72 °C	M 1"	6.0	80	40	66	21	35	0.7
180530	72 °C	M 1½"	12.0	84	42	68	24	39	0.8

Other temperatures and dimensions on request.

LK 820 - Compression fitting

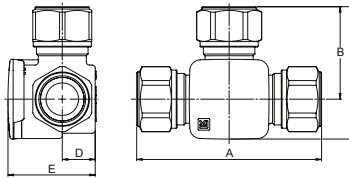

Article no.	Opening temp.	Dim.	Kvs m ³ /h	A mm	B mm	C mm	D mm	E mm	Weight kg
181125	61 °C	22 mm	6.0	114	57	83	21	35	0.8

Other temperatures and dimensions on request.

SPARE PARTS AND ACCESSORIES

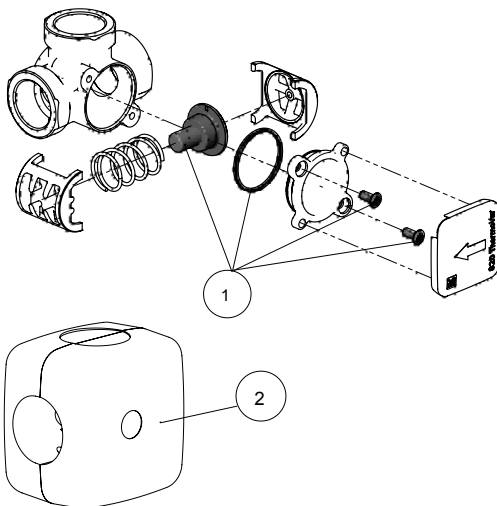

Article no.	Article	Position
187025	Thermostatic element 820, 45 °C	1
187026	Thermostatic element 820, 55 °C	1
187027	Thermostatic element 820, 61 °C	1
187028	Thermostatic element 820, 66 °C	1
187029	Thermostatic element 820, 72 °C	1
187030	Thermostatic element 820, 80 °C	1
187107	Insulation, DN 15-20	2
187108	Insulation, DN 25-32	2

Thermic Zone Valve

LK 821 ThermoVar®



- Position-independent



TECHNICAL DATA

Max. working pressure	1.0 MPa (10 bar)
Max. differential pressure	50 kPa (0.5 bar)
Working temperature	(45 - 55 °C) Min. 5 °C/Max. 95 °C (61 - 80 °C) Min. 5 °C/Max. 110 °C
Opening temperature	45 °C, 55 °C, 61 °C, 66 °C, 72 °C or 80 °C
Ambient temperature	Min. 5 °C/Max. 60 °C
Thread standard	Rp - female thread, G - male thread
Media	Water - Glycol mixture max. 50%
Material, valve body	Brass EN 12165 CW617N
Material, external cover	Brass EN 12165 CW617N
Material, sealing	EPDM

LK 821 ThermoVar® 3-way thermic zone valve is designed to change the direction of flow of the media in heating systems. The valve is controlled by the temperature of the media. With an LK 821 ThermoVar® installed in, for example, a solar heating system an optimal stratification in the storage tank is obtained.

LK 821 can be equipped with an insulation - see under Accessories. For more information, please see the product sheet for insulations.

The valve can be mounted at any angle. LK 821 ThermoVar® can easily be adapted for right- or left-hand mounting.

CAPACITY DIAGRAM

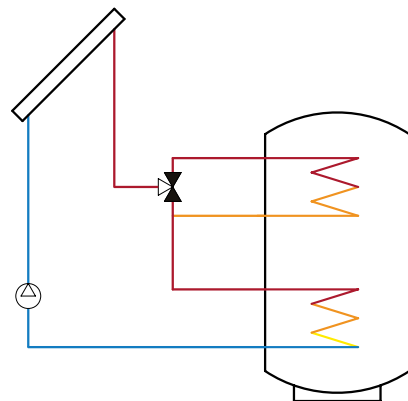
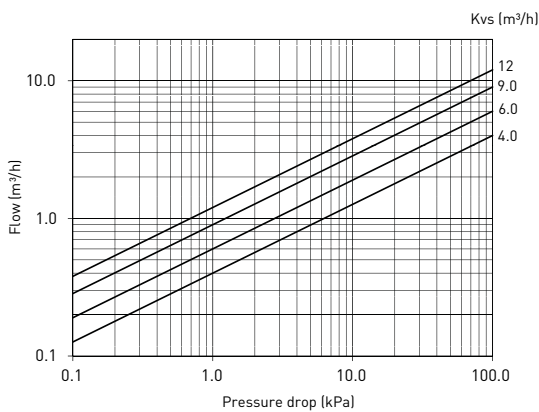

LK 821 - Female thread

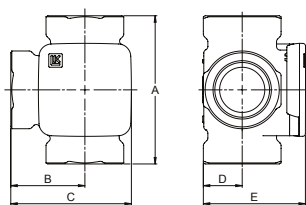

Article no.	Opening temp.	Dim.	Kvs m ³ /h	A mm	B mm	C mm	D mm	E mm	Weight kg
180540	45 °C	F ¾"	6.0	80	40	66	21	35	0.8
180541	45 °C	F 1"	9.0	82	41	67	21	35	0.9
180549	55 °C	F 1"	9.0	82	41	67	21	35	0.9
180573	72 °C	F 1"	9.0	82	41	67	21	35	0.9

Other temperatures and dimensions on request.

LK 821 - Male thread

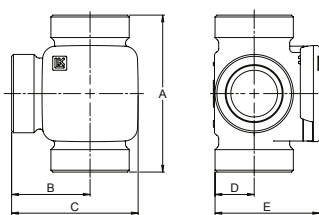

Article no.	Opening temp.	Dim.	Kvs m ³ /h	A mm	B mm	C mm	D mm	E mm	Weight kg
180544	45 °C	M 1"	6.0	80	40	66	21	35	0.8
180578	72 °C	M 1½"	12.0	84	42	68	24	39	1.0

Other temperatures and dimensions on request.

SPARE PARTS AND ACCESSORIES

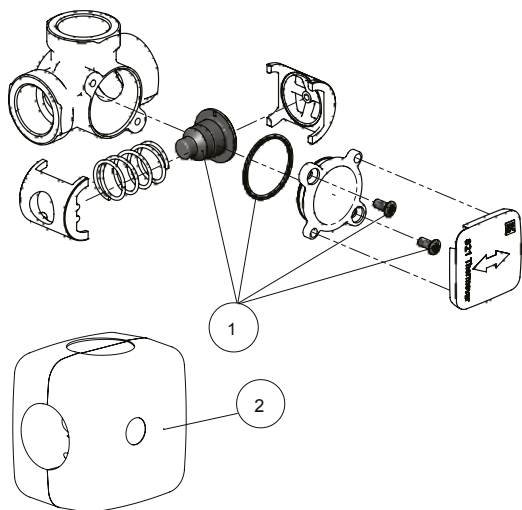

Article no.	Article	Position
187031	Thermostatic element 821, 45 °C	1
187032	Thermostatic element 821, 55 °C	1
187033	Thermostatic element 821, 61 °C	1
187034	Thermostatic element 821, 66 °C	1
187035	Thermostatic element 821, 72 °C	1
187036	Thermostatic element 821, 80 °C	1
187107	Insulation, DN 15-20	2
187108	Insulation, DN 25-32	2

Check Valve

LK 822 ThermoBac



TECHNICAL DATA

Max. working pressure	1.0 MPa (10 bar)
Max. differential pressure	50 kPa (0,5 bar)
Working temperature	Min. 5 °C/Max. 110 °C
Ambient temperature	Min. 5 °C/Max. 60 °C
Thread standard	Rp - female thread, G - male thread
Media	Water - Glycol mixture max. 50%
Material, valve body	Brass EN 12165 CW617N
Material, external cover	Brass EN 12165 CW617N
Material, sealing	EPDM

LK 822 ThermoBac is a 3-way check valve with low opening pressure and high fluid capacity. The valve is especially suitable for heating systems with storage tanks. The check valve prevents self-circulation from storage tank to boiler after the fire has gone out. In case of power failure or pump breakdown LK 822 ThermoBac automatically opens for self-circulation.

LK 822 can be equipped with an insulation - see under Accessories. For more information please see the product sheet for insulations.

The valve should be mounted so that the flap in the check valve closes by its own weight.

CAPACITY DIAGRAM

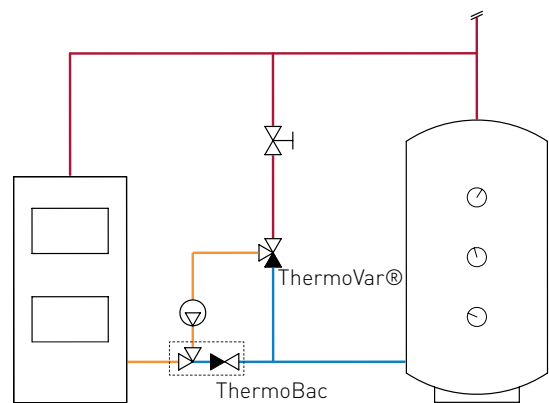
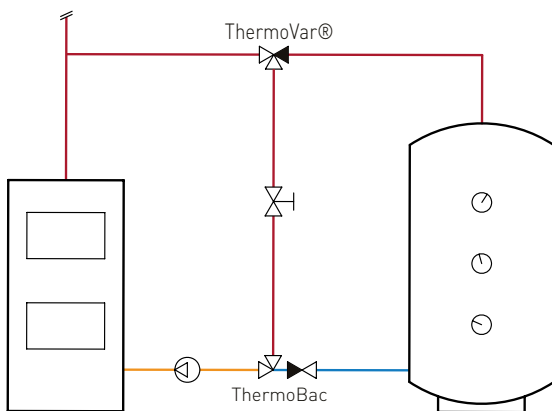
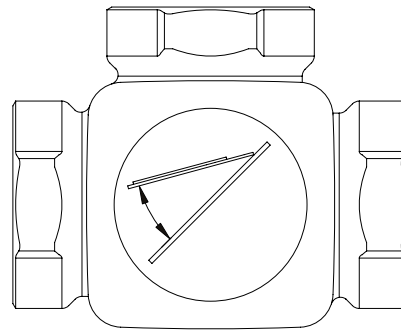
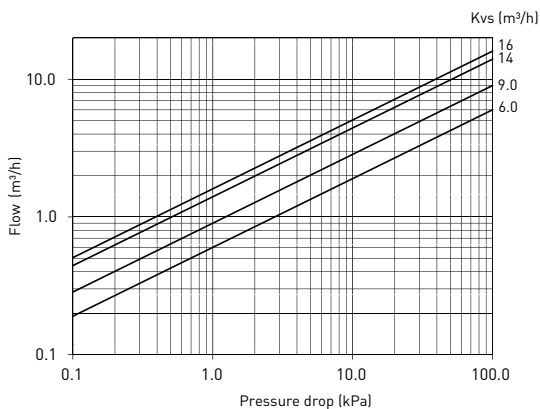

LK 822 - Female thread

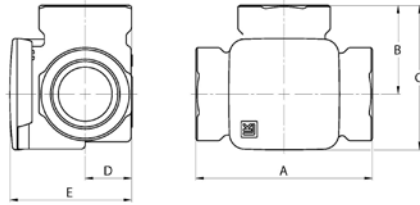

Article no.	Dim.	Kvs m ³ /h	A mm	B mm	C mm	D mm	E mm	Weight kg
181109	F 1"	14.0	82	41	67	21	35	0.7
181110	F 1¼"	16.0	84	42	68	24	39	0.7

Other dimensions on request.

SPARE PARTS AND ACCESSORIES

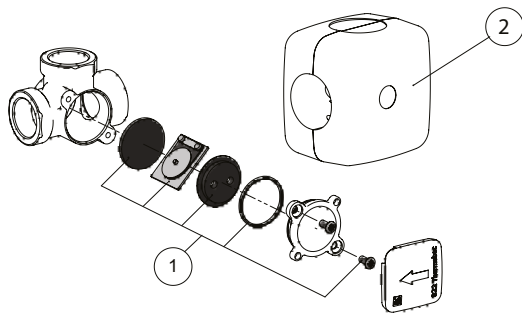

Article no.	Article	Position
187072	Repair kit 822, DN 15-32	1
187107	Insulation, DN 15-20	2
187108	Insulation, DN 25-32	2

Thermic Loading Valve

LK 823 ThermoVar®

- Increases the efficiency of the system
- Prevents condensation and taring
- Ensures an optimal temperature stratification in the storage tank



TECHNICAL DATA

Leakage	< 0.5% of Kvs at 100 kPa
Max. working pressure	1.0 MPa (10 bar)
Max. differential pressure	100 kPa (1 bar)
Working temperature	(45 - 55 °C) Min. 5 °C/Max. 95 °C (60 - 70 °C) Min. 5 °C/Max. 110 °C
Opening temperature	45 °C, 50 °C, 55 °C, 60 °C, 65 °C or 70 °C
Ambient temperature	Min. 5 °C/Max. 60 °C
Thread standard	Rp - female thread, G - male thread
Media	Water - Glycol mixture max. 50%
Material, valve body	Brass EN 1982 CB753S
Material, internal cover	Brass EN 12165 CW617N
Material, sealing	EPDM

LK 823 ThermoVar® is a 3-way thermic loading valve for solid fuel/storage tank installations. The valve is intended to ensure both an optimal temperature stratification in the storage tank and a high return temperature to the boiler, thus increasing the efficiency of the system. Tarring and condensation are prevented which prolongs boiler life.

The valve regulates on two ports, which means that there is no need for a balancing valve in the circuit between boiler and loading valve. The thermostatic element starts to open port A when the outgoing mixed water temperature in port AB reaches the opening temperature. Port B is closed when the temperature in port A exceeds the nominal opening temperature by 10 °C.

LK 823 can be equipped with an insulation - see under Accessories. For more information, please see the product sheet for insulations.

The valve can be mounted at any angle. LK 823 ThermoVar® is for right- or left-hand mounting.

CAPACITY DIAGRAM

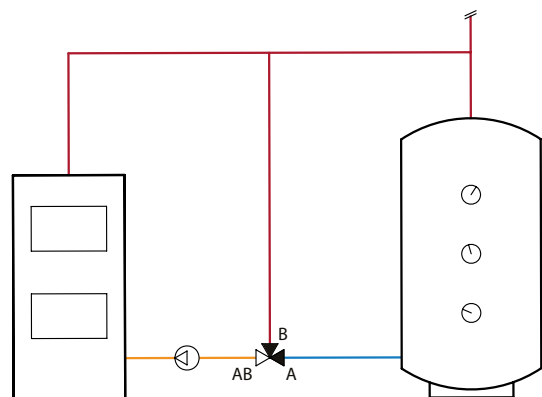
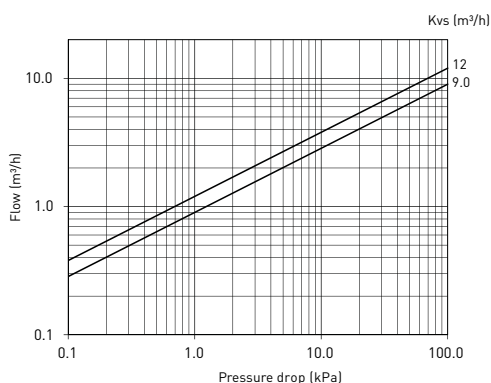

LK 823 - Female thread

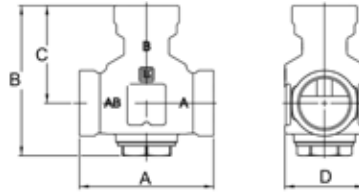

Article no.	Opening temp.	Dim.	Kvs m ³ /h	A mm	B mm	C mm	D mm	Weight kg
181284	45 °C	F 1"	9.0	92	114	72,5	Ø 55	1.0
181288	45 °C	F 1¼"	12.0	105	117	76	Ø 62	1.2
181285	50 °C	F 1"	9.0	92	114	72,5	Ø 55	1.0
181286	55 °C	F 1"	9.0	92	114	72,5	Ø 55	1.0
181290	55 °C	F 1¼"	12.0	105	117	76	Ø 62	1.2
181287	60 °C	F 1"	9.0	92	114	72,5	Ø 55	1.0
181291	60 °C	F 1¼"	12.0	105	117	76	Ø 62	1.2

Other temperatures and dimensions on request.

LK 823 - Male thread

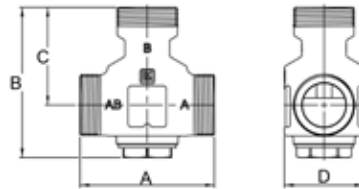

Article no.	Opening temp.	Dim.	Kvs m ³ /h	A mm	B mm	C mm	D mm	Weight kg
182163	45 °C	M 1"	9.0	84	103,5	62	Ø 55	1.0
181300	45 °C	M 1½"	12.0	105	117	76	Ø 62	1.2
182130	45 °C	M 1¼"	9.0	92	110,5	69	Ø 62	1.2
182164	50 °C	M 1"	9.0	84	103,5	62	Ø 55	1.0
182131	50 °C	M 1¼"	9.0	92	110,5	69	Ø 62	1.2
181302	55 °C	M 1½"	12.0	105	117	76	Ø 62	1.2
182132	55 °C	M 1¼"	9.0	92	110,5	69	Ø 62	1.2
181303	60 °C	M 1½"	12.0	105	117	76	Ø 62	1.2
181538	65 °C	M 1½"	12.0	105	117	76	Ø 62	1.2

Other temperatures and dimensions on request.

SPARE PARTS AND ACCESSORIES

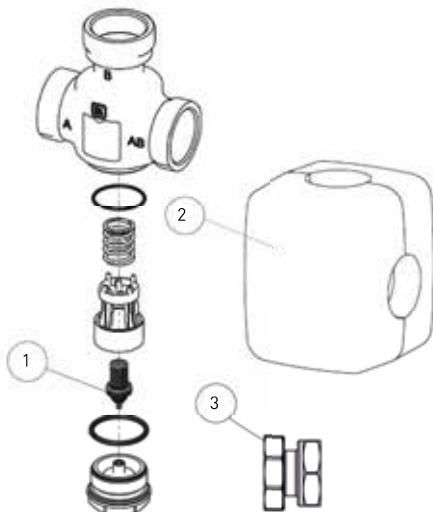

Article no.	Article	Position
187102	Thermostatic element 823, 45 °C	1
187103	Thermostatic element 823, 50 °C	1
187104	Thermostatic element 823, 55 °C	1
187105	Thermostatic element 823, 60°C	1
187138	Thermostatic element 823, 65 °C	1
187139	Thermostatic element 823, 70 °C	1
187109	Insulation, DN 25-32	2
095351	LK 823 Pump connection 1¼"	3
095352	LK 823 Pump connection 1"	3

Thermic Loading Valve

LK 823 ThermoVar® R

- Increases system efficiency
- Prevents condensation and tarring
- Adjustable temperature



TECHNICAL DATA

Leakage	< 0.5% of Kvs at 100 kPa
Max. working pressure	1.0 MPa (10 bar)
Max. differential pressure	100 kPa (1 bar)
Working temperature	Min 5 °C/Max 95 °C
Opening temperature	55 - 70 °C
Ambient temperature	Min 5 °C/Max 60 °C
Thread standard	Rp - female thread, G - male thread
Media	Water - Glycol mixture max. 50%
Material, valve body	Brass EN 1982 CB753S
Material, external cover	Brass EN 12165 CW617N
Material, sealing	EPDM

LK 823 ThermoVar® R is a 3-way thermic loading valve for solid fuel/storage tank installations. The valve is intended to ensure both an optimal temperature stratification in the storage tank and a high return temperature to the boiler, thus increasing the efficiency of the system. Tarring and condensation are prevented which prolongs boiler life.

The valve regulates on two ports, which means that there is no need for a balancing valve in the circuit between boiler and loading valve. The thermostatic element starts to open port A when the outgoing mixed water temperature in port AB reaches the opening temperature. Port B is closed when the temperature in port A exceeds the nominal opening temperature by 10 °C. The valve is adjustable within the range of 55 °C to 70 °C.

LK 823 R can be equipped with an insulation - see under Accessories. For more information, please see the product sheet for insulations.

The valve can be mounted at any angle. LK 823 ThermoVar® R is for right- or left-hand mounting.

CAPACITY DIAGRAM

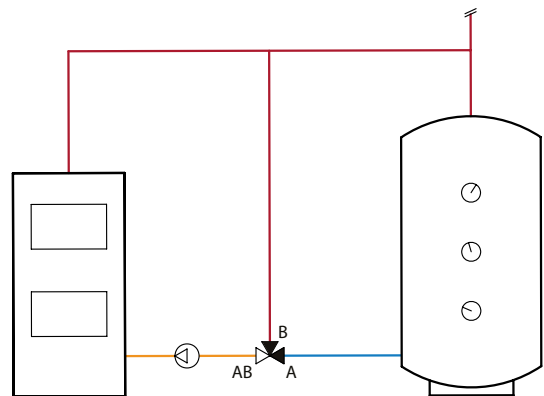
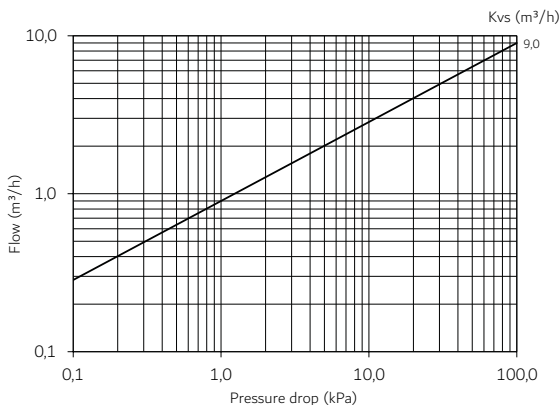

LK 823 R - Female thread

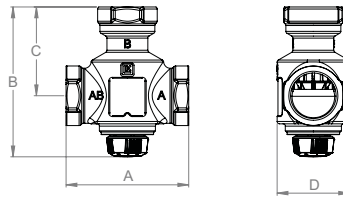

Article no.	Dim.	Kvs m ³ /h	A mm	B mm	C mm	D mm	Note	Weight kg
182386	F 1 1/4"	9.0	105	128	76	Ø 62	55 - 70 °C	1.2
182445	F 1 1/4"	9.0	105	128	76	Ø 62	45 - 60 °C	1.2

LK 823 R - Male thread

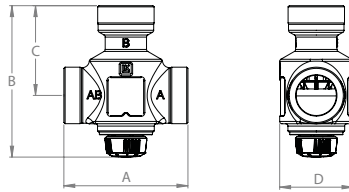

Article no.	Dim.	Kvs m ³ /h	A mm	B mm	C mm	D mm	Note	Weight kg
182388	M 1 1/2"	9.0	105	128	76	Ø 62	55 - 70 °C	1.2
182446	M 1 1/2"	9.0	105	128	76	Ø 62	45 - 60 °C	1.2

LK 823 R - Rotating nut

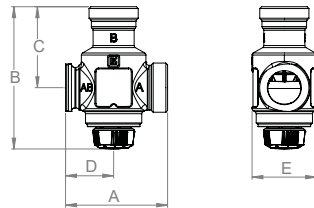

Article no.	Dim.	Dim. 2	Kvs m ³ /h	A mm	B mm	C mm	D mm	E mm	Note	Weight kg
182389	M 1 1/4"	1 1/2" Rotating nut	9.0	87	121	69	41	55	55 - 70 °C	0.9
182447	M 1 1/4"	1 1/2" Rotating nut	9.0	87	121	69	41	55	45 - 60 °C	0.9

SPARE PARTS AND ACCESSORIES

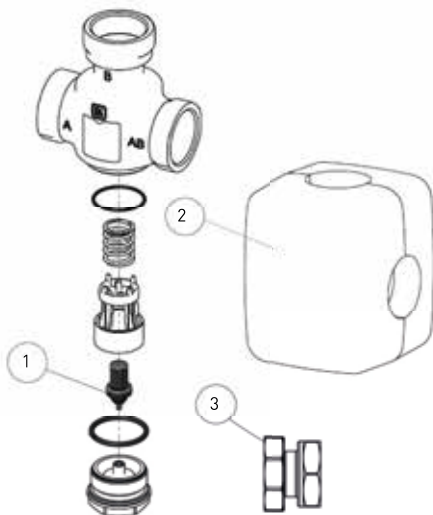

Article no.	Article	Position
187330	Repair Kit 823R	1
187310	LK Insulation, 551 (Kvs 3.2-4.2) / 552	2
095352	LK 823 Pump connection 1"	3
095351	LK 823 Pump connection 1 1/4"	3

Mixing Valves

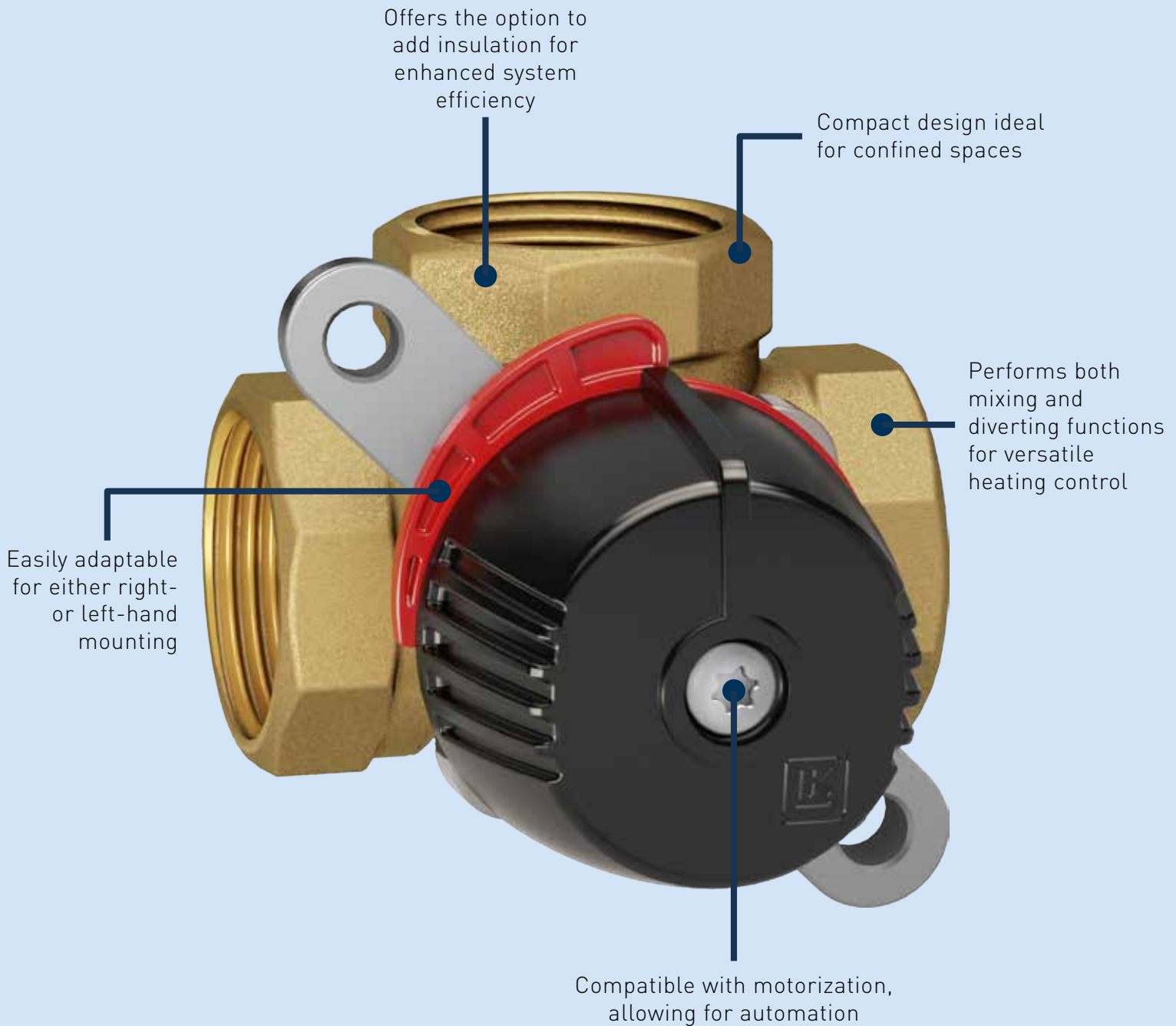

The **LK 840 ThermoMix® 2.0** is a versatile 3-way mixing valve for heating systems. It can serve as a mixing or diverting valve, is compatible with motorization, and can be insulated. With its adaptable and compact design, it can be installed in any position and is easily mounted in tight spaces.

Mixing / Diverting Valve

LK 525 MultiZone 3R

- Low internal leakage
- The slide is designed to provide accurate regulation at low flows
- Click system for actuator



TECHNICAL DATA

Voltage	230 VAC, 50 Hz
Power consumption	5 VA
Angle of rotation	90°
Torque	5 Nm
Leakage	< 0.1% of Kvs at 100 kPa
Operation time	110 s
Max. working pressure	1.0 MPa (10 bar)
Max. differential pressure	100 kPa (1 bar)
Working temperature	Min. 5 °C/Max. 80 °C (90 °C briefly)
Ambient temperature	Min. 5 °C/Max. 55 °C
Manual override	Yes
Thread standard	G - male thread, ISO 228/1
Protection type	IP 44
Protection class	II
Media	Water - Glycol mixture max. 50% Ethanol mixture max. 30%
Electrical connection	Fixed wire
Signal connector	3 point SPDT
Cable specification	3 x 0.75 mm ²
Wire colours	Blue, brown, black
External insulation	PVC
Material, valve body	Brass EN 12165 CW617N
Material, external cover	Brass EN 12164 CW614N
Material, slide/spindle	PPS Composite
Material 1	CE (Actuator only)

LK 525 MultiZone 3R is a 3-way valve that can be used as a mixing valve or as a diverting valve in heating systems.

The valve is constructed so that the leakage is less than 0.1% of Kvs at 100 kPa. It also has a split linear characteristic which means that the regulation is good even at low flows and capacities.

The valve must not be installed with the motor underneath the valve unit. Please note that the motor can be installed in only one position.

The motor operates anti clockwise when the black conductor is powered and clockwise when the brown conductor is powered.

WIRING DIAGRAM

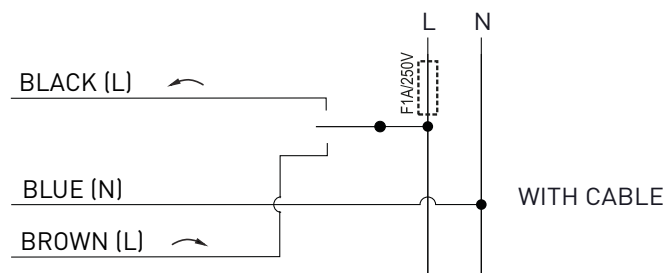

VALVE CHARACTERISTICS

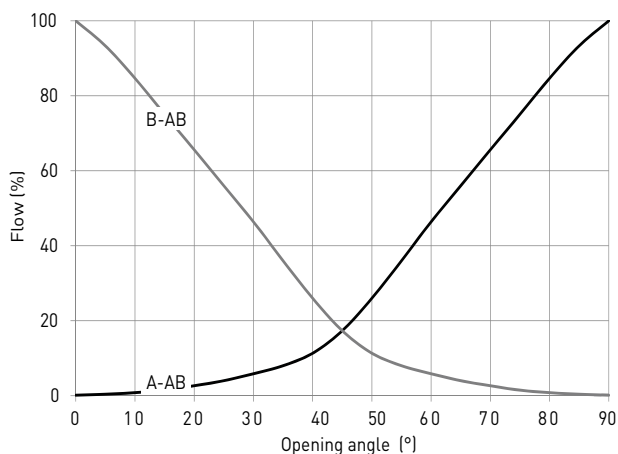

CAPACITY DIAGRAM

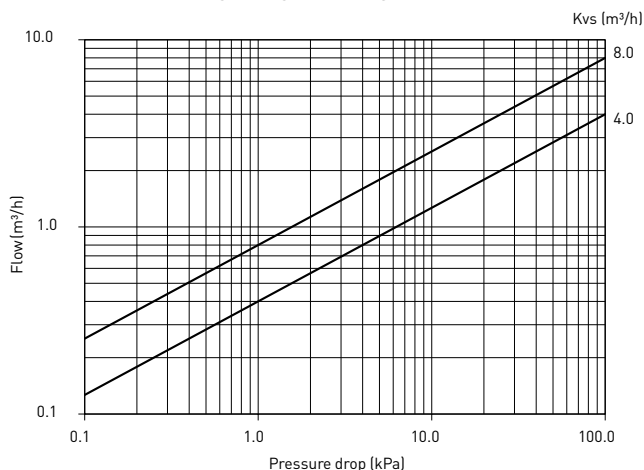

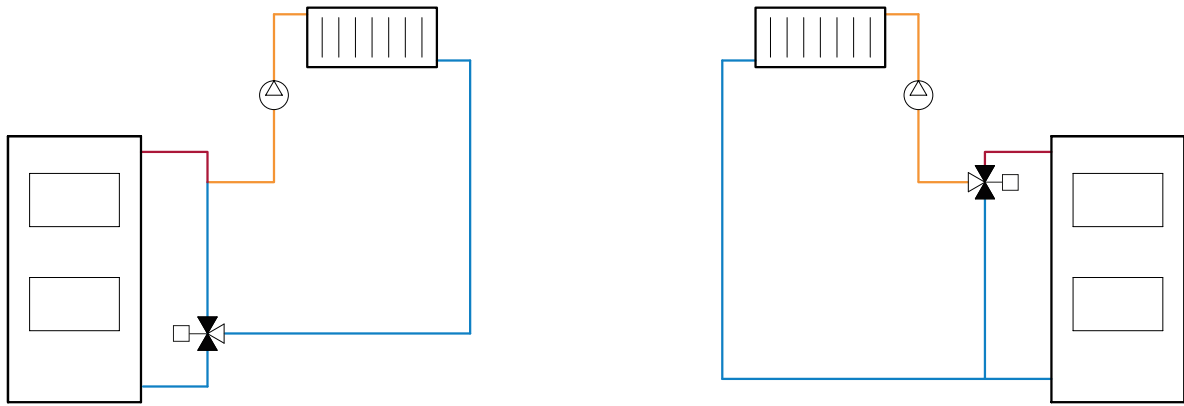

LK 525 3R - Male thread

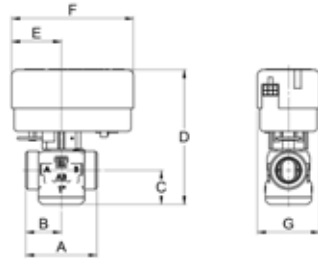

Article no.	Dim.	Kvs m ³ /h	A mm	B mm	C mm	D mm	E mm	F mm	G mm	Weight kg
066077	M 1"	8.0	62	31	39	132	46	109	58	0.3

LK 525 3R - Compression fitting

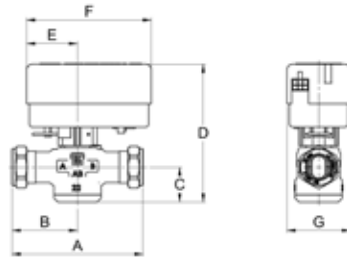

Article no.	Dim.	Kvs m ³ /h	A mm	B mm	C mm	D mm	E mm	F mm	G mm	Weight kg
066079	22 mm	8.0	110	55	50	143	46	109	58	0.4
066080	28 mm	8.0	110	55	54	147	46	109	58	0.6

LK 940 C

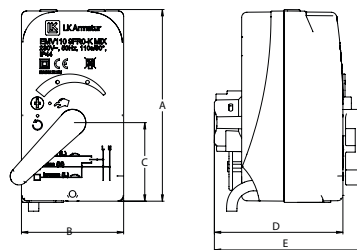

Article no.	Connection	Voltage	Torque	Operation time	A mm	B mm	C mm	D mm	E mm	Weight kg
066127	1 m cable	230 V	5 Nm	110 s*	109	58	45	73	85	0.4
066128	1 m cable 0-10 VDC	24 VAC	5 Nm	110 s*	109	58	45	73	85	0.4

SPARE PARTS AND ACCESSORIES



Article no.	Article	Position
187202	Insulation	1

Mixing valves

LK 830 ThermoMix® B

- Low internal leakage
- Easy to adapt for right- or left-hand mounting
- Suitable for motorization



TECHNICAL DATA

Angle of rotation	90°
Torque	< 1 Nm
Leakage	< 0.5% of Kvs at 50 kPa
Max. working pressure	1.0 MPa (10 bar)
Max. differential pressure	50 kPa (0.5 bar)
Working temperature	Min. 5 °C/Max. 110 °C (120 °C briefly)
Ambient temperature	Min. 5 °C/Max. 60 °C
Thread standard	Rp - female thread, G - male thread
Media	Water - Glycol mixture max. 50% Ethanol mixture max. 30%
Material, valve body	Brass EN 12165 CW617N
Material, external cover	Brass EN 12165 CW617N
Material, slide/spindle	Brass EN 12164 CW614N
Material, sealing	EPDM
Spindle sealing	Two O-rings

LK 830 ThermoMix® B 4-way bivalent mixing valves are designed for heating systems, where energy is taken from two heating units connected in series or parallel or for storage tank systems where energy is extracted from two levels.

LK 830 ThermoMix® B should be equipped with an automatic control unit to ensure that the most favourable heat source is prioritised at all times.

The valve can be mounted at any angle. Valve ports are marked 1-4. In the standard version the valve can be mounted according to 1=Supply, 2=Secondary heat, 3=Primary heat and 4=Return.

LK 830 ThermoMix® B can be adapted for right- or left-hand installation.

The valve requires no maintenance but the installation should be checked regularly.

LK 830 B AS DIVERTING VALVE WITH LK 100 SMARTCOMFORT CT TO OPTIMIZE THE STRATIFICATION IN THE TANK.

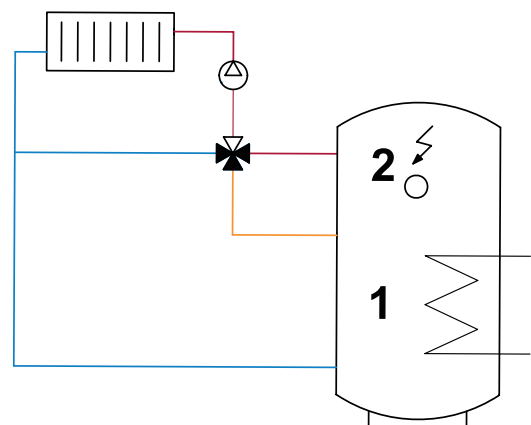
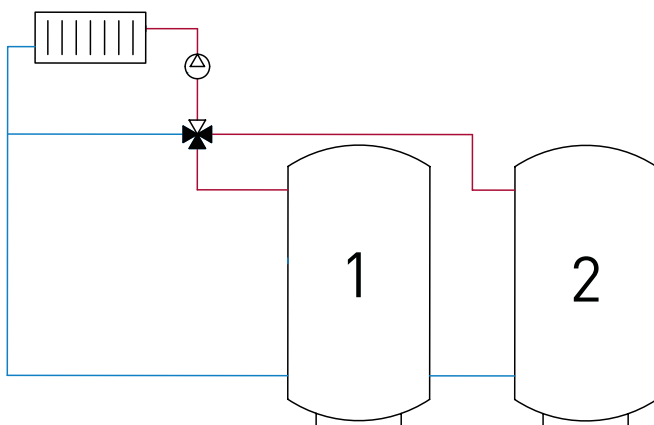
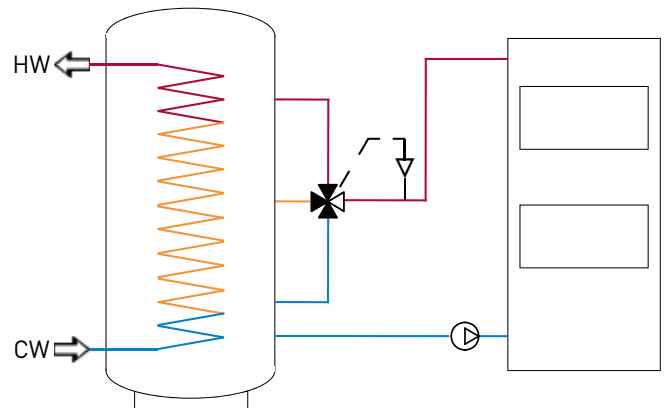

VALVE CHARACTERISTICS

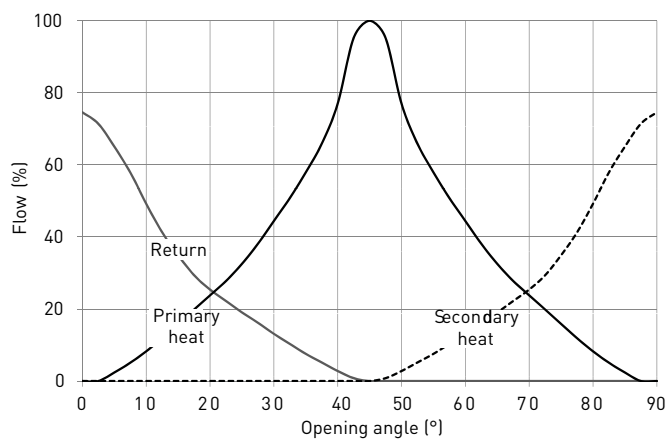

CAPACITY DIAGRAM

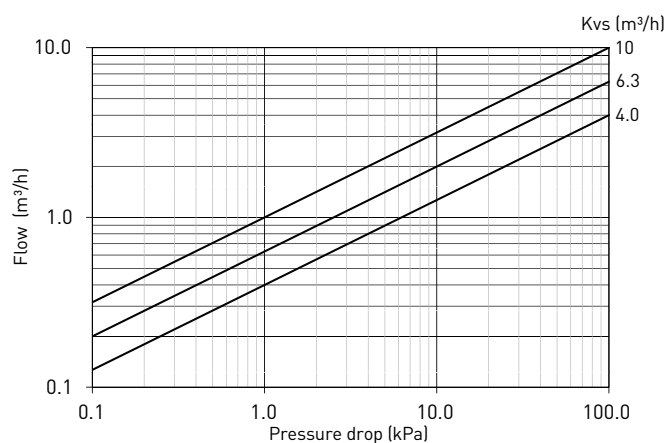

LK 830 - Female thread

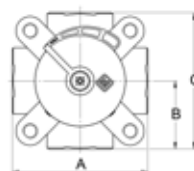
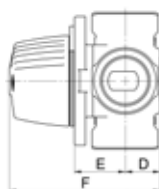

Article no.	Dim.	Kvs m ³ /h	A mm	B mm	C mm	D mm	E mm	F mm	Weight kg
180587	F 3/4"	6.3	72	36	72	19	27	80	0.7

Other dimensions on request.

LK 830 - Male thread

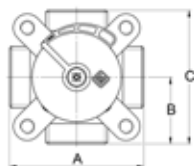

Article no.	Dim.	Kvs m ³ /h	A mm	B mm	C mm	D mm	E mm	F mm	Weight kg
180004	M 3/4"	6.3	72	36	72	20	26	80	0.6
180588	M 1"	6.3	72	36	72	19	27	80	0.7

Other dimensions on request.

LK 830 - Compression fitting

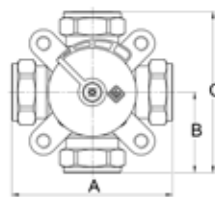
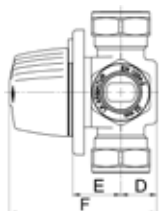

Article no.	Dim.	Kvs m ³ /h	A mm	B mm	C mm	D mm	E mm	F mm	Weight kg
180001	22 mm	4.0	87	43.5	87	20	26	80	0.7
180003	22 mm	6.3	87	43.5	87	20	26	80	0.7
180595	28 mm	6.3	112	56	112	19	27	80	1.1

Other dimensions on request.

SPARE PARTS AND ACCESSORIES

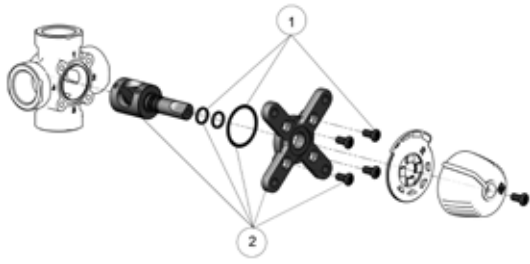

Article no.	Article	Position
187059	Sealing kit 830/831, DN 15-20	1
187060	Sealing kit 830, DN 25	1
187061	Repair kit 830, DN 15-20, Kvs 4.0	2
187062	Repair kit 830, DN 15-20, Kvs 6.3	2
187064	Repair kit 830, DN 25, Kvs 10.0	2

Bivalent Mixing Valve

LK 831 ThermoMix® B

- Easy to adapt for right- or left-hand mounting
- Suitable for motorization



TECHNICAL DATA

Angle of rotation	90°
Torque	< 1 Nm
Leakage	< 1% of Kvs at 50 kPa
Max. working pressure	1.0 MPa (10 bar)
Max. differential pressure	50 kPa (0.5 bar)
Working temperature	Min. 5 °C/Max. 110 °C (120 °C briefly)
Ambient temperature	Min. 5 °C/Max. 60 °C
Media	Water - Glycol mixture max. 50% Ethanol mixture max. 30%
Material, valve body	Brass EN 12165 CW617N
Material, external cover	Brass EN 12165 CW617N
Material, slide/spindle	Brass EN 12164 CW614N
Material, sealing	EPDM
Spindle sealing	Two O-rings

LK 831 ThermoMix® B 4-way bivalent mixing valves are designed for heating systems, where energy is taken from two heating units in series or parallel or for storage tank systems where energy is extracted from two levels.

LK 831 ThermoMix® B should be equipped with an automatic control unit to ensure that the most favourable heat source is prioritised at all times.

The valve can be mounted at any angle. Valve ports are marked 1-4. The valve is to be mounted according to 1=Supply, 2=Return, 3=Secondary heat and 4=Primary heat.

The valve requires no maintenance but the installation should be checked regularly.

VALVE CHARACTERISTICS

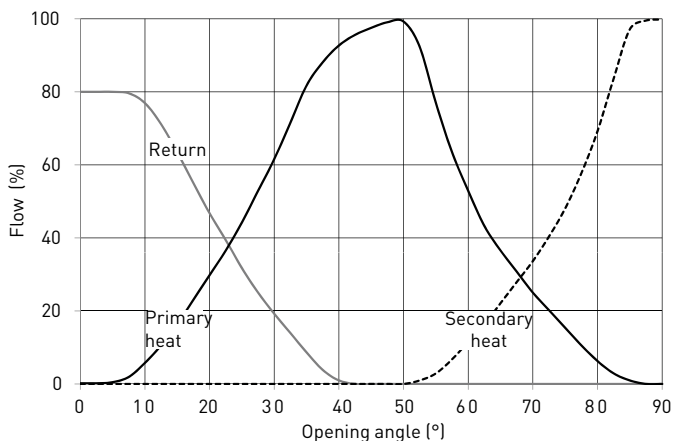

CAPACITY DIAGRAM

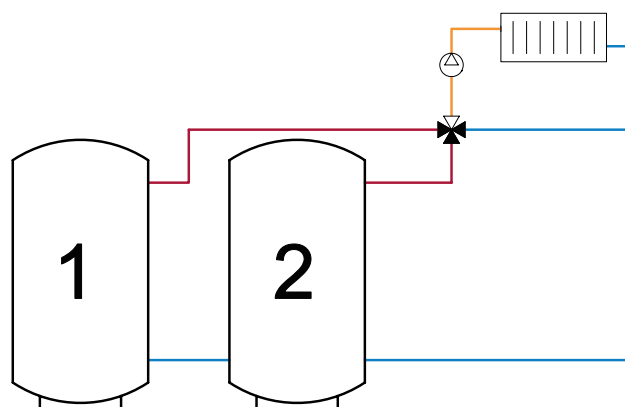
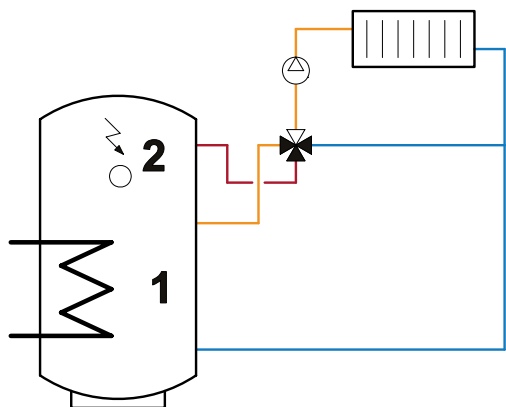
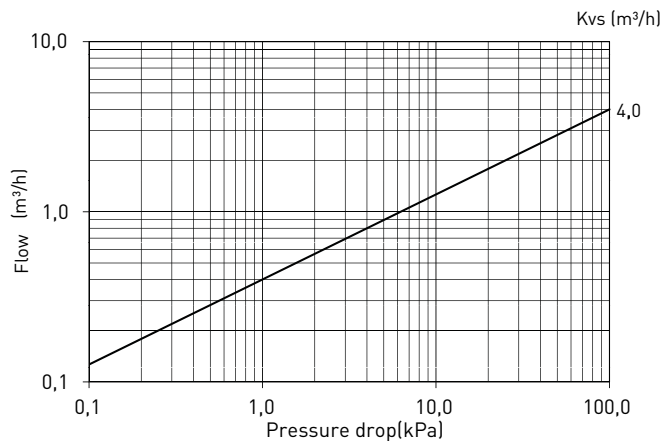

LK 831 - Compression fitting

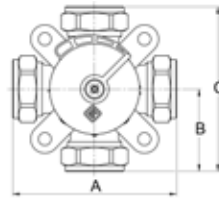
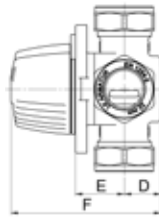

Article no.	Dim.	Kvs m ³ /h	A mm	B mm	C mm	D mm	E mm	F mm	Weight kg
180591	22 mm	4.0	87	43.5	87	20	26	80	0.7

SPARE PARTS AND ACCESSORIES

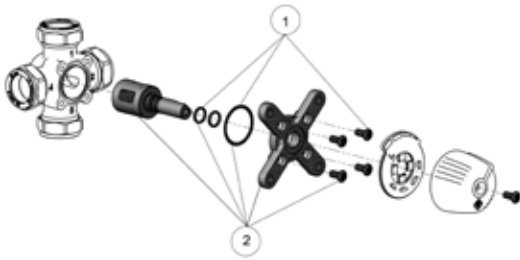

Article no.	Article	Position
187059	Sealing kit 830/831, DN 15-20	1
187065	Repair kit 831, DN 20, Kvs 4.0	2

Mixing Valve

LK 840 ThermoMix® 2.0

- Low internal leakage
- Suitable for motorization
- Broad product range



TECHNICAL DATA

Angle of rotation	90°/360°
Torque	< 1 Nm (DN15-32)* < 2,1-2,3 Nm (DN40-50)*
Leakage	< 0,2% of Kvs at 100 kPa
Max. working pressure	1.0 MPa (10 bar)
Max. differential pressure	100 kPa (1 bar)
Working temperature	Min. 5 °C/Max. 110 °C (120 °C briefly)
Ambient temperature	Min. 5 °C/Max. 60 °C
Thread standard	Rp - female thread, G - male thread
Media	Water - Glycol mixture max. 50% Ethanol mixture max. 30%
Material, valve body	Brass EN 12165 CW617N
Material, internal cover	PPS Composite
Material, slide/spindle	Brass EN 12165 CW617N
Material, sealing	EPDM
Material external cover	DN 15-32 Aluminium, DN 40-50 Composite
Spindle sealing	Two O-rings

LK 840 ThermoMix® 2.0 is a 3-way mixing valve which can be used as a mixing or diverting valve in heating systems.

LK 840 ThermoMix® 2.0 is a 3-way mixing valve which can be used as a mixing or diverting valve in heating systems. The valve is suitable for motorization and can be fitted with insulation. For more information, see the insulation data sheet.

A compact design and a octagonal key grip gives an easier access and installation in tight spaces. The valve can be installed in any position and LK 840 ThermoMix® 2.0 can easily be adapted for right- or left-hand mounting.

The valve requires no maintenance but the installation should be checked regularly.

* Double torque if the valve is used diverting.

VALVE CHARACTERISTICS

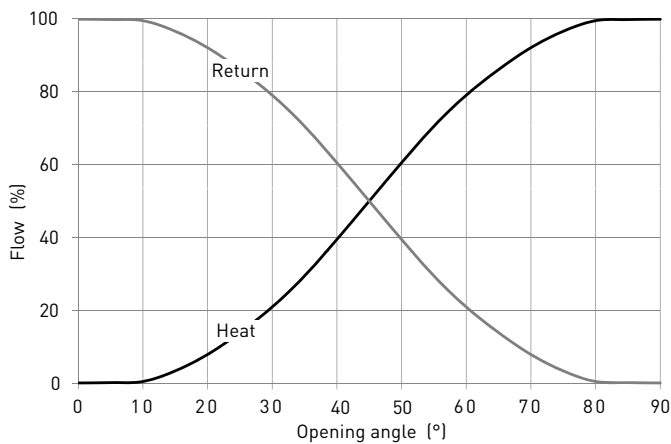

CAPACITY DIAGRAM

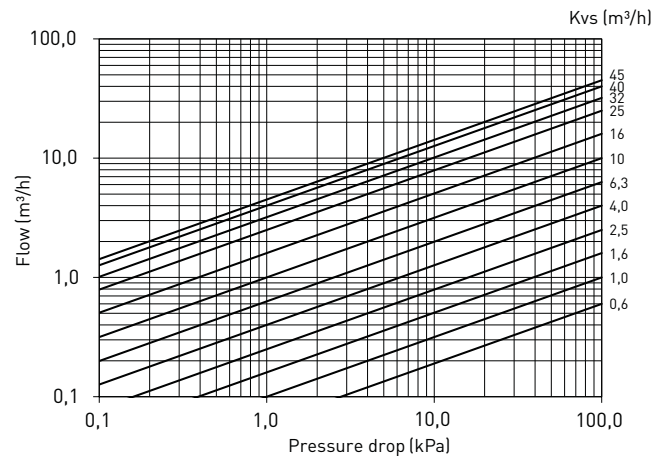

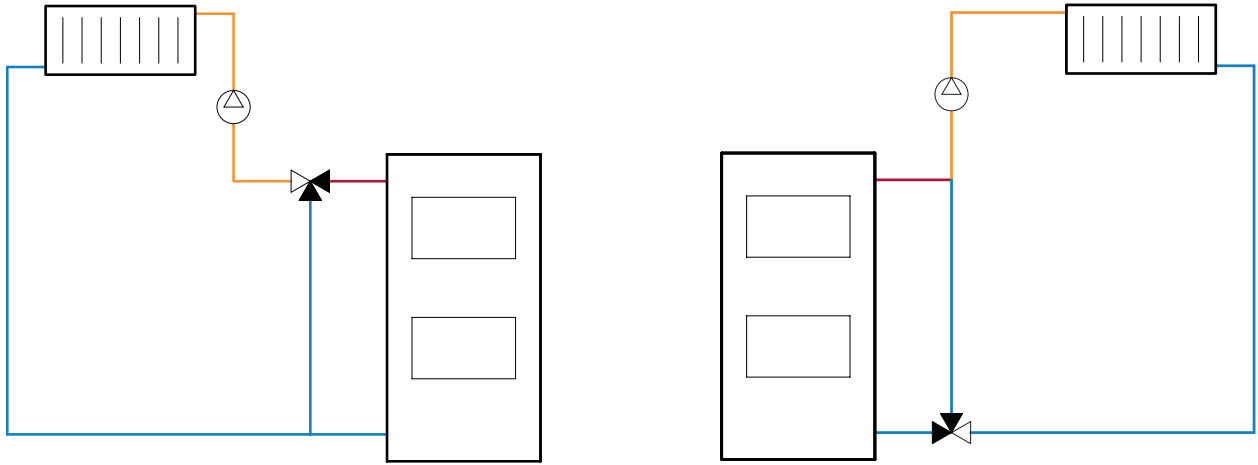

LK 840 2.0 - Female thread

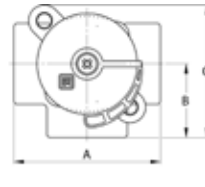
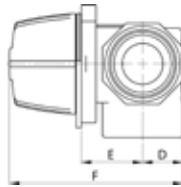

Article no.	Dim.	Kvs m ³ /h	A mm	B mm	C mm	D mm	E mm	F mm	Weight kg
181908	F 1/2"	0.6	70	35	69	18	29	81	0.5
181909	F 1/2"	1.0	70	35	69	18	29	81	0.5
181910	F 1/2"	1.6	70	35	69	18	29	81	0.5
181911	F 1/2"	2.5	70	35	69	18	29	81	0.5
181912	F 3/4"	4.0	70	35	69	18	29	81	0.5
181913	F 3/4"	6.3	70	35	69	18	29	81	0.5
181914	F 1"	6.3	70	35	69	20	29	83	0.5
181915	F 1"	10.0	70	35	69	20	29	83	0.5
181916	F 1 1/4"	16.0	84	42	77	24	32	90	0.8

LK 840 2.0 - Female thread

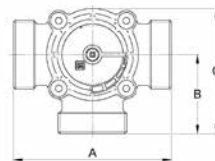
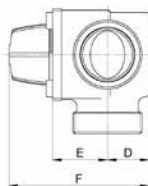

Article no.	Dim.	Kvs m ³ /h	A mm	B mm	C mm	D mm	E mm	F mm	Weight kg
181917	F 1 1/2"	25.0	106	53	88	33	43	110	1.4
181918	F 2"	40.0	106	53	88	33	43	110	1.6

LK 840 2.0 - Male thread

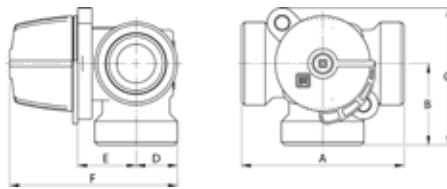

Article no.	Dim.	Kvs m ³ /h	A mm	B mm	C mm	D mm	E mm	F mm	Weight kg
181919	M ¾"	2.5	80	40	74	18	29	81	0.6
181920	M 1"	4.0	80	40	74	18	29	81	0.6
181921	M 1"	6.3	80	40	74	18	29	81	0.6
181922	M 1¼"	10.0	82	41	75	20	29	83	0.6
181923	M 1½"	16.0	84	42	77	24	32	90	0.8

LK 840 2.0 - Male thread

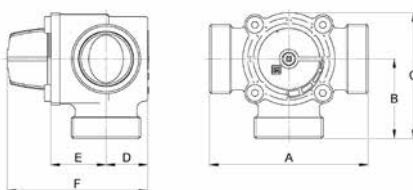

Article no.	Dim.	Kvs m ³ /h	A mm	B mm	C mm	D mm	E mm	F mm	Weight kg
181924	M 2"	25.0	124	62	97	33	43	110	1.4
181925	M 2"	32.0	124	62	97	33	43	110	1.4
181926	M 2"	45.0	124	62	97	33	43	110	1.4

LK 840 2.0 - Compression Fitting

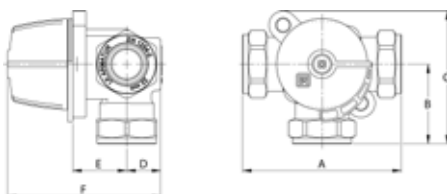

Article no.	Dim.	Kvs m ³ /h	A mm	B mm	C mm	D mm	E mm	F mm	Weight kg
181932	28 mm	6.3	120	60	94	18	29	81	0.7

Other dimensions on request.

LK 840 Set - Female thread - LK 950 / LK 100 SmartComfort CT

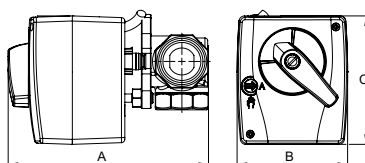

Article no.	Type	Dim.	Kvs m ³ /h	A mm	B mm	C mm	Weight kg
182759	LK 950 (180759)	F ¾"	6.3	143	80	93	1.0
182760	LK 950 (180759)	F 1"	6.3	145	80	93	1.0
182761	LK 950 (180759)	F 1"	10.0	145	80	93	1.0
182762	LK 100 (181242)	F ¾"	6.3	149	84	97	1.0
182763	LK 100 (181242)	F 1"	10.0	151	84	97	1.0

LK 850 HG - Male thread / Rotating nut

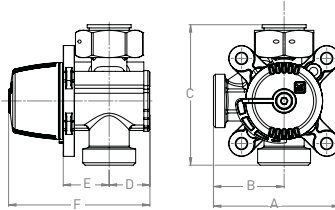

Article no.	Dim.	Kvs m ³ /h	A mm	B mm	C mm	D mm	E mm	F mm	Weight kg
182765	G 1" x G 1" x F 1" Rotating nut	6.3/10.0	78.5	44	88	25.4	28.6	88.1	0.65

LK 840 HG - Male thread / Rotating nut

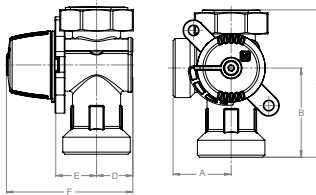

Article no.	Dim.	Kvs m ³ /h	A mm	B mm	C mm	D mm	E mm	F mm	Weight kg
182766	M 1½" x M 1¼" x F 1½" Rotating nut	6.3	41	63	104	25.6	28.8	89	0.7
182767	M 1½" x M 1¼" x F 1½" Rotating nut	10.0	41	63	104	25.6	28.8	89	0.7

SPARE PARTS AND ACCESSORIES

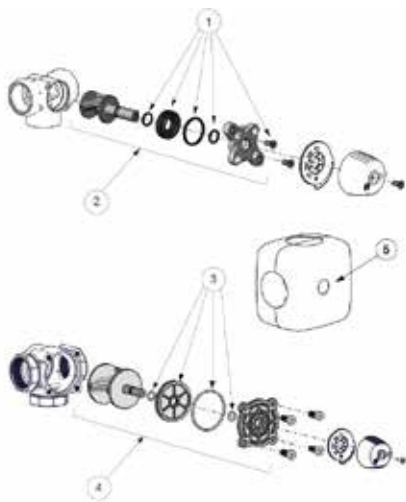

Article no.	Article	Position
187187	Sealing kit LK 840/841 DN 15-20	1
187188	Sealing kit LK 840/841 DN 25	1
187197	Sealing kit 840/841 2.0, DN 32	1
187190	Repair kit LK 840 DN 15-20	2
187191	Repair kit LK 840 DN 25	2
187192	Repair kit LK 840 DN 32	2
187189	Sealing kit 840/841 2.0, DN 40-50	3
187193	Repair kit LK 840 DN 40-50	4
187107	Insulation, DN 15-20	5
187108	Insulation, DN 25-32	5

Mixing valve

LK 840 ThermoMix® C

- Click system for actuator



TECHNICAL DATA

Angle of rotation	90°/360° (Mixing valve) 90° (Actuator - electrically limited)
Torque	< 1 Nm (Mixing valve) 5 Nm (Actuator)
Leakage	< 1% of Kvs at 50 kPa
Operation time	110 s
Max. working pressure	1.0 Mpa (10 bar)
Max. differential pressure	50 kPa (0.5 bar)
Working temperature	Min. 5 °C/Max. 110 °C (120 °C briefly)
Ambient temperature	Min. 5 °C/Max. 60 °C (Mixing valve) Min. 0 °C/Max. 50 °C (Actuator)
Position indication	Reversible scale
Direction of operation	Selectable
Manual override	Disengagement of gears
Thread standard	Rp - female thread, G - male thread
Protection type	IP 44
Protection class	II
Media	Water - Glycol mixture max. 50% Ethanol mixture max. 30%
Electrical connection	Cable 1 m
Signal connector	3-point SPDT 0 - 10 VDC/4-20 mA
Actuator	230 VAC 50 Hz 24 VAC 50 Hz
Material, valve body	Brass EN 12165 CW617N
Material, slide/spindle	Brass EN 12165 CW617N
Material, sealing	EPDM
Spindle sealing	Two O-rings

LK 840 ThermoMix C is a motorized 3-way valve that can be used as a mixing valve or as a diverting valve in heating systems.

Actuator LK 940 ThermoMix C shall be used on LK 840 ThermoMix C. Assembly/disassembly of actuator on LK 840 ThermoMix C is simple and secure, using the clip-system.

Depending on model the actuator can be operated by a controller with a 3-point SPDT output or a proportional 0-10 V / 4-20 mA output. The angle of rotation is electrically limited to 90°.

When needed, the actuator can be put into manual mode by pressing the button on the housing cover. The actuator can now be put in any position by turning the handle on the front. The position is indicated on the reversible scale.

WIRING DIAGRAM

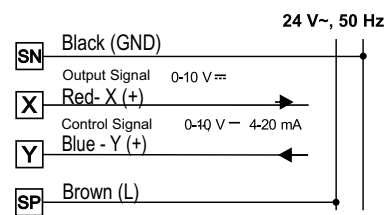
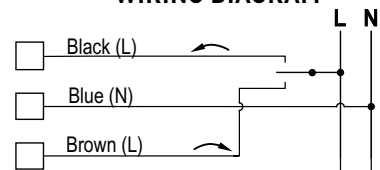

VALVE CHARACTERISTICS

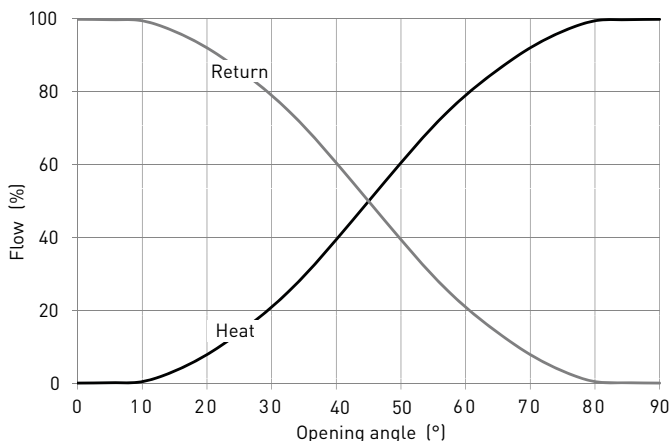

CAPACITY DIAGRAM

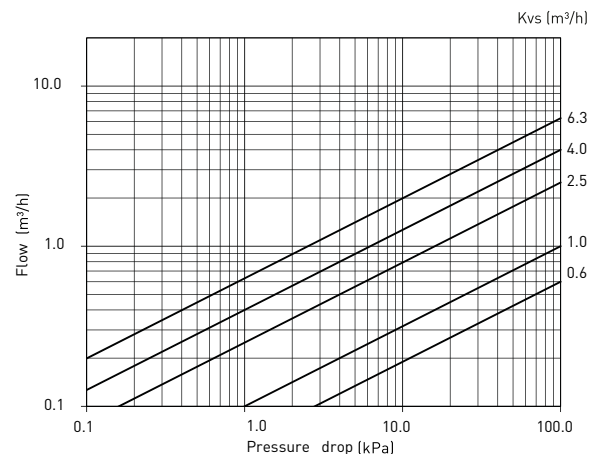

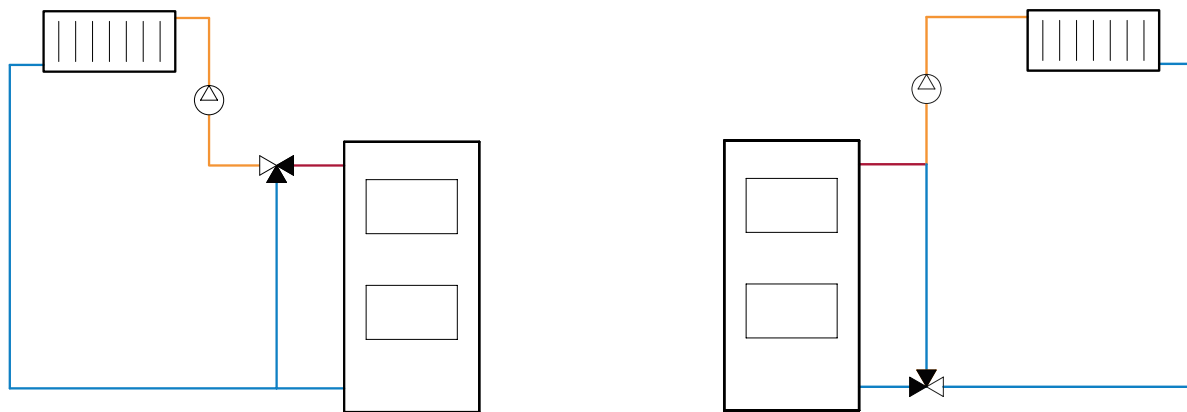

LK 840 C - Female Thread

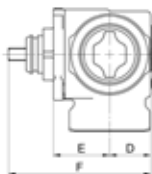

Article no.	Dim.	Kvs m ³ /h	A mm	B mm	C mm	D mm	E mm	F mm	Weight kg
181855	F 1/2"	0.6	80	40	64	20	27	71	0.7

Other dimensions on request.

LK 840 C - Male Thread

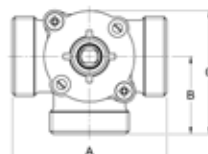
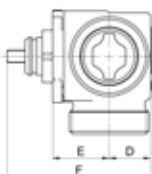

Article no.	Dim.	Kvs m ³ /h	A mm	B mm	C mm	D mm	E mm	F mm	Weight kg
181868	M 1"	6.3	80	40	64	20	27	71	0.7

Other dimensions on request.

LK 840 C - Compression fitting

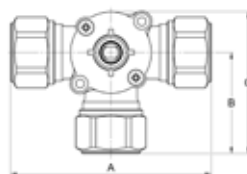
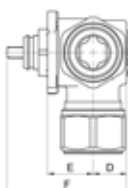

Article no.	Dim.	Kvs m ³ /h	A mm	B mm	C mm	D mm	E mm	F mm	Weight kg
181873	15 mm	2.5	114	57	81	20	27	71	0.8
181874	18 mm	2.5	114	57	81	20	27	71	0.8
181875	22 mm	2.5	114	57	81	20	27	71	0.8

LK 940 C

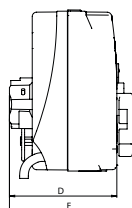
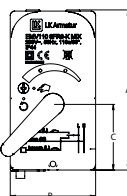

Article no.	Connection	Voltage	Torque	Operation time	A mm	B mm	C mm	D mm	E mm	Weight kg
066127	1 m cable	230 V	5 Nm	110 s*	109	58	45	73	85	0.4
066128	1 m cable 0-10 VDC	24 VAC	5 Nm	110 s*	109	58	45	73	85	0.4

Other operation times on request.

Mixing Valve

LK 841 ThermoMix® 2.0

- Octagonal key grip
- Compact design
- Low internal leakage



TECHNICAL DATA

Angle of rotation	90°/360°
Torque	< 1 Nm
Leakage	< 1.5% of Kvs at 50 kPa
Max. working pressure	1.0 MPa (10 bar)
Max. differential pressure	100 kPa (1 bar)
Working temperature	Min. 5 °C/Max. 110 °C (120 °C briefly)
Ambient temperature	Min. 5 °C/Max. 60 °C
Thread standard	Rp - female thread, G - male thread
Media	Water - Glycol mixture max. 50% Ethanol mixture max. 30%
Material, valve body	Brass EN 12165 CW617N
Material, internal cover	PPS Composite
Material, slide/spindle	Brass EN 12165 CW617N
Material, sealing	EPDM
Material, external cover	Aluminium DN 15-32, Composite DN 40-50
Spindle sealing	Two O-rings

LK 841 ThermoMix® 2.0 is designed for heating systems where a high return temperature is required to prevent corrosion and thus extend the life length of the heat source.

The valve is suitable for motorization and can be fitted with insulation. For more information, see the insulation data sheet.

A compact design and a octagonal key grip gives an easier access and installation in tight spaces. The valve can be installed in any position and LK 841 ThermoMix® 2.0 can easily be adapted for right- or left-hand mounting.

The valve requires no maintenance but the installation should be checked regularly.

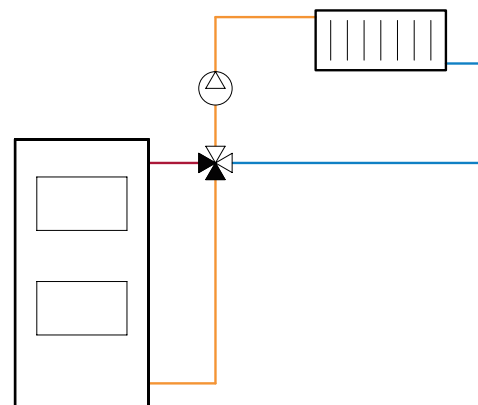

VALVE CHARACTERISTICS

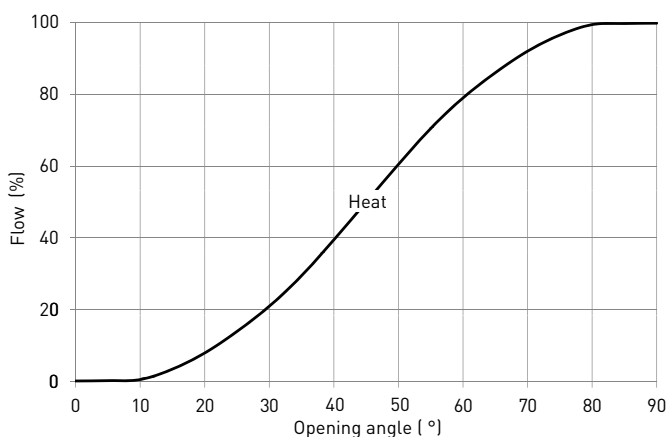

CAPACITY DIAGRAM

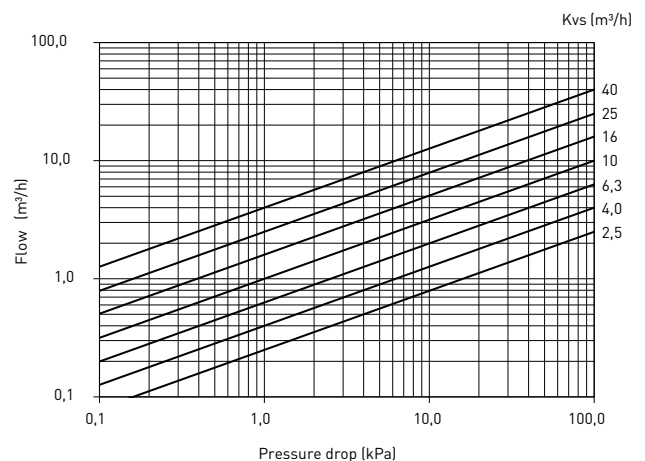

LK 841 2.0 - Female thread

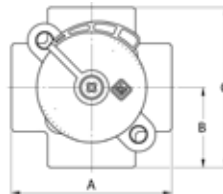
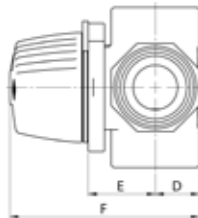

Article no.	Dim.	Kvs m ³ /h	A mm	B mm	C mm	D mm	E mm	F mm	Weight kg
181940	F 1/2"	2.5	70	35	70	18	29	81	0.7
181941	F 3/4"	4.0	70	35	70	18	29	81	0.5
181942	F 3/4"	6.3	70	35	70	18	29	81	0.5
181943	F 1"	10.0	70	35	70	20	29	83	0.5
181944	F 1 1/4"	16.0	84	42	84	24	32	90	0.8

Other dimensions on request.

LK 841 2.0 - Female thread

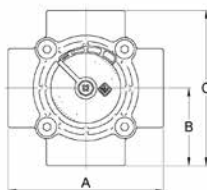
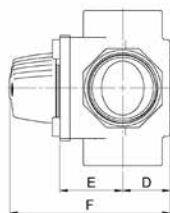

Article no.	Dim.	Kvs m ³ /h	A mm	B mm	C mm	D mm	E mm	F mm	Weight kg
181945	F 1 1/2"	25.0	106	53	106	33	43	110	1.6
181946	F 2"	40.0	106	53	106	33	43	110	1.7

Other dimensions on request.

LK 841 2.0 - Male thread

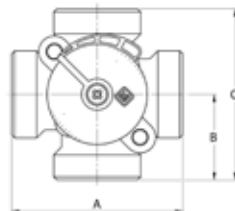

Article no.	Dim.	Kvs m ³ /h	A mm	B mm	C mm	D mm	E mm	F mm	Weight kg
181949	M 1"	6.3	80	40	80	18	29	81	0.5

Other dimensions on request.

LK 841 2.0 - Compression Fitting

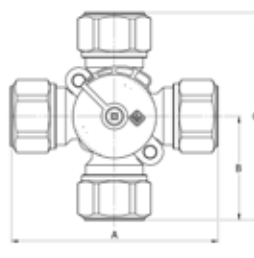
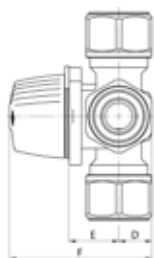

Article no.	Dim.	Kvs m ³ /h	A mm	B mm	C mm	D mm	E mm	F mm	Weight kg
181986	22 mm	2.5	114	57	114	18	29	81	0.9

Other dimensions on request.

SPARE PARTS AND ACCESSORIES

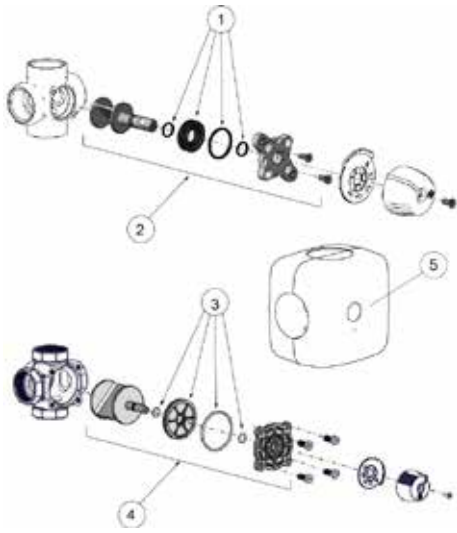

Article no.	Article	Position
187187	Sealing kit LK 840/841 DN 15-20	1
187188	Sealing kit LK 840/841 DN 25	1
187197	Sealing kit 840/841 2.0, DN 32	1
187194	Repair kit 841 2.0, DN 15-20	2
187195	Repair kit 841 2.0, DN 25	2
187198	Repair kit 841 2.0, DN 32	2
187189	Sealing kit 840/841 2.0, DN 40-50	3
187196	Repair kit 841 2.0, DN 40-50	4
187107	Insulation, DN 15-20	5
187108	Insulation, DN 25-32	5

Mixing Valves

LK 842 ThermoMix® P

- Flange connection
- Simple motorisation



TECHNICAL DATA

Angle of rotation	90°
Torque	< 1 Nm
Leakage	< 1.5% of Kvs at 50 kPa
Max. working pressure	1.0 MPa (10 bar)
Max. differential pressure	50 kPa (0,5 bar)
Working temperature	Min. 5 °C/Max. 110 °C (120 °C briefly)
Ambient temperature	Min. 5 °C/Max. 60 °C
Thread standard	G - male thread
Media	Water - Glycol mixture max. 50% Ethanol mixture max. 30%
Material, valve body	Brass EN 1982 CB753S
Material, internal cover	PPS Composite
Material, external cover	Aluminium
Material, slide/spindle	Brass EN 12165 CW617N
Material, sealing	EPDM
Spindle sealing	Two O-rings

LK 842 ThermoMix® P is a 4-way mixing valve for mounting on heating boilers.

LK 842 ThermoMix® P is suitable for motorization.

The valve can be mounted at any angle. LK 842 ThermoMix® P can easily be adapted for right- or left-hand mounting.

The valve requires no maintenance but the installation should be checked regularly.

VALVE CHARACTERISTICS

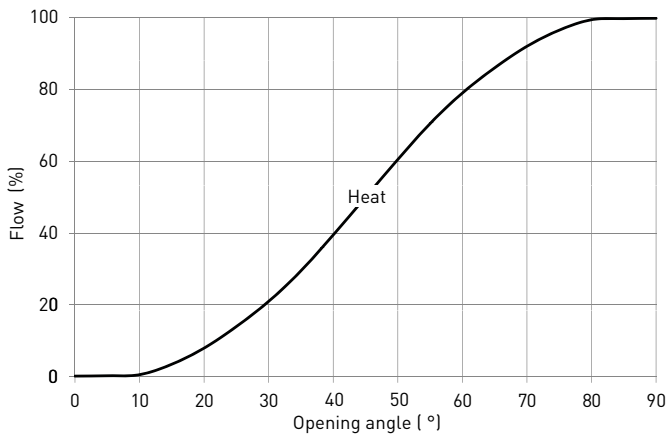

CAPACITY DIAGRAM

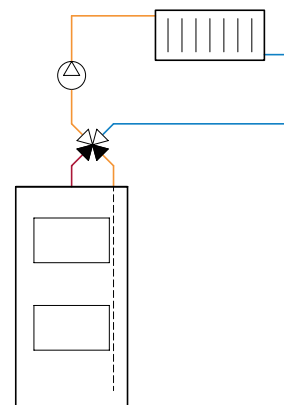
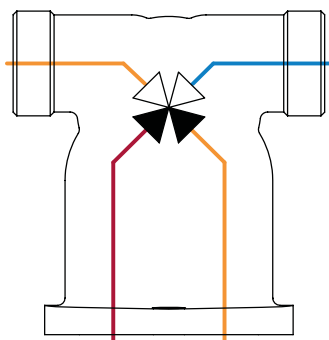
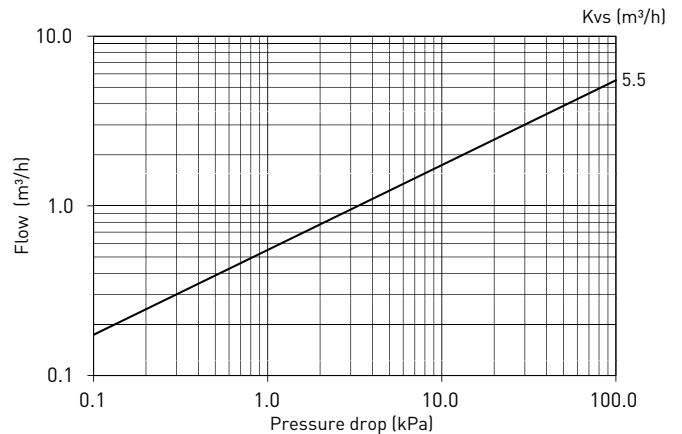

LK 842 - Male thread

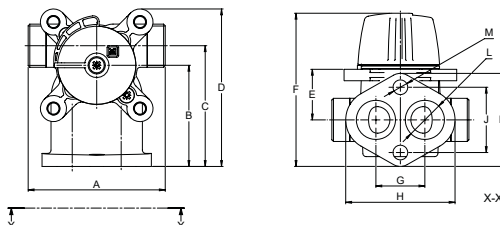

Art. no.	Dim.	Kvs m ³ /h	A mm	B mm	C mm	D mm	E mm	F mm	G mm	H mm	J mm	K mm	L mm	M mm	Wight kg
180879	M 3/4"	5.5	84	62	74	97	31	94	30	67	40	57	24	9	0.8

LK 842 - Compression fitting

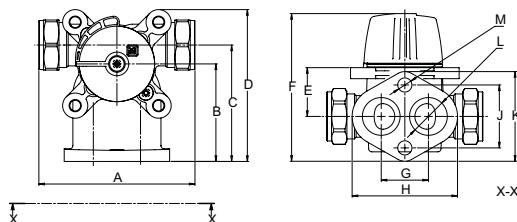

Art. no.	Dim.	Kvs m ³ /h	A mm	B mm	C mm	D mm	E mm	F mm	G mm	H mm	J mm	K mm	L mm	M mm	Wight kg
180880	15 mm	5.5	99	62	74	97	31	94	30	67	40	57	24	9	0.8
180881	22 mm	5.5	99	62	74	97	31	94	30	67	40	57	24	9	0.8

SPARE PARTS AND ACCESSORIES

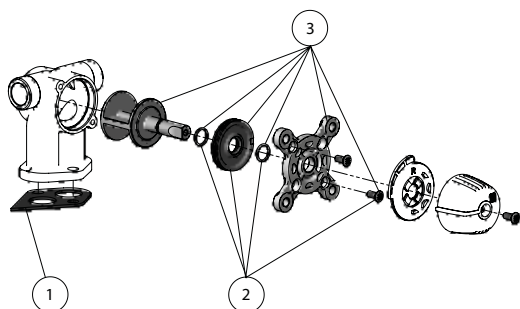

Article no.	Article	Position
013083	Gasket 842	1
187067	Sealing kit 840/841/842, DN 25-32	2
187071	Repair kit 841/842, DN 25-32	3

Mixing Valves

LK 843 ThermoMix®

- Flange connection
- Simple motorisation



TECHNICAL DATA

Angle of rotation	90°/360°
Torque	5 Nm (DN20-50) 10 Nm (DN65-100) 15 Nm (DN125-150)
Leakage	Diverting 0,75% of Kvs, Mixing 1,5% of Kvs
Max. working pressure	0.6 MPa (6 bar)
Max. differential pressure	50 kPa (0,5 bar)
Working temperature	Min. 2 °C/Max. 110 °C
Media	Water - Glycol mixture max. 50%
Material, valve body	Cast Iron EN 1561 EN-GJL-250
Material, slide/spindle	Stainless Steel EN 1.4301 (304) CW602 (DN20-80)
Material, sealing	EPDM
Media pH	Min. 7/Max. 10
Connection	Flange PN6

LK 843 ThermoMix® is a 3-way valve which can be used as a mixing valve or as a diverting valve in heating systems.

The valve can be mounted at any angle.

LK 843 ThermoMix® can easily be adapted for right-or left-hand mounting.

CAPACITY DIAGRAM

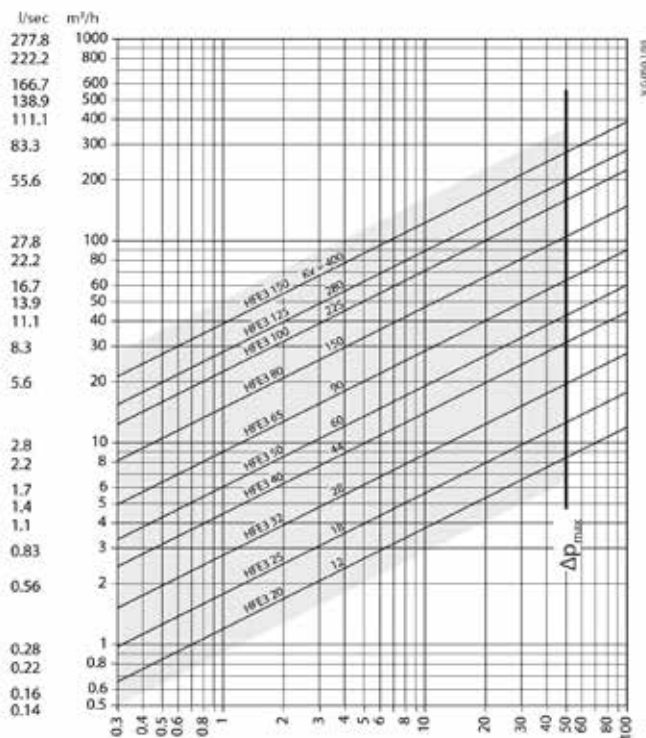

VALVE CHARACTERISTICS

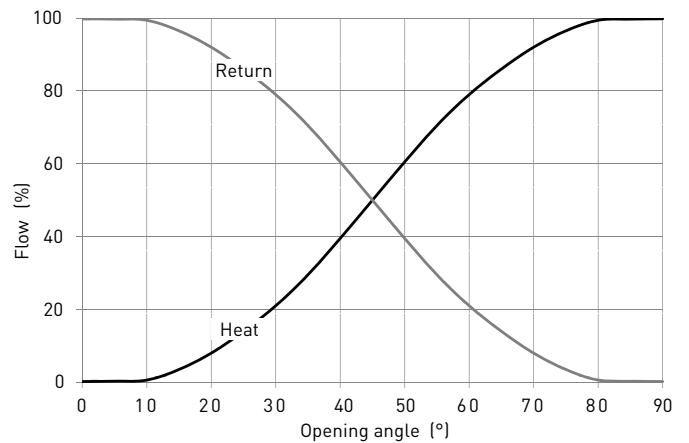

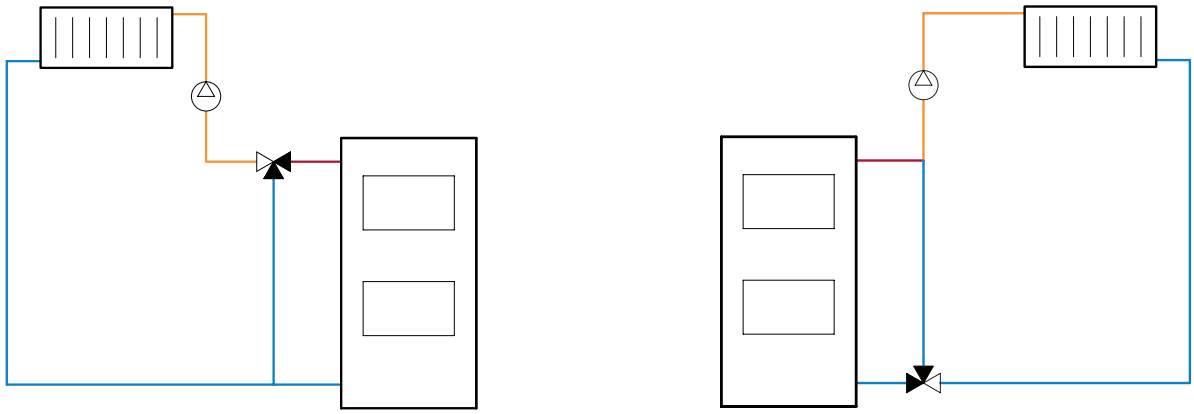

LK 843 - Flange

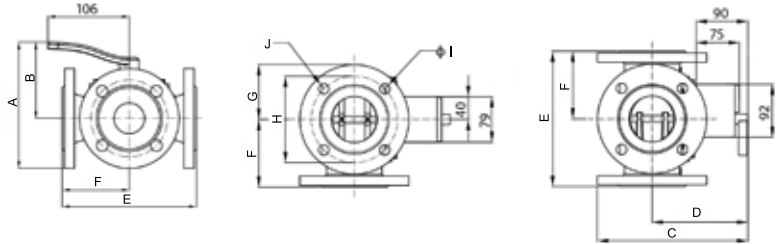

Article no.	DN	Kvs m ³ /h	A mm	B mm	C mm	D mm	E mm	F mm	G mm	H mm	I mm	J mm	Weight kg
182187	20	12.0	137	92	140	131	140	70	45	65	11.5	4	3.5
182188	25	18.0	142	92	140	136	150	75	50	75	11.5	4	4.0
182189	32	28.0	158	98	152	146	160	80	60	90	15	4	6.6
182190	40	44.0	163	98	157	146	175	88	65	100	15	4	7.2
182191	50	60.0	177	107	171	155	195	98	70	110	15	4	9.4
182192	65	90.0	187	107	181	155	200	100	80	130	15	4	11.5
182193	80	150.0	215	120	208	167	235	118	95	150	18	4	17.0
182194	100	225.0	233	128	228	177	265	133	105	170	18	4	22.5
182195	125	230.0	259	139	253	187	300	150	120	200	18	8	29.5
182196	150	400.0	277	145	271	192	350	175	133	225	18	8	40.2

SPARE PARTS AND ACCESSORIES

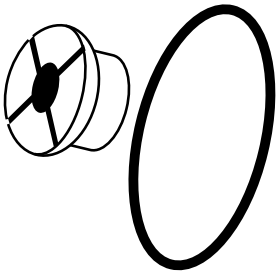

Article no.	Article	Position
187333	Sealing kit 843, DN 20-25	1
187334	Sealing kit 843, DN 32-40	1
187335	Sealing kit 843, DN 50-65	1
187336	Sealing kit 843, DN 80	1
187337	Sealing kit 843, DN 100-125	1
187338	Sealing kit 843, DN 150	1

Mixing Valve

LK 850 ThermoMix® H

- Simple motorisation
- CC 125 mm
- Bypass



TECHNICAL DATA

Angle of rotation	90°
Torque	< 3 Nm
Leakage	< 1% of Kvs at 50 kPa
Max. working pressure	1.0 MPa (10 bar)
Max. differential pressure	50 kPa (0.5 bar)
Working temperature	Min. 5 °C/Max. 110 °C (120 °C briefly)
Ambient temperature	Min. 5 °C/Max. 60 °C
Thread standard	G - male thread
Media	Water - Glycol mixture max. 50% Ethanol mixture max. 30%
Material, valve body	Brass EN 12165 CW617N
Material, external cover	Brass EN 12165 CW617N
Material, slide/spindle	Brass EN 12165 CW617N
Material, sealing	EPDM
Spindle sealing	Two O-rings

LK 850 ThermoMix® H is a 3-way mixing valve with integrated, adjustable bypass. The bypass can be adjusted up to 50% of the total valve flow.

LK 850 ThermoMix® H is suitable for motorization.

The valve can be mounted at any angle. LK 850 ThermoMix® H can easily be adapted for right- or left-hand mounting.

The valve requires no maintenance but the installation should be checked regularly.

VALVE CHARACTERISTICS

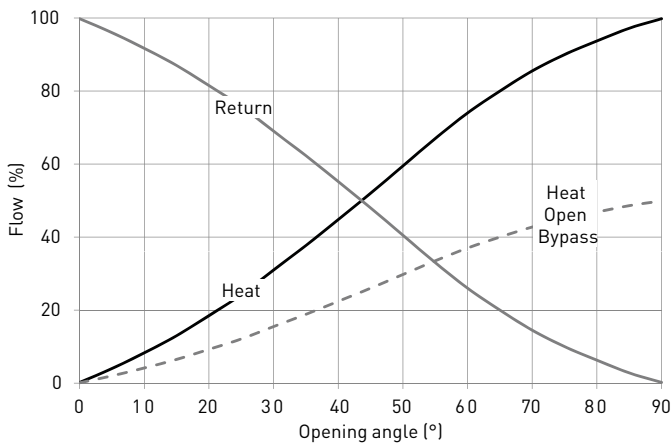

CAPACITY DIAGRAM

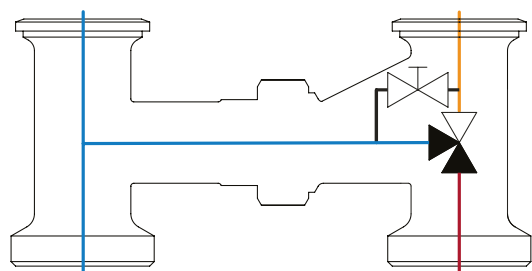
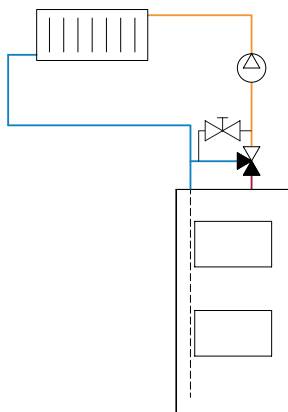
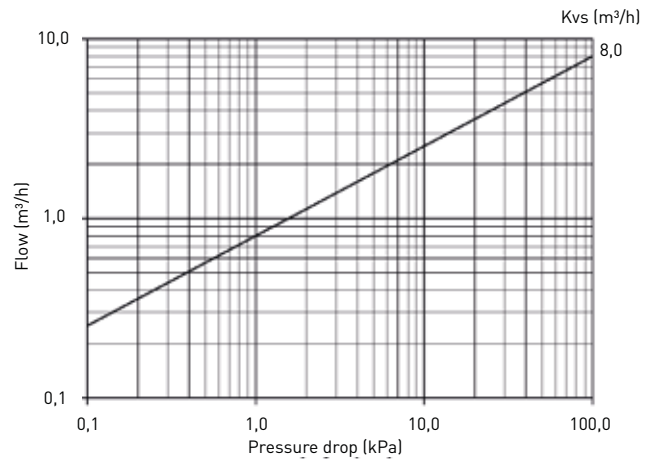

LK 850 - Male thread / Rotating nut

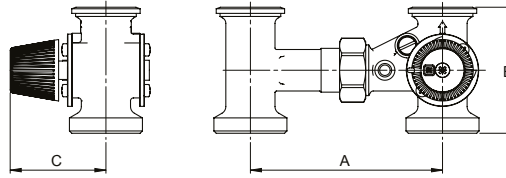

Article no.	Dim.	Kvs m ³ /h	A mm	B mm	C mm	Weight kg
181144	M 1½"	8.0	125	82	62	1.5

Two 1½" rotating nuts and two gaskets of EPDM are included in the delivery.

SPARE PARTS AND ACCESSORIES

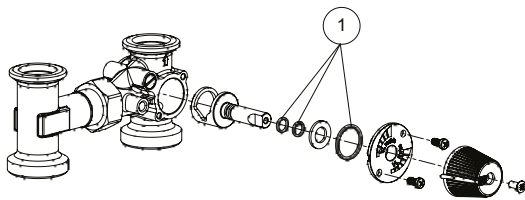

Article no.	Article	Position
187082	Sealing kit 850	1

Mixing Valve

LK 851 ThermoMix® H

- Simple motorisation
- CC 125 mm



TECHNICAL DATA

Angle of rotation	90°
Torque	< 3 Nm
Leakage	< 1% of Kvs at 50 kPa
Max. working pressure	1.0 MPa (10 bar)
Max. differential pressure	50 kPa (0.5 bar)
Working temperature	Min. 5 °C/Max. 110 °C (120 °C briefly)
Ambient temperature	Min. 5 °C/Max. 60 °C
Thread standard	G - male thread
Media	Water - Glycol mixture max. 50% Ethanol mixture max. 30%
Material, valve body	Brass EN 12165 CW617N
Material, external cover	Brass EN 12165 CW617N
Material, slide/spindle	Brass EN 12165 CW617N
Material, sealing	EPDM
Spindle sealing	Two O-rings

LK 851 ThermoMix® H is a 4-way mixing valve suited for heating systems in which a high return temperature is needed to avoid corrosion, thus prolonging the life-time of the heat source.

LK 851 ThermoMix® H is suitable for motorization.

The valve can be mounted at any angle. LK 851 ThermoMix® H can easily be adapted for right- or left-hand mounting.

The valve requires no maintenance but the installation should be checked regularly.

VALVE CHARACTERISTICS

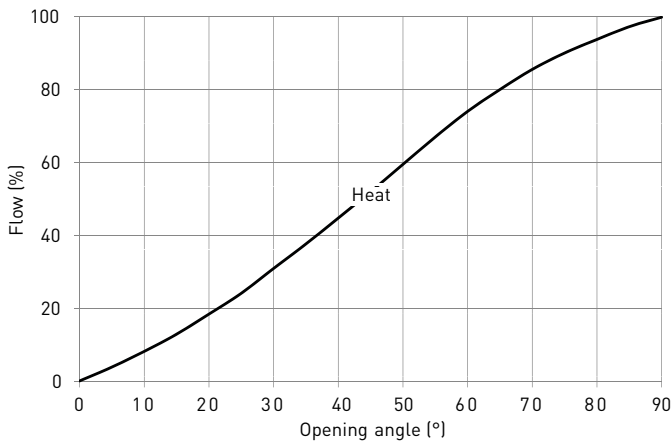

CAPACITY DIAGRAM

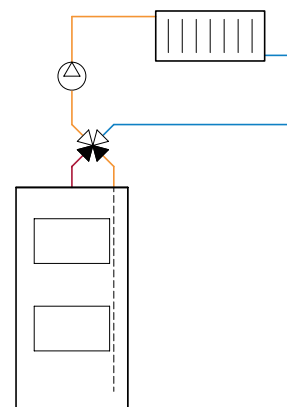
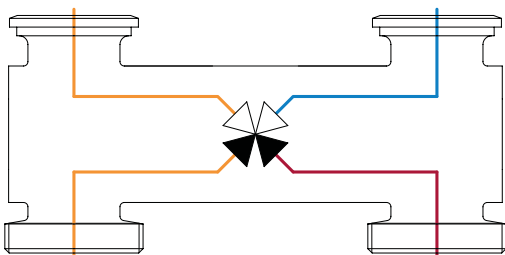
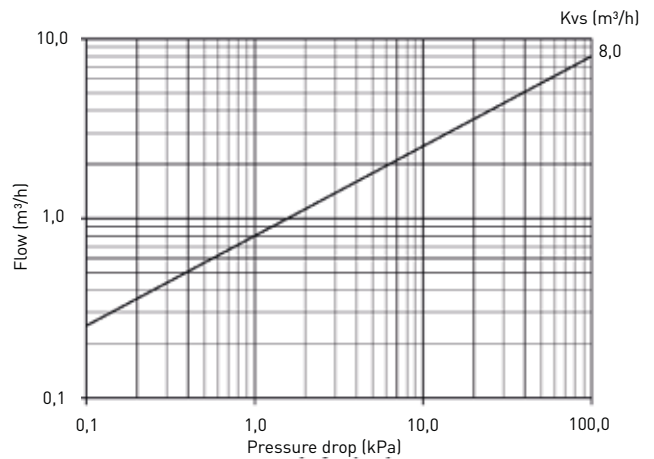

LK 851 - Male thread / Rotating nut

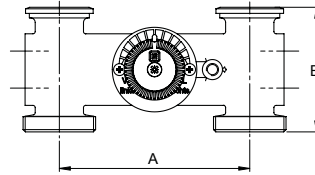
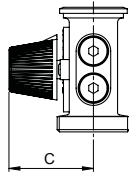

Article no.	Dim.	Kvs m ³ /h	A mm	B mm	C mm	Weight kg
181145	M 1½"	8.0	125	82	55	1.6

SPARE PARTS AND ACCESSORIES

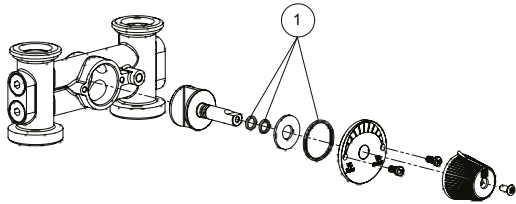

Article no.	Article	Position
187083	Sealing kit 851	1

LK SmartComfort -
Smart control of your
heating system



Temperature Controllers and Valve Actuators

Booster function for rapid indoor temperature adjustments

Nine built-in programs for energy optimization

Holiday and timer settings for convenient and energy-saving control

Available in two versions; with fixed cable SmartComfort RT or wireless receiver SmartComfort RTW

Automatically adapts to mixing valve direction for easy installation

Maintains settings during power outages

LED display shows current status and selected value

See current status of supply temperature, min. temperature, max. temperature, curve setting, and outdoor temperature



Elevate your indoor comfort with **LK 130 SmartComfort**. This intelligent controller offers precise temperature adjustments and integrates easily with existing systems. The included room temperature unit enhances control with preset programs and outdoor temperature monitoring. For top efficiency, connect SmartComfort PC to manage the circulating pump and prevent stalling.

Temperature Controllers

LK SmartComfort



- Adjustments are easily made with push buttons
- Wired or wireless room controllers available
- The same actuator for SmartComfort 110, 120 and 130 enabling easy upgrading

TECHNICAL DATA

Power consumption	< 3 VA
Primary voltage, adapter	100-240 VAC, 50/60 Hz
Secondary voltage, adapter	24 VDC
Angle of rotation	90°
Torque	5 Nm
Ambient temperature	Actuator: Min. 0 °C/Max. 50 °C (in operation) Room Temperature Unit: Min. 0 °C/Max. 40 °C
Min. supply temperature	LK 110/120/130: 5 - 40 °C
Max. supply temperature	LK 110/120/130: 20 - 99 °C
Control range	LK 100 CT: 5 - 99 °C, LK 110, 120, 130: Min. 5 °C/Max. 35 °C
Curve slope	LK 110/130: 1.0 - 9.9
Parallel displacement	LK 110/130: ± 10 °C
Protection class	Actuator: IP 40 Room Temperature Unit: IP 20



LK SmartComfort is an electronic controller that has an automatic choice of direction to adapt to the direction of the mixing valve. LED-indicators show if the controller is opening or closing the valve. The supply temperature can be limited with a minimum and a maximum value. LED-indicators show if the controller is opening or closing the valve. Adjustments are easily made with the push buttons marked "+" and "-". The selected value will be shown on the LED-display.

LK SmartComfort is easy to install onto new as well as existing mixing valves. Mounting kits for installation onto mixing valves of other brands are available - see separate page.

The plug-in adapter provides quick and easy do-it-yourself installation. In case of a power outage the controller will keep its settings and the actuator will stop in its current position. By disengaging the controller, the mixing valve can be manually operated.

LK 100 CT - CONSTANT TEMPERATURE CONTROLLER

LK 100 SmartComfort CT is an electronic temperature controller designed to keep the supply temperature in underfloor heating systems or the return temperature to solid fuel boilers at a constant level. The flow temperature is adjustable between 5 - 99 °C.

LK 100 CT - ITEMS INCLUDED

- Temperature controller
- Adapter 24 VDC
- Mounting kit for mixing valve
- Supply temperature sensor with 1 m cable



LK 100 SMARTCOMFORT CT

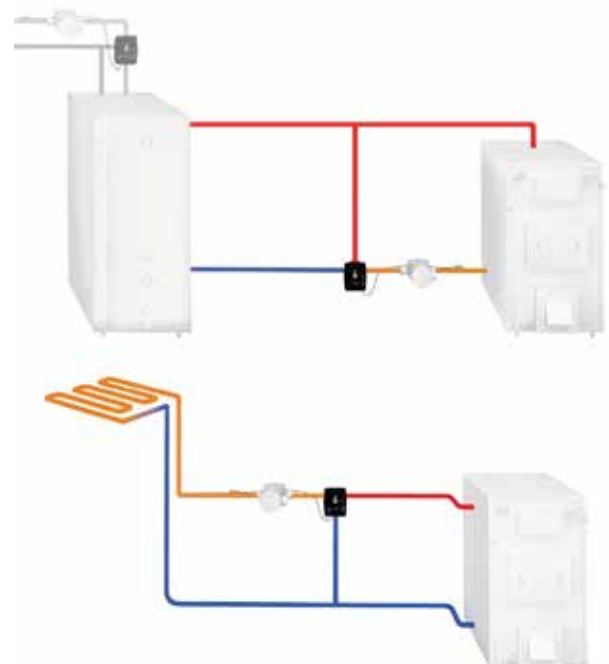

LK 110 - WEATHER COMPENSATED TEMPERATURE CONTROLLER

LK 110 SmartComfort is an electronic weather compensated temperature controller for hydronic radiator and underfloor heating systems. By measuring the supply and outdoor temperatures LK 110 SmartComfort regulates the mixing valve to provide the system with the exact amount of heat required in the building at any given time. The supply temperature can be limited with a minimum and a maximum value. The current supply and outdoor temperatures can be read on the controller display.

LK 110 - ITEMS INCLUDED

- Temperature controller
- Adapter 24 VDC
- Mounting kit for mixing valve
- Supply temperature sensor with 1 m cable
- Outdoor temperature sensor with 15 m cable and protective casing



LK 110 SMARTCOMFORT

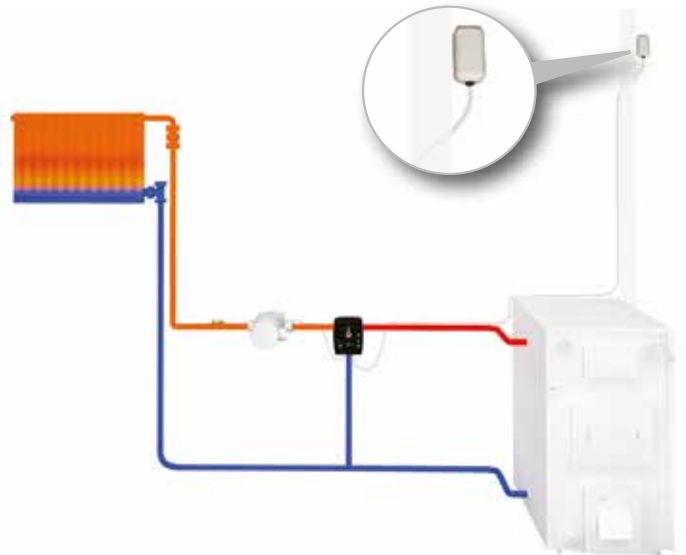

LK 120 - INDOOR TEMPERATURE CONTROLLER

LK 120 SmartComfort is an electronic indoor temperature controller for hydronic radiator and underfloor heating systems. By measuring the supply and indoor temperatures LK 120 SmartComfort regulates the mixing valve to provide the system with the exact amount of heat required in the building at any given time. The supply temperature can be limited with a minimum and a maximum value.

LK 120 SmartComfort is delivered with a room temperature unit allowing easy setting of the desired indoor temperature.

LK 120 - ITEMS INCLUDED

- Temperature controller
- Adapter 24 VDC
- Mounting kit for mixing valve
- Supply temperature sensor with 1 m cable
- Room temperature unit SmartComfort RT with 15 m cable or Room temperature unit SmartComfort RTW with wireless receiver



LK 120 SMARTCOMFORT

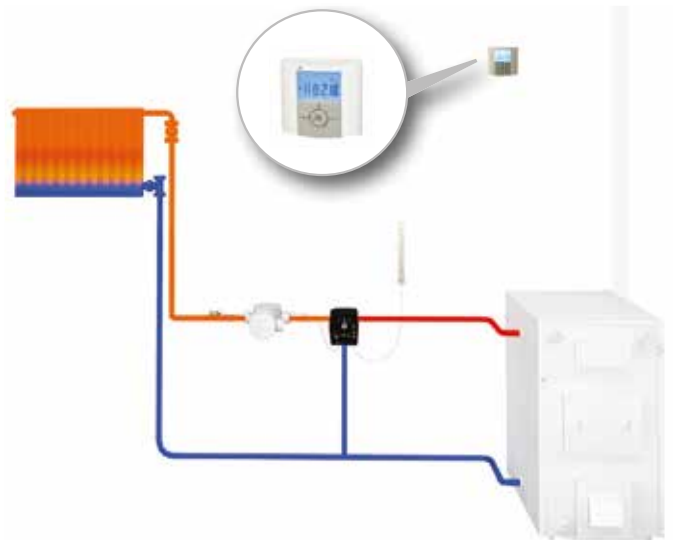

LK 130 - WEATHER COMPENSATED INDOOR TEMPERATURE CONTROLLER

LK 130 SmartComfort is an electronic, weather compensated, indoor temperature controller for hydronic radiator and underfloor heating systems. By measuring the supply, outdoor and indoor temperatures LK 130 SmartComfort regulates the mixing valve to provide the system with the exact amount of heat required in the building at any given time. The supply temperature can be limited with a minimum and a maximum value. LK 130 SmartComfort is delivered with a room temperature unit allowing easy setting of the desired indoor temperature.

LK 130 - ITEMS INCLUDED

- Temperature controller
- Adapter 24 VDC
- Mounting kit for mixing valve
- Supply temperature sensor with 1 m cable
- Outdoor temperature sensor with 15 m cable and protective casing
- Room temperature unit SmartComfort RT with 15 m cable or Room temperature unit SmartComfort RTW with wireless receiver



LK 130 SMARTCOMFORT

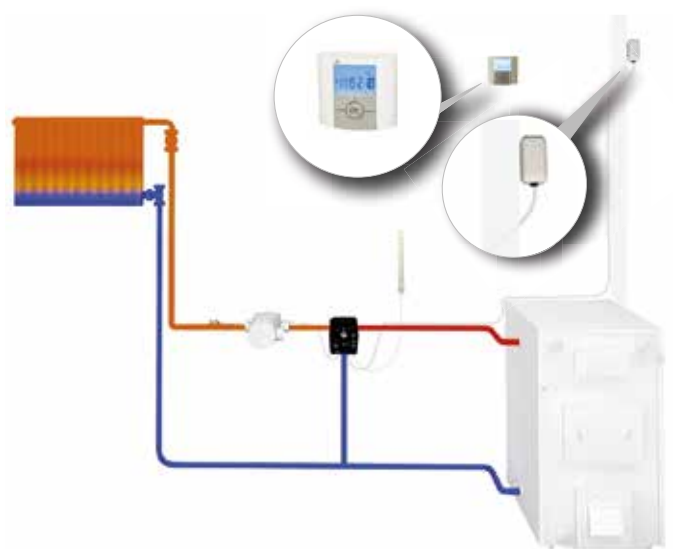

PUMP CONTROL - SmartComfort PC

For further energy saving a pump control, SmartComfort PC, can easily be connected to the controller - see under Accessories. SmartComfort PC stops the circulating pump when no heat is required and exercises pump every two days, thus eliminating the risk of pump stalling after an intermission.

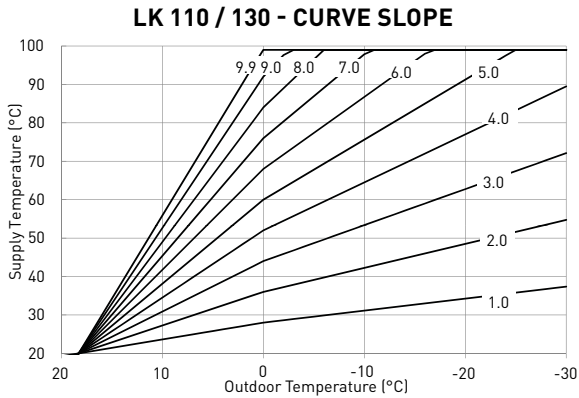

Dependent on the dimension of the heating system and the insulation of the building, the heating curve may need to be adjusted in order to achieve the desired room temperature. The curve slope and the parallel displacement are easily adjusted with the push buttons.

LK 120/130 DISPLAY - ROOM TEMPERATURE UNIT

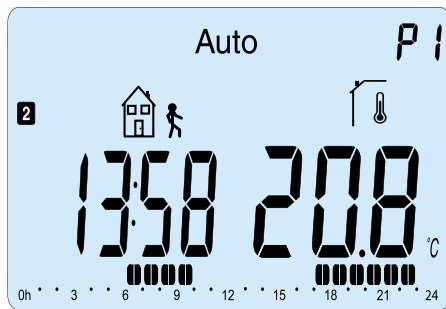

LK ROOM TEMPERATURE UNIT

The room temperature unit is available in two versions; with fixed cable SmartComfort RT or wireless receiver SmartComfort RTW.

The room temperature unit is equipped with a connection port for external control, such as via a GSM modem, making it possible to activate a preset temperature change via mobile phone.

For further energy saving and increased comfort there are nine preset programs with scheduled temperature changes. You can also create your own programs. Additional functions such as holiday and timer settings are available. The current outdoor temperature can be read on the room temperature unit.

After a temperature setback the room temperature unit applies a booster function which briefly increases the supply temperature in order to quickly reach the desired room temperature. Should the room temperature unit sense a sudden change in temperature, such as when airing a room, the unit disregards this change for the following half hour.

LK 130 SMARTCOMFORT

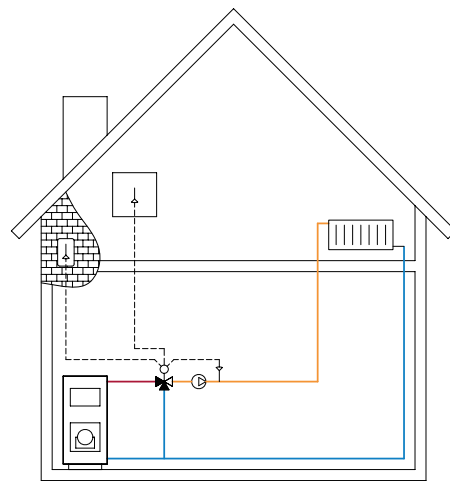

LK 100 SmartComfort CT

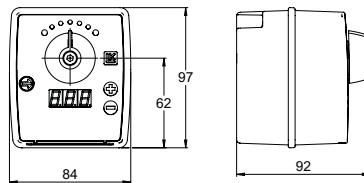

Article no.	Type	Weight kg
181242	LK 100 SmartComfort CT - EU	0.5
181248	LK 100 SmartComfort CT - UK	0.5
181249	LK 100 SmartComfort CT - US	0.5

LK 110 SmartComfort

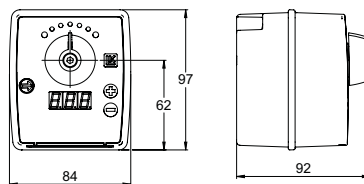

Article no.	Type	Weight kg
181243	LK 110 SmartComfort - EU	0.7
181250	LK 110 SmartComfort - UK	0.7
181251	LK 110 SmartComfort - US	0.7

LK 120 SmartComfort

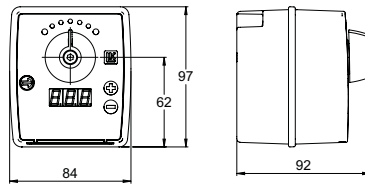

Article no.	Type	Weight kg
181244	LK 120 SmartComfort - EU, with room temperature unit SmartComfort RT - 15 m cable	0.8
181245	LK 120 SmartComfort - EU, with room temperature unit SmartComfort RTW - wireless receiver	0.7
181252	LK 120 SmartComfort - UK, with room temperature unit SmartComfort RT - 15 m cable	0.8
181254	LK 120 SmartComfort - UK, with room temperature unit SmartComfort RTW - wireless receiver	0.7
181253	LK 120 SmartComfort - US, with room temperature unit SmartComfort RT - 15 m cable	0.8

LK 130 SmartComfort

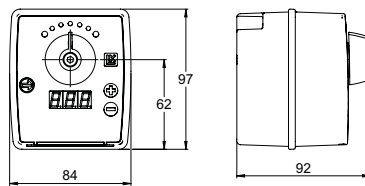

Article no.	Type	Weight kg
181246	LK 130 SmartComfort - EU, with room temperature unit SmartComfort RT - 15 m cable	1.0
181247	LK 130 SmartComfort - EU, with room temperature unit SmartComfort RTW - wireless receiver	0.9
181256	LK 130 SmartComfort - UK, with room temperature unit SmartComfort RT - 15 m cable	1.0
181258	LK 130 SmartComfort - UK, with room temperature unit SmartComfort RTW - wireless receiver	0.9
181257	LK 130 SmartComfort - US, with room temperature unit SmartComfort RT - 15 m cable	1.0

SPARE PARTS AND ACCESSORIES



Article no.	Article	Position
187098	Temperature controller SmartComfort CT	1
187099	Temperature controller SmartComfort	1
025010	Adapter 24 VDC - EU	2
025011	Adapter 24 VDC - UK	2
025012	Adapter 24 VDC - US	2
181260	Mounting kit LK	3
025013	Supply temperature sensor, 1 m cable	4
025014	Outdoor temperature sensor, 15 m cable	5
025020	Protective casing for outdoor temperature sensor	6
187096	Room temperature unit SmartComfort RT	7
025025	Cable for SmartComfort RT, 15 m	8
025026	Extension cable for SmartComfort RT, 15 m	9
187113	Room temperature unit SmartComfort RTW with wireless receiver	10
187095	Pump control SmartComfort PC	11
025027	Extension cable for outdoor temperature sensor, 15 m	12
025008	Extension cable for adapter, 1 m	13

Valve Actuator

LK 941 EasyMix



TECHNICAL DATA

Voltage	230 VAC 50 Hz 24 VAC 50 Hz
Power consumption	6 VA
Angle of rotation	90° electrically limited
Torque	15 Nm
Operation time	73 s/147 s
Ambient temperature	Min. 0 °C/Max. 55 °C
Position indication	Reversible scale
Direction of operation	Selectable
Manual override	Disengagement of gears
Protection type	IP 44
Protection class	II
Electrical connection	Cable 1 m
Signal connector	3-point SPDT 0-10 VDC/4-20 mA



LK 941 EasyMix is a series of valve actuators. Depending on model the actuator can be operated by a controller with a 3-point SPDT output or a proportional 0-10 V / 4-20 mA output. The angle of rotation is electrically limited to 90°.

The actuator can be mounted in any position except below the valve. The actuator is mounted directly onto the valve spindle with a screw. An anti-rotation bolt keeps the actuator in position. When needed, the actuator can be put into manual mode by pressing and turning the button on the housing cover 90° to disengage the gears. The actuator can now be put in any position by turning the handle on the front. The position is indicated on the reversible scale.

LK 941 EasyMix fits most mixing valves on the market.

LK 941

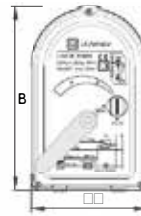
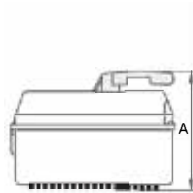

Article no.	Connection	Voltage	Torque	Operation time	A mm	B mm	C mm	Weight kg
066129	1 m cable	230 VAC	15 Nm	73 s	92.5	125	78	0.6
066132	1 m cable	230 VAC	15 Nm	147 s	92.5	125	78	0.6
066133	1 m cable. 0 - 10 VDC	24 VDC/AC	15 Nm	73 s	92.5	125	78	0.6

Valve Actuator

LK 950 Valve Actuator

- Up to 10 Nm
- Wide range of products



TECHNICAL DATA

Voltage	230 VAC 50/60 Hz 24 VAC 50/60 Hz, 24 VDC/AC 50/60 Hz
Power consumption	1.5 - 3.5 W
Dimensioning*	1.5 - 3.5 VA
Angle of rotation	90°, electrically limited
Torque	5/10 Nm
Operation time	70/140/280 s
Ambient temperature	Min. 0 °C/Max. 50 °C
Position indication	Reversible scale
Direction of operation	Selectable
Manual override	Disengagement of gears
Protection type	IP 40
Protection class	II (Double Insulated) III (SELV)
Electrical connection	Cable 1.5 m, 3 x 0.75 mm ²



LK 950 is a series of valve actuators. Depending on model the actuator can be operated by a controller with a 3-point SPDT output or a proportional 2 (0) - 10 V output. The actuator is fitted with limit switches. The angle of rotation is electrically limited to 90°. An additional auxiliary adjustable switch can be ordered as an accessory.

The actuator can be mounted in any position except below the valve. The actuator is mounted directly onto the valve spindle with a screw. An anti-rotation bolt keeps the actuator in position. When needed, the actuator can be put into manual mode by turning the button on the housing cover 90° clockwise to disengage the gears. The actuator can now be put in any position by turning the handle on the front. The position is indicated on the reversible scale.

LK 950 fits most mixing valves. Mounting kits for mixing valves of other brands are available - please see the product sheet for Mounting Kits.

* Depending on model

LK 950

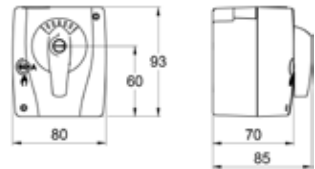

Article no.	Voltage	Torque	Operation time	Note	Weight kg
180742	24 VAC	5 Nm	70 s	Mounting kit is not included	0.5
180744	24 VAC	5 Nm	140 s	Mounting kit is not included	0.5
50801007	230 VAC	5 Nm	35 s	1.5 m cable	0.5
180756	230 VAC	5 Nm	70 s	1.5 m cable	0.5
180759	230 VAC	5 Nm	140 s	1.5 m cable	0.5
180760	230 VAC	5 Nm	140 s	3 m cable	0.5
180762	230 VAC	10 Nm	280 s	1.5 m cable	0.5
180764	230 VAC	10 Nm	140 s	1.5 m cable	0.5
181208	230 VAC	5 Nm	140 s	incl. auxiliary switch	0.5
180978	230 VAC	5 Nm	280 s	1.5 m cable	0.5
180765	24 VDC/AC	5 Nm	70 s	2 (0) - 10 V, without cable	0.5
182323	24 VDC/AC	5 Nm	70 s	2 (0) - 10 V, 3 m cable	0.5

SPARE PARTS AND ACCESSORIES



Article no.	Article	Position
180739	Mounting kit 950	1
180741	Auxiliary switch 950	2
026223	Cable for auxiliary switch, 1.5 m	3

Mounting Kits

Mounting Kits



Mounting kits for mixing valves of other brands



Article no.	Type	Valve brand
187086	440, 450, 451, 460, 475, 476, W28	Barberi
187084	DR-GMLA, DR-GFLA (DN 15-35)	Centra
187087	DR-MA (DN 15-50)	Centra
180746		Danfoss
180403	VRG, VRB (DN 15-50)	ESBE
187088	BR80 SMD/SMV	Holter
187094	SERIES 2, VCI 31 (DN 20-40)	Landis & Staefa
187089	SERIES 1, B3F (DN 20-40)	Landis & Staefa
187090		Lazzari
187091	3W, 4W	Lovato
187092	MB	Satchwell
187093	MBF	Satchwell
180747		Siemens
180740	3W, 4W, H	Wita / Oventrop / Meibes

Differential Temperature Controllers



LK 160 SmartBio® is an electronic differential temperature controller that offers preset hydraulic systems for optimal heating in systems with storage tanks. The backlit color display provides clear insight into your system's operation, while user-friendly controls simplify adjustments. It can manage pumps and also trigger an immersion heater or burner when needed, ensuring consistent comfort.

Differential Temperature Controller

LK 150 SmartSol

- Colour display
- Frost protection



TECHNICAL DATA

Voltage	230 VAC, 50 Hz
Power consumption	3.5 VA
Protection type	IP 20
Protection class	II
Display	TFT backlit colour display 47 x 35 mm
Triac outputs	230 VAC \pm 10%, 1 A, 200 VA
Relay output	Max. 240 VAC, 4 A
Sensors	PT 1000
High-efficiency pump	Analog output 0 - 10 V, max. 10 mA PWM output 100 Hz - 2 kHz



ITEMS INCLUDED IN ARTICLE NO. 181796

- Differential temperature controller LK 150 SmartSol Top
- Collector sensor PT 1000 - 3 m cable
- Three tank sensors PT 1000 - 4 m cable

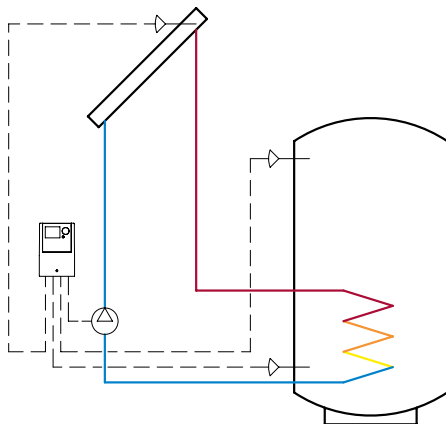

LK 150 SmartSol is an electronic differential temperature controller for solar heating systems. The controller has, depending on model, 20 or 24 preset hydraulic systems for different solar heating systems. The chosen hydraulic system and operating status is shown on the backlit colour display. Controls and settings are easily carried out using the rotating knob and the esc-button. LK 150 SmartSol can handle high efficiency pumps.

FEATURES, MODEL "TOP"

- Two speed controlled outputs for circulating pumps or valves
- Output for high efficiency pump
- Floating relay output
- Operation time counter for relay outputs
- Pump exercise
- Balancing of sensors
- Overheating protection for collectors and tanks
- Collector and tank cooling
- Anti-freeze
- Collector defrosting
- Tube collector function
- Additional heat
- Quick-charging
- Holiday function
- Integrated energy measuring
- Integrated clock with date
- Automatic summer/winter time
- Graphic, multilingual colour display
- Self-explanatory menu and user guide
- SD card slot for data logging (micro SD)
- One input for analog vortex flow sensor
- 24 hydraulic systems
- Terminal block for six PT 1000 sensors

LK 150 SmartSol

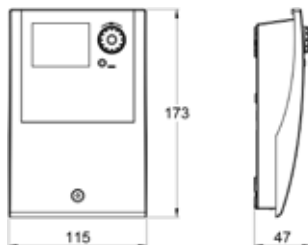

Article no.	Type	Weight kg
181796	150 SmartSol Top	0.7

SPARE PARTS AND ACCESSORIES



Article no.	Article	Position
025042	Differential temperature controller SmartSol Top	1
181187	Collector sensor PT 1000 Ø 5 mm - 3 m cable	2
181186	Tank sensor PT 1000 Ø 6 mm - 4 m cable	3
180812	Sensor pocket 150 mm	4

Differential Temperature Controller

LK 160 SmartBio®



- With SmartBio you can optimize the energy efficiency, and have more environmentally friendly biomass fuel solution

TECHNICAL DATA

Voltage	230 VAC, 50 Hz
Power consumption	3.5 VA
Protection type	IP 20
Protection class	II
Display	TFT backlit colour display 47 x 35 mm
Triac outputs	230 VAC ± 10%, 1 A, 200 VA
Relay output	Max. 240 VAC, 4 A
Sensors	PT 1000
High-efficiency pump	Analog output 0 -10 V, max. 10 mA PWM output 100 Hz - 2 kHz



LK 160 SmartBio® is an electronic differential temperature controller with several preset hydraulic systems for energy efficiency in heating systems with storage tanks. The chosen hydraulic system and operation status is shown on the backlit colour display. Controls and settings are easily carried out using the rotating knob and the esc-button. LK 160 SmartBio® can handle high efficiency pumps.

LK 160 SmartBio® can also activate an immersion heater or burner if the temperature in the primary tank falls below the selected value. The additional heat has a sophisticated delay function that further adds to the efficiency of the system.

FEATURES

- Several hydraulic systems
- Two outputs for circulating pumps
- Pump exercise
- Floating relay output
- Sensor balancing
- Adjustable delay function for additional heat
- Graphic, multilingual colour display with time and date
- User-friendly menu system
- SD card slot for data logging (micro SD)
- Speed control possible for two circulation pumps via PWM signal

HYDRAULIC SYSTEM 1

Hydraulic system 1 is intended for storage tank systems with a primary and secondary tank. LK 160 SmartBio® controls the two circulating pumps between the tanks. When the primary tank is fully charged the charge pump starts at the chosen temperature to fill the secondary tank. When the temperature in the primary tank falls, the recharging pump starts and transfers energy back to the primary tank.

HYDRAULIC SYSTEM 1.1

In order to prevent self-circulation in both directions LK 970 ThermoBac DB double acting check valve should be mounted between the circulating pumps - see under spare parts and accessories.

HYDRAULIC SYSTEM 1.2

Hydraulic System 1.2: The LK 824 ThermoVar® is a thermic valve with double acting check valve function which ensures a high return temperature to the solid fuel boiler, thus increasing the efficiency of the system – see spare parts and accessories.

HYDRAULIC SYSTEM 2

Hydraulic system 2 is intended for storage tank systems in which heating water and domestic hot water are taken from a secondary tank. Heat is to be transferred from the main tank to the secondary tank. By measuring the temperature difference between the tanks LK 160 SmartBio® controls the charge pump.

HYDRAULIC SYSTEM 3

Hydraulic system 3 is intended for the charging of a storage tank with a pellet, oil or gas fired burner. By measuring the temperatures in the tank and boiler LK 160 SmartBio® controls the burner and charge pump.

HYDRAULIC SYSTEM 4

Hydraulic system 4 is intended for storage tank systems with domestic hot water tanks. This system gives priority to the heat in the upper part of the main tank. This enables a fast transfer of heat to the domestic hot water tank. LK 160 SmartBio® controls the charge pump to the domestic hot water tank, the zone valve of the main tank and the circulator in the heating loop.

STANDARD KIT

- Differential temperature controller LK 160 SmartBio®
- Three sensors PT 1000 - 4 m cable



KIT FOR HYDRAULIC SYSTEM 1.1

- Differential temperature controller LK 160 SmartBio®
- Three sensors PT 1000 - 4 m cable
- Two circulating pumps Grundfos Alpha1 25-60/130
- Two ball valves 1"
- Check valve with double acting flow LK 970 ThermoBac DB
- Four gaskets EPDM



HYDRAULIC SYSTEM 1.1

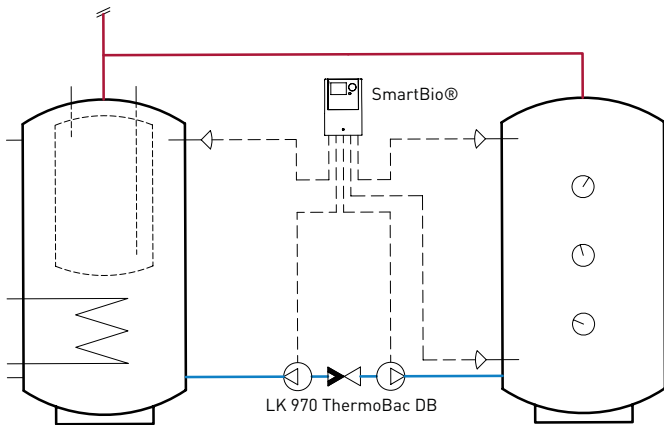

HYDRAULIC SYSTEM 1.2

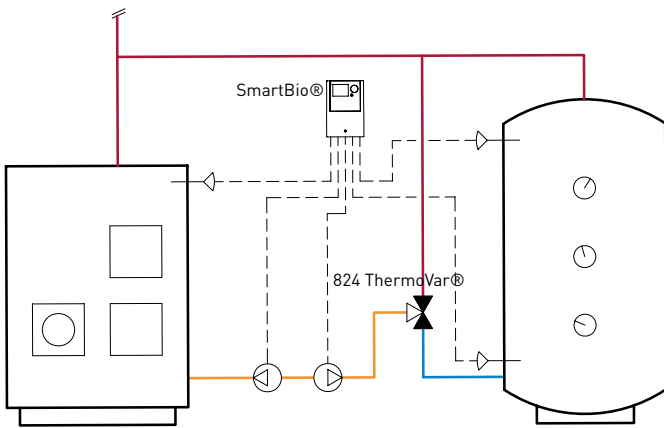

HYDRAULIC SYSTEM 3

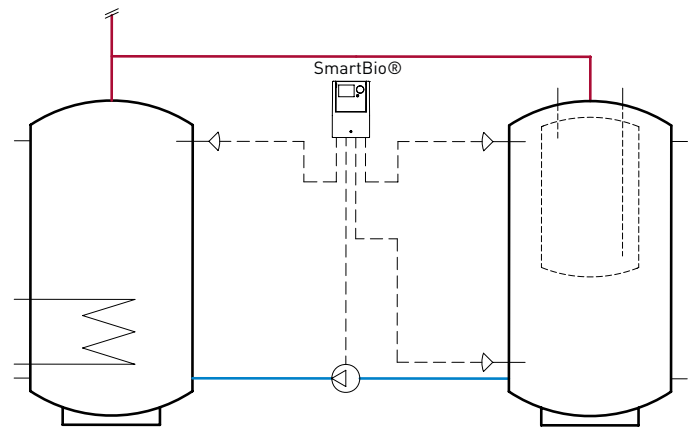

HYDRAULIC SYSTEM 2

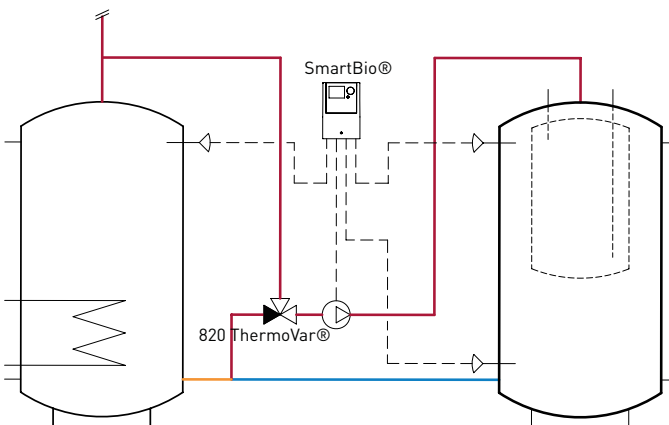

HYDRAULIC SYSTEM 4

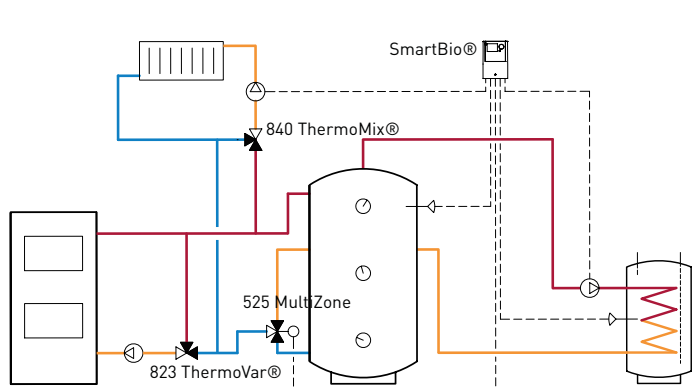

LK 160 SmartBio®

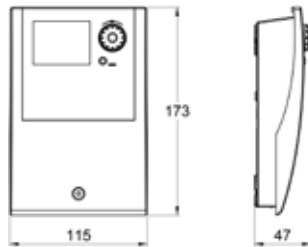

Article no.	Type	Weight kg
181234	LK 160 SmartBio standard kit	0.7
181233	LK 160 SmartBio® kit for hydraulic system 1	6.2

SPARE PARTS AND ACCESSORIES



Article no.	Article	Position
025017	Differential temperature controller SmartBio®	1
181186	Tank sensor PT 1000 Ø 6 mm - 4 m cable	2
187129	Circulating pump Grundfos Alpha1 25-60/130	3
187017	Ball valve F 1"	4
187018	Ball valve F 1¼"	5
187019	Ball valve 28 mm	6
180487	Check valve with double acting flow LK 970 ThermoBac DB	7
180812	Sensor pocket 150 mm	8
013025	Gasket EPDM 1½" - Ø44 x Ø27 x 2 mm	9
181553	LK 824 ThermoVar® M 1½", 45 °C	10
181554	LK 824 ThermoVar® M 1½", 55 °C	10
181555	LK 824 ThermoVar® M 1½", 61 °C	10
181556	LK 824 ThermoVar® M 1½", 66 °C	10
181557	LK 824 ThermoVar® M 1½", 72 °C	10
180810	Connection M 1½" x M 1½", L30 mm	11

Differential Temperature Controller

LK 162 SmartStove®



- With the alarm function in case of over temperature, you can enjoy the warmth without worrying

TECHNICAL DATA

Voltage	230 VAC, 50 Hz
Power consumption	3,5 VA
Protection type	IP 20
Protection class	II
Display	TFT backlit colour display, 47 x 35 mm
Triac outputs	230 VAC ± 10%, 1 A, 200 VA
Relay output	Max. 240 VAC, 4 A
Sensors	PT 1000
High-efficiency pump	Analog output 0 -10 V, max. 10 mA PWM output 100 Hz - 2 kHz



LK 162 SmartStove® is a biomass controller for multi-fuel water containing stoves with buffer tanks. The controller has a number of preset hydraulic systems for different installations.

For indication of the active hydraulic system and the current temperatures in stove and buffer tank the controller is equipped with a coloured full graphics display which is permanently backlit.

LK 162 SmartStove® can control the charge pump of a loading unit, the circulator in a heating loop, high-efficiency pumps and an additional heat source.

FEATURES

- Acoustic alarm and indication in the display if over temperature should occur in stove or buffer tank
- A temperature sensor in the stove controls the charge pump of the loading unit which means that no fluegas thermostat is needed
- Pump delay function. The charge pump in the loading unit does not start until the stove has reached a certain temperature. This saves energy, prevents tarring and considerably prolongs the life-time of the stove
- Dynamic pump control can be activated when the loading unit is equipped with a speed-controlled pump. The pumpcontrol keeps the flow at a constant temperature
- Economy or comfort mode can be selected to optimize energy efficiency in the potable hot water boiler and/or in the heating system
- Controls an additional heat source
- Delay function for the additional heat source
- 7 hydraulic systems which can be mirrored
- 2 outputs for speed-controlled pumps with PWM and/ or analogue signal
- 6 terminals for temperature sensors
- 1 floating change-over contact
- SD card slot for data logging and software update
- Legionella prevention
- Pump exercise
- Freeze protection

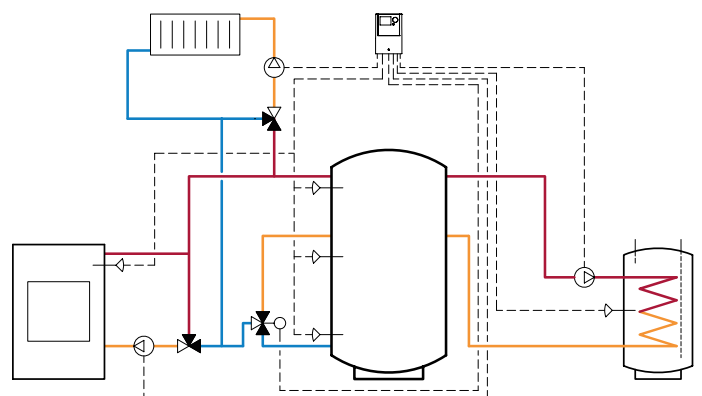
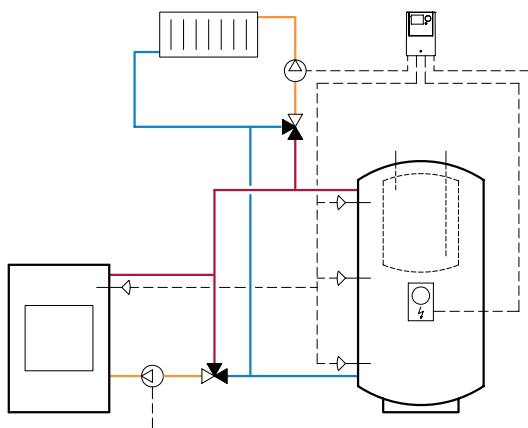

LK 162 SmartStove®

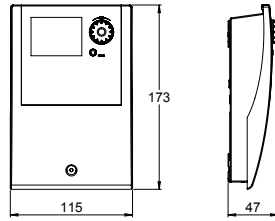

Article no.	Type	Weight kg
181708	LK 162 SmartStove®	0.7

Four sensors included (PT 1000 - 4 m cable).

SPARE PARTS AND ACCESSORIES



Article no.	Article	Position
181186	Tank sensor PT 1000 Ø 6 mm - 4 m cable	1
180812	Sensor pocket 150 mm	2

Zone Valves

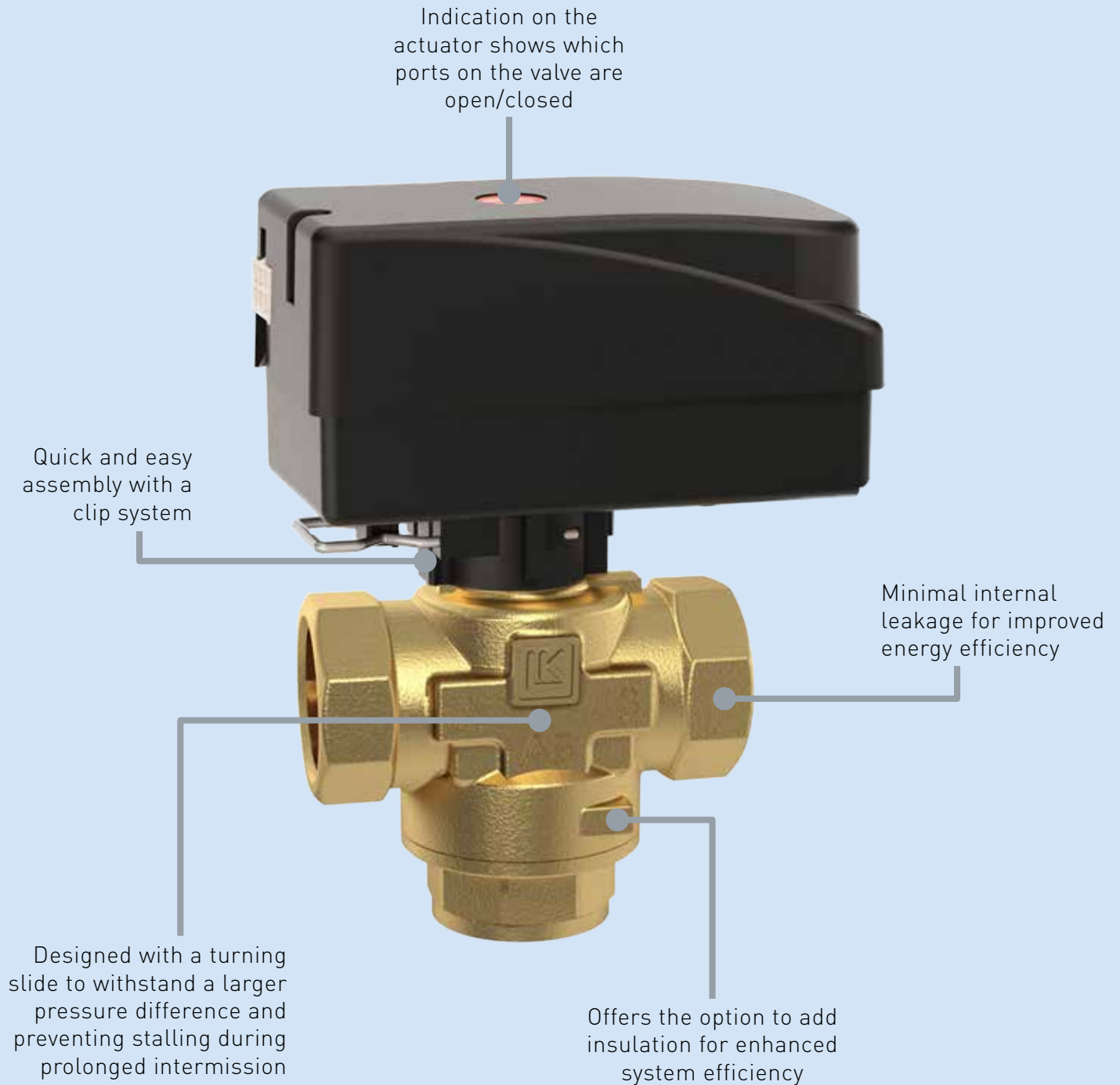

LK 525 MultiZone 3W is a motorized 3-way zone valve with a unique turning slide which allows it to withstand a larger pressure difference and reduces the risk of it stalling after a long intermission. This makes it especially suited for heat pump applications where there can be long intermissions between the changes to the direction of the flow during the warm season. Plus, its minimal internal leakage and quick clip system assembly make it a reliable choice for precise On/Off control.

Design your own zone valve



Cable
Molex®
24 VAC
230 VAC

Actuator,
60° angle of rotation

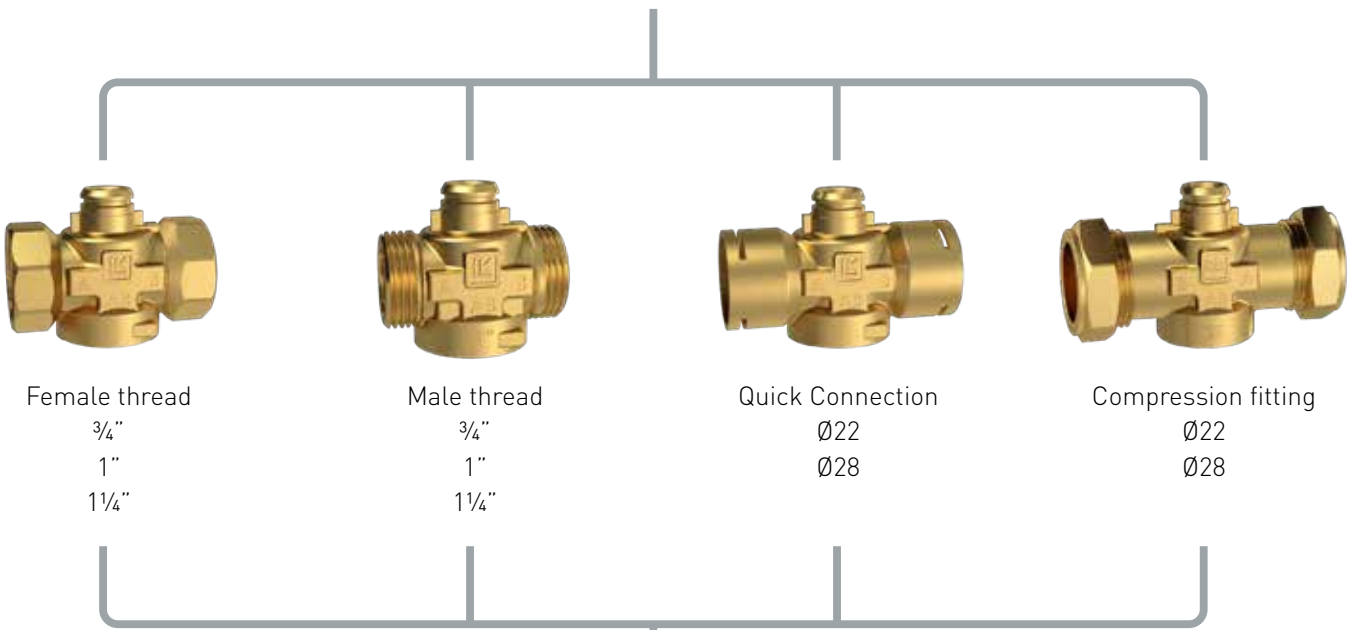

3-Way

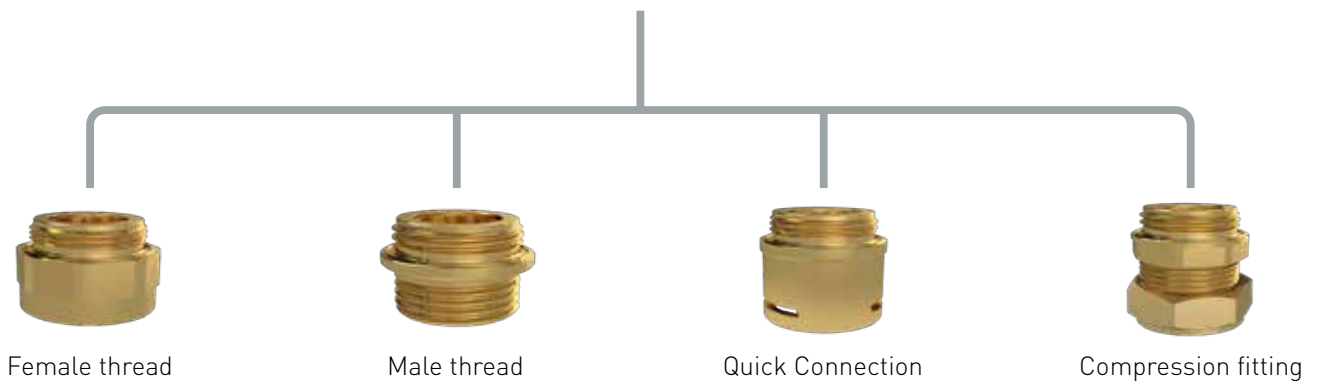

For more information please contact our Sales Department.

Design your own valve



Cable
24 VAC
230 VAC

Actuator,
90° angle of rotation



Female thread
3/4"
1"
1 1/4"



Male thread
3/4"
1"
1 1/4"



Quick Connection
Ø22
Ø28



Compression fitting
Ø22
Ø28



2-Way



3-Way regulating
Kvs 4



3-Way regulating
Kvs 8



2-Way



Female thread



Male thread



Quick Connection



Compression fitting



Connect quickly and securely

Quick connection solutions save assembly time and ensure correct installation – every time.

To meet a growing trend for products that can be installed quickly and easily, we have developed a quick-connection solution.

A specially designed end form with two O-rings to seal the joint between the two elements. By using double O-rings, we create a more secure, guaranteed sealed connection. The pipe is held in place in the valve by a locking pin.

End forming can be performed on copper or stainless steel pipes with dimensions \varnothing 22 mm and \varnothing 28 mm

END FORMING FOR DOUBLE O-RINGS TAKES INSTALLATION TO A NEW LEVEL

- Quick installation
- Exactly the same assembly procedure every time
- Allows for any tolerances
- Double O-rings for a guaranteed sealed connection



Double O-rings for guaranteed sealed connections that allow for tolerances.

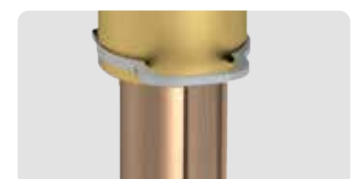

Quick and secure fastening with locking pin

Zone Valves

LK 525 MultiZone 2W

- Simple and flexible assembly with clip system
- Actuators are available as normally closed (NC) or normally open (NO). Direction is displayed on the actuator



TECHNICAL DATA

Angle of rotation	90°/360°
Leakage	< 0.1% of Kvs at 100 kPa
Operation time	12 seconds (90°)
Max. working pressure	1.0 MPa (10 bar)
Max. differential pressure	100 kPa (1 bar)
Working temperature	Min. 5 °C/Max. 80 °C (90 °C briefly)
Ambient temperature	Min. 1 °C/Max. 60 °C
Thread standard	Rp - female thread, G - male thread, ISO 228/1
Protection class	IP 44
Media	Water - Glycol mixture max. 50% Ethanol mixture max. 30%
Electrical connection	Fixed wire
Signal connector	Single pole SPST
Cable specification	Dimension 3 x 0,75 mm ²
Wire colours	Blue, brown, black
External insulation	PVC
Actuator	7 VA, 230 VAC, 50 Hz
Material, valve body	Brass EN 12165 CW617N
Material, external cover	Brass EN 12164 CW614N
Material, slide/spindle	PPS Composite
	Actuator only



LK 525 MultiZone is a motorized 2-way zone valve for application in heating systems in which the flow through one or more zones is to be controlled. The zone valve has On/Off control and is designed with a turning slide which allows it to withstand a larger pressure difference and reduces the risk of it stalling after a long intermission. On the upper surface of the actuator is an indicator that shows which port is open or closed.

The zone valve must not be installed with the motor underneath the valve unit.

In case of a power failure, the valve cone stays in its current position. When the power is switched off, the valve can be manually set. Remove the motor and turn the spindle to your selected position. When the power is restored, turn the valve back to its original position and reinstall the motor.

Please note that the motor can be installed in only one position.

The valve requires no maintenance but the installation should be checked regularly.

CAPACITY DIAGRAM

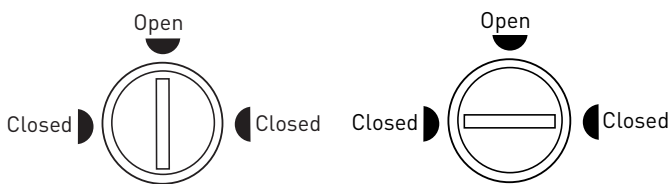
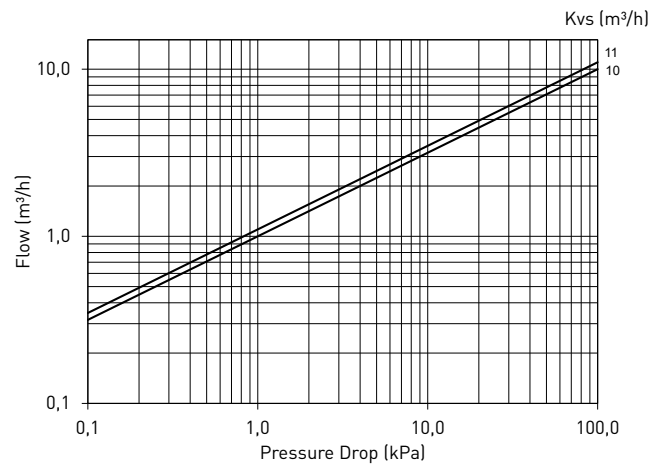

WIRING DIAGRAM

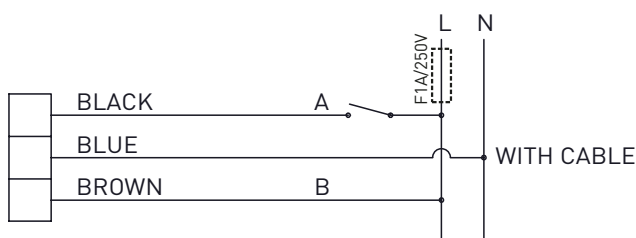

Valve and motor are available in closed or open position. (NC; Normally-Closed or NO; Normally Open)

WIRING DIAGRAM

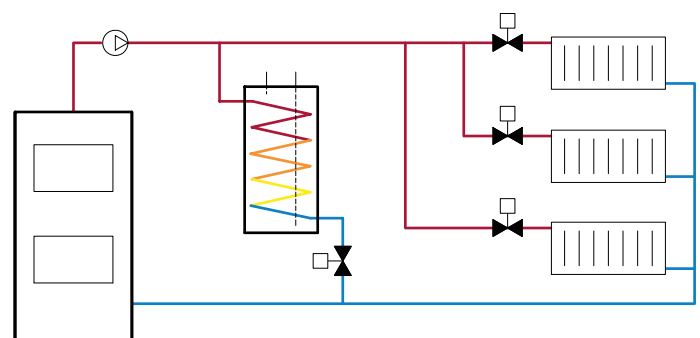

LK 525 2W - Female thread

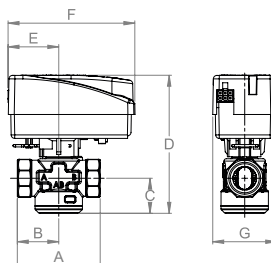

Article no.	Type	Dim.	Kvs m ³ /h	A mm	B mm	C mm	D mm	E mm	F mm	G mm	Weight kg
066246	NO	F 3/4"	10.0	70	35	30	118	43	107	54	0.2
066247	NO	F 1"	11.0	74	37	30	118	43	107	54	0.3
066248	NO	F 1 1/4"	11.0	84	42	30	118	43	107	54	0.6
066423	NC	F 3/4"	10.0	70	35	30	118	43	107	54	0.2
066424	NC	F 1"	11.0	74	37	30	118	43	107	54	0.3
066425	NC	F 1 1/4"	11.0	84	42	30	118	43	107	54	0.6

LK 525 2W - Male thread

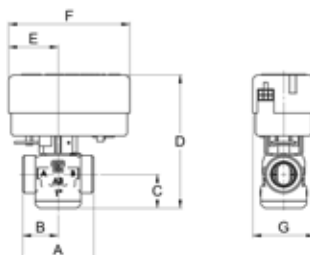

Article no.	Type	Dim.	Kvs m ³ /h	A mm	B mm	C mm	D mm	E mm	F mm	G mm	Weight kg
066112	NC	M 3/4"	10.0	70	35	30	118	43	107	54	0.2
066102	NC	M 1"	11.0	62	31	30	118	43	107	54	0.3
066103	NC	M 1 1/4"	11.0	74	37	30	118	43	107	54	0.6
066115	NO	M 3/4"	10.0	70	35	30	118	43	107	54	0.2
066113	NO	M 1"	11.0	62	31	30	118	43	107	54	0.3
066114	NO	M 1 1/4"	11.0	74	37	30	118	43	107	54	0.6

LK 525 2W - Compression fitting

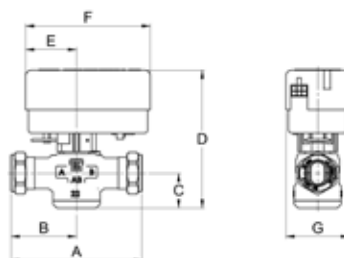

Article no.	Type	Dim.	Kvs m ³ /h	A mm	B mm	C mm	D mm	E mm	F mm	G mm	Weight kg
066104	NC	22 mm	11.0	110	55	30	118	43	107	54	0.4
066105	NC	28 mm	11.0	110	55	30	118	43	107	54	0.6
066116	NO	22 mm	11.0	110	55	30	118	43	107	54	0.4
066119	NO	28 mm	11.0	110	55	30	118	43	107	54	0.6

LK 525 - Actuator

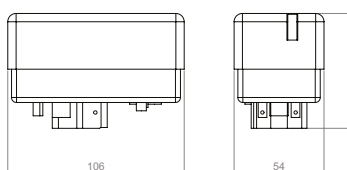

Article no.	Type	Connection	Torque	Weight kg
066111	NC	EMV 110-K SPST Actuator 230 VAC, Cable 1 m	5 Nm	0.3
066199	NO	EMV 110-K SPST Actuator 230 VAC, Cable 1 m	5 Nm	0.3

LK 525 2W SET – incl. Actuator 230VAC 1m Cable - Female thread

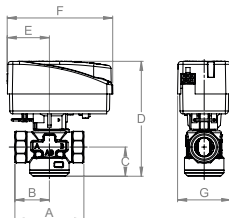

Article no.	Dim.	Kvs m ³ /h	Torque	A mm	B mm	C mm	D mm	E mm	F mm	G mm	Weight kg
066442	F 3/4"	10.0	5 Nm	70	35	30	118	43	107	54	0.5
066443	F 1"	11.0	5 Nm	62	31	30	118	43	107	54	0.6
066444	F 1 1/4"	11.0	5 Nm	74	37	30	118	43	107	54	0.9

LK 525 2W SET – incl. Actuator 230VAC 1m Cable - Male thread

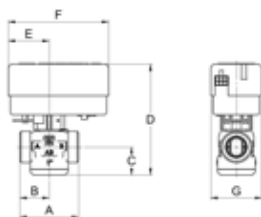

Article no.	Dim.	Kvs m ³ /h	Torque	A mm	B mm	C mm	D mm	E mm	F mm	G mm	Weight kg
066437	M 3/4"	10.0	5 Nm	70	35	30	118	43	107	54	0.5
066438	M 1"	11.0	5 Nm	62	31	30	118	43	107	54	0.6
066439	M 1 1/4"	11.0	5 Nm	70	35	30	118	43	107	54	0.9

LK 525 2W SET – incl. Motor 230VAC 1m Cable - Compression fitting

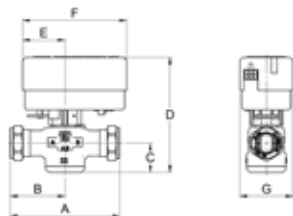

Article no.	Dim.	Kvs m ³ /h	Torque	A mm	B mm	C mm	D mm	E mm	F mm	G mm	Weight kg
066440	22 mm	11.0	5 Nm	110	55	30	118	43	107	54	0.7
066441	28 mm	11.0	5 Nm	110	55	30	118	43	107	54	0.9

Mixing / Diverting Valve

LK 525 MultiZone 3R

- Minimal internal leakage
- The slide is designed to provide accurate regulation at low flows
- Click system for actuator



TECHNICAL DATA

Voltage	230 VAC, 50 Hz
Power consumption	5 VA
Angle of rotation	90°
Torque	5 Nm
Leakage	< 0.1% of Kvs at 100 kPa
Operation time	110 s
Max. working pressure	1.0 MPa (10 bar)
Max. differential pressure	100 kPa (1 bar)
Working temperature	Min. 5 °C/Max. 80 °C (90 °C briefly)
Ambient temperature	Min. 5 °C/Max. 55 °C
Manual override	Yes
Thread standard	G - male thread, ISO 228/1
Protection type	IP 44
Protection class	II
Media	Water - Glycol mixture max. 50% Ethanol mixture max. 30%
Electrical connection	Fixed wire
Signal connector	3 point SPDT
Cable specification	3 x 0.75 mm ²
Wire colours	Blue, brown, black
External insulation	PVC
Material, valve body	Brass EN 12165 CW617N
Material, external cover	Brass EN 12164 CW614N
Material, slide/spindle	PPS Composite
	Actuator only



LK 525 MultiZone 3R is a 3-way valve that can be used as a mixing valve or as a diverting valve in heating systems.

The valve is constructed so that the leakage is less than 0.1% of Kvs at 100 kPa. It also has a split linear characteristic which means that the regulation is good even at low flows and capacities.

The valve must not be installed with the motor underneath the valve unit.

Please note that the motor can be installed in only one position.

The motor operates anti clockwise when the black conductor is powered and clockwise when the brown conductor is powered.

The valve requires no maintenance but the installation should be checked regularly.

WIRING DIAGRAM

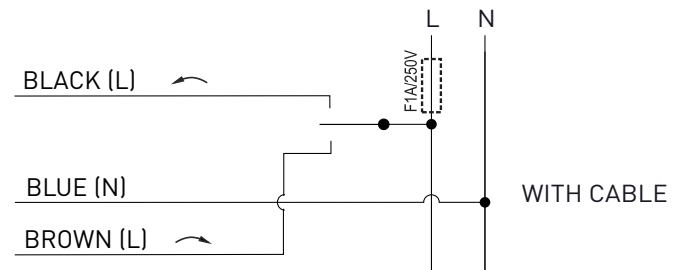

VALVE CHARACTERISTICS

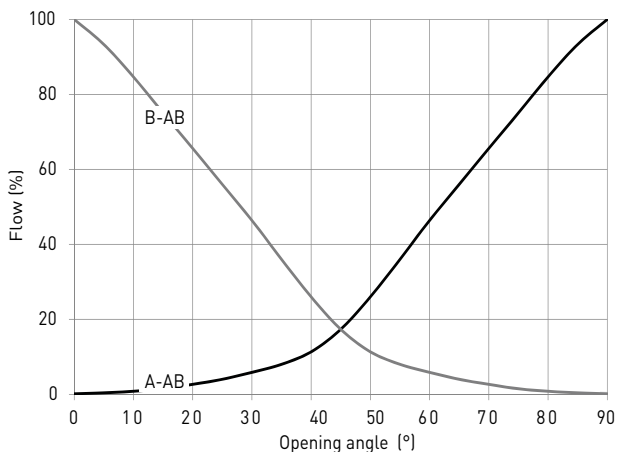

CAPACITY DIAGRAM

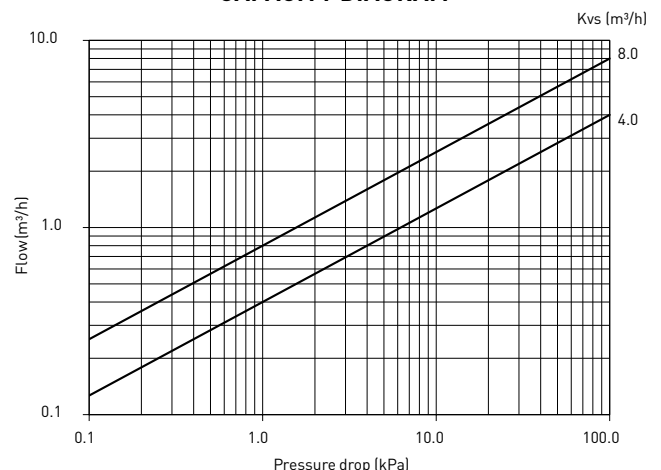

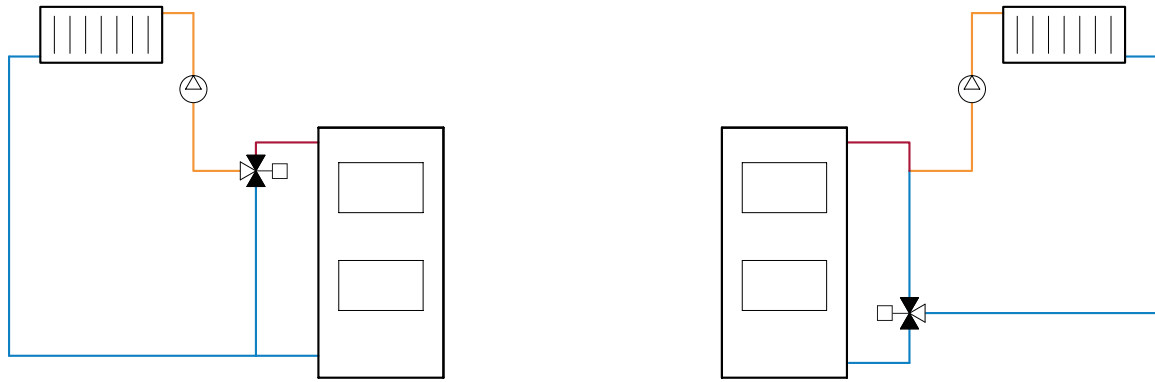

LK 525 3R - Male thread

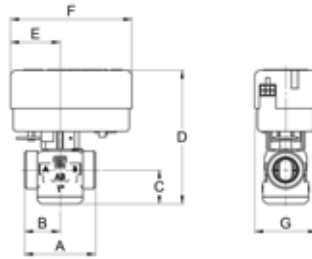

Article no.	Dim.	Kvs m ³ /h	A mm	B mm	C mm	D mm	E mm	F mm	G mm	Weight kg
066077	M 1"	8.0	62	31	39	132	46	109	58	0.3

Other dimensions on request.

LK 525 3R - Compression fitting

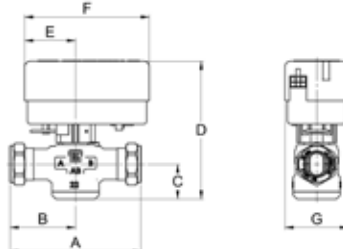

Article no.	Dim.	Kvs m ³ /h	A mm	B mm	C mm	D mm	E mm	F mm	G mm	Weight kg
066079	22 mm	8.0	110	55	50	143	46	109	58	0.4
066080	28 mm	8.0	110	55	54	147	46	109	58	0.6

Other dimensions on request.

LK 940 C

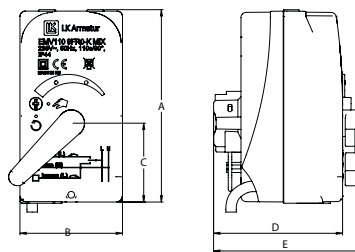

Article no.	Connection	Voltage	Torque	Operation time	A mm	B mm	C mm	D mm	E mm	Weight kg
066127	1 m cable	230 V	5 Nm	110 s*	109	58	45	73	85	0.4
066128	1 m cable 0-10 VDC	24 VAC	5 Nm	110 s*	109	58	45	73	85	0.4

*Other operation times on request.

SPARE PARTS AND ACCESSORIES



Article no.	Article	Position
187202	Insulation	1

Zone Valves

LK 525 MultiZone 3W

- Turning slide to reduce risk of stalling
- Minimal internal leakage
- Quick and easy assembly with clip system



TECHNICAL DATA

Angle of rotation	60°/360°
Leakage	< 0.1% of Kvs at 100 kPa Solar: < 0.5% of Kvs at 100 kPa
Operation time	8 seconds (60°)
Max. working pressure	1.0 MPa (10 bar)
Max. differential pressure	100 kPa (1 bar)
Working temperature	Min. 5 °C/Max. 80 °C (90 °C briefly)
Art.no. 066399, 066418:	Min. 5 °C/Max. 70 °C (80 °C briefly)
Cooling/Heating (inkl. adapter):	Min. -15 °C/Max. 120 °C (160 °C briefly)
Ambient temperature	Min. 1 °C/Max. 60 °C
Thread standard	Rp - female thread, G - male thread, ISO 228/1
Protection class	IP 40 (Molex®) / IP 44 (Cable)
Media	Water - Glycol mixture max. 50% Ethanol mixture max. 30%
Electrical connection	Fixed wire alternatively Molex®-compatible connector
Signal connector	Single pole SPST
Cable specification	Dimension 3 x 0.75 mm ²
Wire colours	Blue, brown, black
External insulation	PVC
Connection	Molex® or Molex®-compatible connector, 6-circuit
Actuator	7 VA, 230 VAC, 50 Hz 7 VA, 24 VAC, 50 Hz
Material, valve body	Brass EN 12165 CW617N
Material, external cover	Brass EN 12164 CW614N
Material, slide/spindle	PPS Composite
	Actuator only



LK 525 MultiZone 3W is a motorized 3-way zone valve for On/Off control. The zone valve is designed with a turning slide which allows it to withstand a larger pressure difference and reduces the risk of it stalling after a long intermission. This makes it especially suited for heat pump applications where there can be long intermissions between the changes to the direction of the flow during the warm season. On the upper surface of the actuator is an indicator that shows which port is open.

Installing the 066177 plastic adapter between the valve unit and the motor protects the motor against condensation, icing and high temperatures.

The zone valve must not be installed with the motor underneath the valve unit.

In case of a power failure, the valve cone stays in its current position. When the power is switched off, the valve can be manually set to the centre position, which distributes the flow between the heating and tap water circuits. Remove the motor and turn the spindle about 30° or turn until hot water flows through both valve ports. When the power is restored, turn the valve back to its original position and reinstall the motor.

Please note that the motor can be installed in only one position.

The valve requires no maintenance but the installation should be checked regularly.

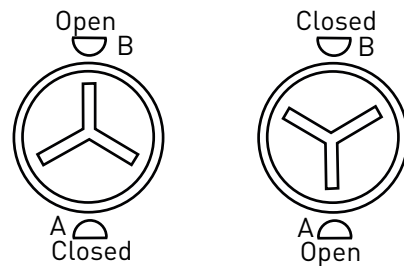

WIRING DIAGRAM

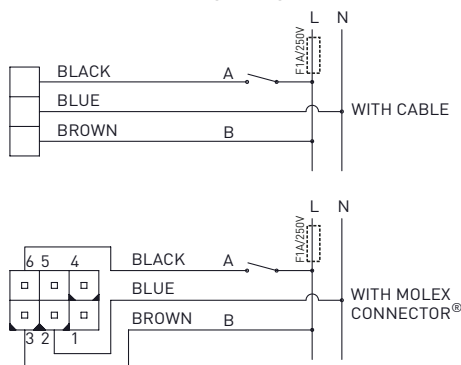

CAPACITY DIAGRAM

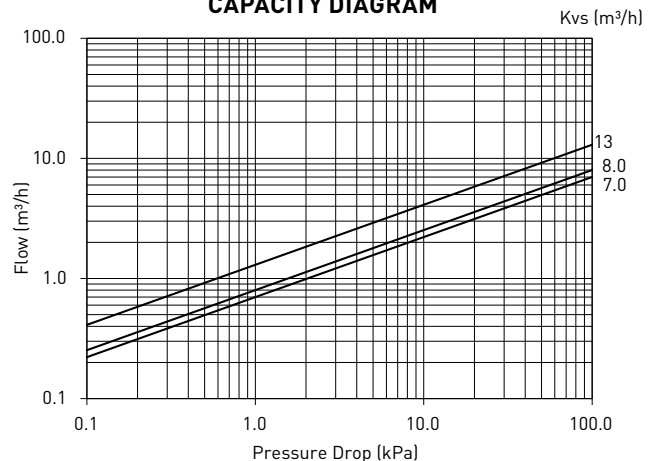

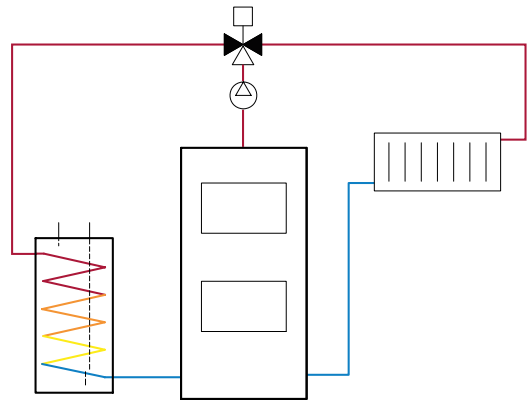
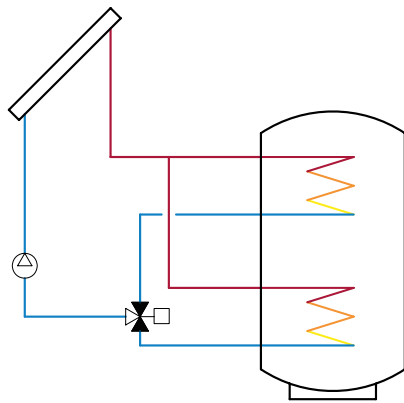

LK 525 3W - Quick Connection

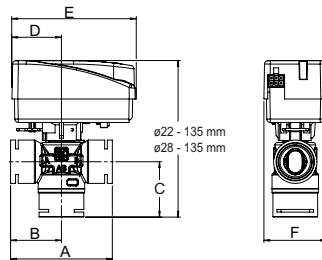

Article no.	Dim.	Kvs m ³ /h	A mm	B mm	C mm	D mm	E mm	F mm	Weight kg
182306	Ø 22	8,0	84	42	46	43	107	54	0.3
182307	Ø 28	8,0	88	44	48	43	107	54	0.5

LK 525 3W - Female thread

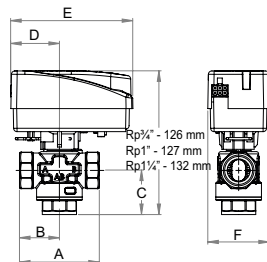

Article no.	Dim.	Kvs m ³ /h	A mm	B mm	C mm	D mm	E mm	F mm	Weight kg
066420	F 3/4"	7,0	70	35	39	43	107	54	0.3
066421	F 1"	8,0	74	37	40	43	107	54	0.3
066422	F 1 1/4"	8,0	84	42	45	43	107	54	0.6

LK 525 3W - Male thread

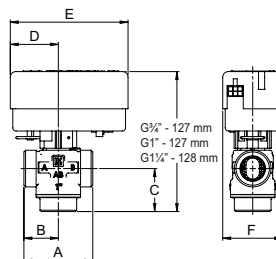

Article no.	Dim.	Kvs m ³ /h	A mm	B mm	C mm	D mm	E mm	F mm	Weight kg
066000	M 3/4"	7,0	70	35	39	43	107	54	0.3
066106	M 1"	8,0	62	31	39	43	107	54	0.3
066107	M 1 1/4"	8,0	74	37	40	43	107	54	0.6
066418	M 1 1/4"	13,0	88	44	48	43	107	54	0.8

LK 525 3W - Compression fitting

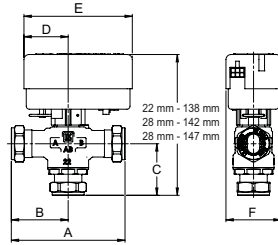

Article no.	Dim.	Kvs m ³ /h	A mm	B mm	C mm	D mm	E mm	F mm	Weight kg
066108	22 mm	8,0	110	55	50	43	107	54	0.4
066109	28 mm	8,0	110	55	54	43	107	54	0.6
066399	28 mm	13,0	114	57	59	43	107	54	0.8

LK 525 3W - Actuator and Adaptor

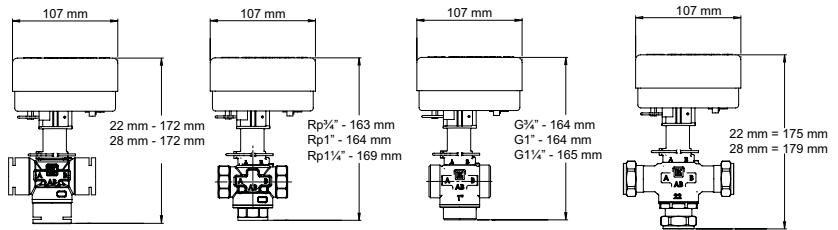

Article no.	Torque	Note	Weight kg
066177		Adapter Polar / Solar	0.03
066060	5 Nm	EMV 110-M SPST Actuator 230 VAC with Molex®	0.3
066061	5 Nm	EMV 110-K SPST Actuator 230 VAC with cable 1 m	0.3
066062	5 Nm	EMV 110-K SPST Actuator 230 VAC with cable 3 m	0.4
066063	5 Nm	EMV 110-M SPST Actuator 24 VAC with Molex®	0.3
066083		Cable-M 3x0.75 L=1 m with Molex®	0.1
50800453		Cable-M 3x0.75 L=1.7 m with Molex®	0.1

LK 525 3W SET - incl. Motor 230VAC 1m Cable - Internal thread

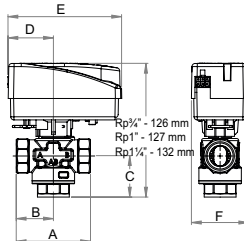

Article no.	Dim.	Kvs m ³ /h	Torque	A mm	B mm	C mm	D mm	E mm	F mm	G mm	Weight kg
066433	F 3/4"	7,0	5 Nm	70	35	39	126	43	107	54	0.6
066434	F 1"	8,0	5 Nm	74	37	40	127	43	107	54	0.6
066435	F 1 1/4"	8,0	5 Nm	84	42	45	132	43	107	54	0.9

LK 525 3W SET - incl. Motor 230VAC 1m Cable - Male thread

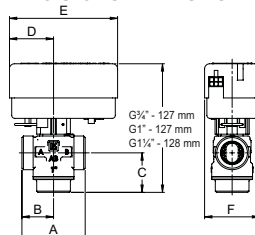

Article no.	Dim.	Kvs m ³ /h	Torque	A mm	B mm	C mm	D mm	E mm	F mm	Weight kg
066426	M 3/4"	7,0	5 Nm	70	35	39	43	107	54	0.6
066427	M 1"	8,0	5 Nm	62	31	39	43	107	54	0.6
066428	M 1 1/4"	8,0	5 Nm	74	37	40	43	107	54	0.9
066429	M 1 1/4"	13,0	5 Nm	88	44	48	43	107	54	1.1

LK 525 3W SET - incl. Motor 230VAC 1m Cable - Compression fitting

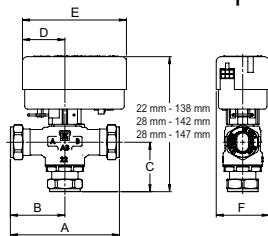

Article no.	Dim.	Kvs m ³ /h	Torque	A mm	B mm	C mm	D mm	E mm	F mm	Weight kg
066430	22 mm	8,0	5 Nm	110	55	50	43	107	54	0.7
066431	28 mm	8,0	5 Nm	110	55	54	43	107	54	0.9
066432	28 mm	13,0	5 Nm	114	57	59	43	107	54	1.1

SPARE PARTS AND ACCESSORIES



Article no.	Article	Position
187202	Insulation	1

Zone Valves

LK 527 MultiZone 2W

- Click system for actuator



TECHNICAL DATA

Max. working pressure	3.2 MPa (32 bar)
Max. differential pressure	600 kPa (6 bar)
Working temperature	Min. 2 °C/Max. 110 °C
Ambient temperature	Min. 1 °C/Max. 55 °C
Thread standard	R - male thread, Rp - female thread, G - male thread
Protection class	IP 44
Media	Water - Glycol mixture max. 50%
Electrical connection	Fixed wire
Signal connector	2-Point SPST
Cable specification	Dimension 3 x 0,75 mm ²
Wire colours	Blue, brown, black
External insulation	PVC
Actuator	230 VAC, 50 Hz
Material, valve body	Brass EN 12165 CW617N
Material, ball	Brass CW617N
Type approval certificate	Valve: DIN-DVGW*, WRAS*, ACS Actuator only



*Applies for 527 MultiZone 2W female thread

LK 527 MultiZone is a motorized 2-way ball valve with high flow capacity for applications in, for example heating, cooling and domestic water systems.

The zone valve has On/Off control and is controlled by 2-point signal.

Assembly/disassembly of actuator on the ball valve is simple and secure, using the clip-system.

The zone valve must not be installed with the actuator underneath the valve unit.

In case of a power failure, the valve stays in its current position. When the power is switched off, the valve can be manually set by the handle on the actuator.

Please note that the actuator can be installed in only one position.

The valve requires no maintenance but the installation should be checked regularly.

WIRING DIAGRAM

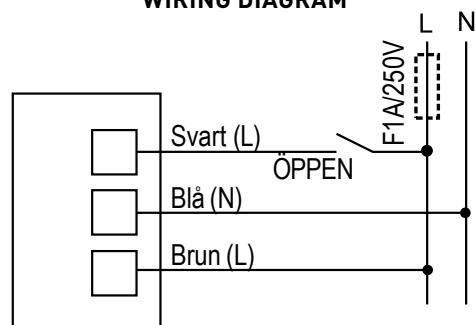

CAPACITY DIAGRAM

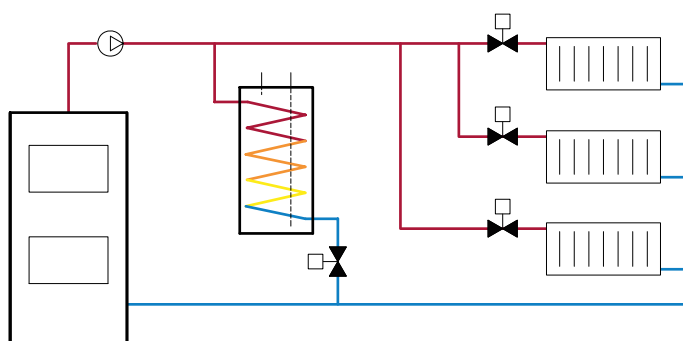
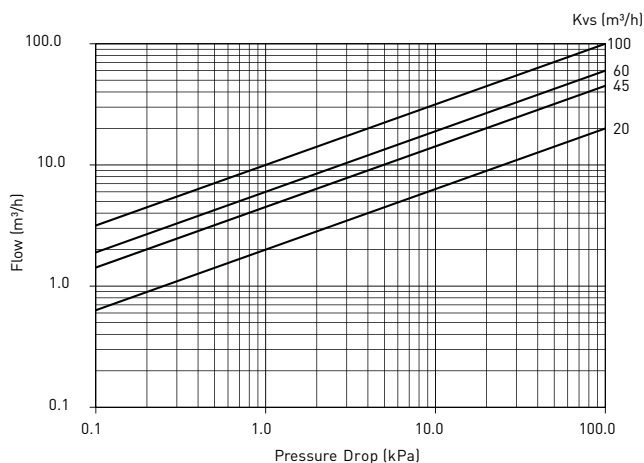

LK 527 2W - Female Thread

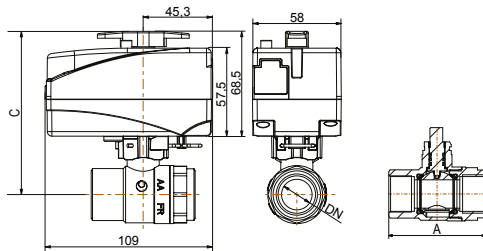

Article no.	Dim.	Kvs m ³ /h	A mm	C mm	Weight kg
066263	F 1/2"	20,0	62	104	0.6
066264	F 3/4"	45,0	68	107	0.7
066265	F 1"	60,0	81	112	0.9
066266	F 1 1/4"	100,0	86	117	1.1

Other dimensions on request.

LK 527 2W - Male thread

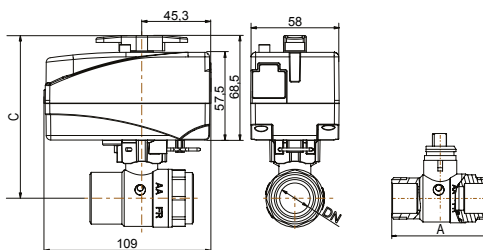

Article no.	Dim.	Kvs m ³ /h	A mm	C mm	Weight kg
066279	M 1"	45,0	74	107	0.8
066280	M 1 1/4"	60,0	82	112	1.0

Other dimensions on request.

LK 527 - Actuator

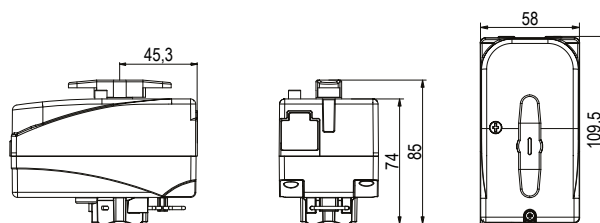

Article no.	Connection	Voltage	Torque	Operation time	Weight kg
066283	2-point SPST output, with cable 1 m	230 V	5 Nm	30s / 90°	0.4
066282	2-point SPST output, with cable 1 m	230 V	5 Nm	12s / 90°	0.4

Zone Valves

LK 527 MultiZone 3W

- Click system for actuator



TECHNICAL DATA

Max. working pressure	3.2 MPa (32 bar)
Max. differential pressure	600 kPa (6 bar)
Working temperature	Min. 2 °C/Max. 110 °C
Ambient temperature	Min. 1 °C/Max. 55 °C
Thread standard	R - male thread, Rp - female thread, G - male thread
Protection class	IP 44
Media	Water - Glycol mixture max. 50%
Electrical connection	Fixed wire
Signal connector	3-Point SPDT
Cable specification	Dimension 3 x 0.75 mm ²
Wire colours	Blue, brown, black
External insulation	PVC
Actuator	230 VAC, 50 Hz
Material, valve body	Brass CW617N
Material, ball	Brass CW617N
Type approval certificate	Valve: ACS Actuator only



LK 527 MultiZone is a motorized 3-way ball valve for applications in, for example heating, cooling and domestic water systems.

The zone valve is controlled by 3-point signal.

Assembly/disassembly of actuator on the ball valve is simple and secure, using the clip-system.

The zone valve must not be installed with the actuator underneath the valve unit.

In case of a power failure, the valve stays in its current position. When the power is switched off, the valve can be manually set by the handle on the actuator.

Please note that the actuator can be installed in only one position.

The valve requires no maintenance but the installation should be checked regularly.

WIRING DIAGRAM

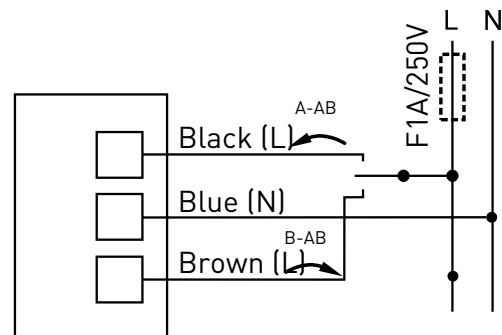

CAPACITY DIAGRAM

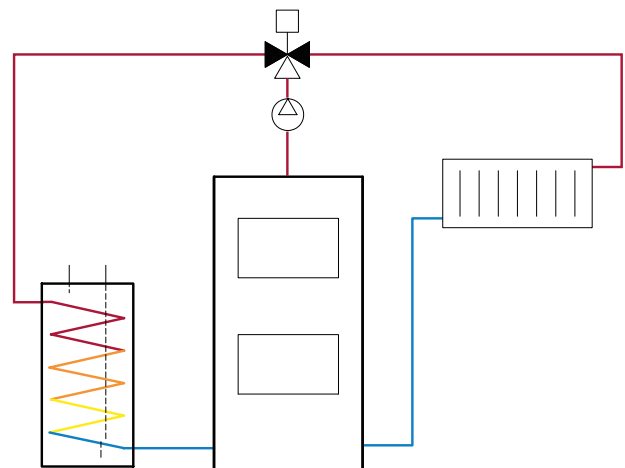
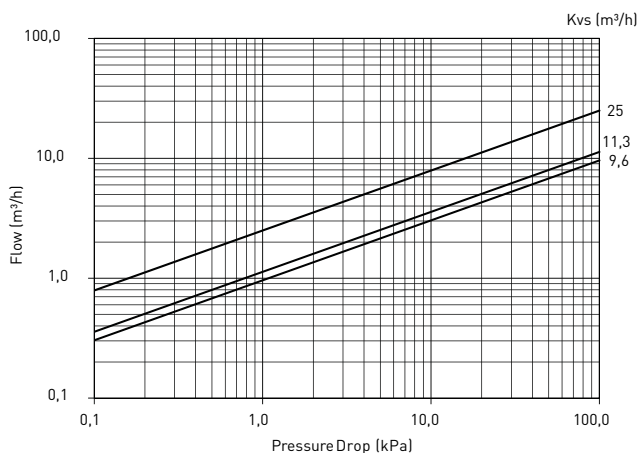

LK 527 3W - Female Thread

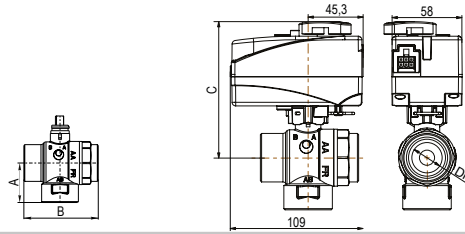

Article no.	Dim.	Kvs m ³ /h	A mm	B mm	C mm	Weight kg
066252	F 3/4"	9,6	40	68	104	0.8
066253	F 1"	11,3	43	81	107	1.0

LK 527 3W - Male Thread

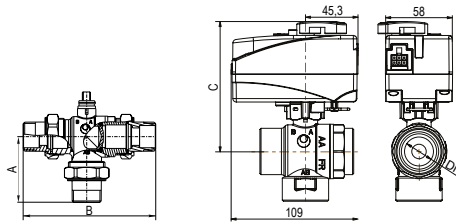

Article no.	Dim.	Kvs m ³ /h	A mm	B mm	C mm	Weight kg
066257	M 1 1/2" with transition fitting M 1 1/4"	25,0	89	165	134	2.1

LK 527 3W - Male thread

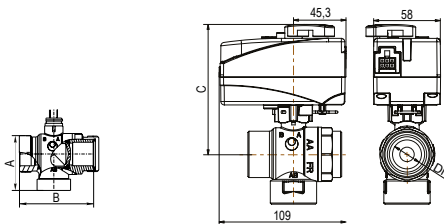

Article no.	Dim.	Kvs m ³ /h	A mm	B mm	C mm	Weight kg
066259	M 1 1/4"	11,3	43	85	107	1.0
066260	M 1 1/2"	25,0	52	90	134	1.3

LK 527 - Actuator

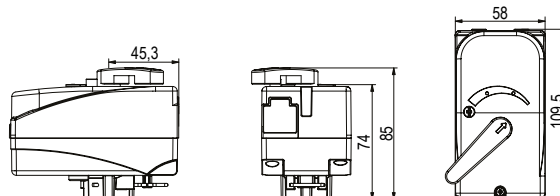

Article no.	Connection	Voltage	Torque	Operation time	Weight kg
066284	3-point SPDT output, with cable 1 m	230 V	5 Nm	20s / 90°	0.4
066287	3-point SPDT output, with cable 1 m	230 V	5 Nm	110s / 90°	0.4



Exhibition activities in 2024

Exhibitions and trade fairs are an excellent forum for us to exhibit our products and services, network with customers and other partners, and keep up to date with the latest trends in the industry.

2024 looks like being a busy year for LK Armatur in terms of trade fairs, and we hope to see you at one of these fairs in Europe during the year.

TRADE FAIRS PLANNED FOR 2024

WeBuild Energiesparmesse	Austria
Mostra Convegno Expocomfort	Italy
SHK+E	Germany
IFH/Intherm	Germany
Installer Show	United Kingdom
GET Nord	Germany



Filling Valves

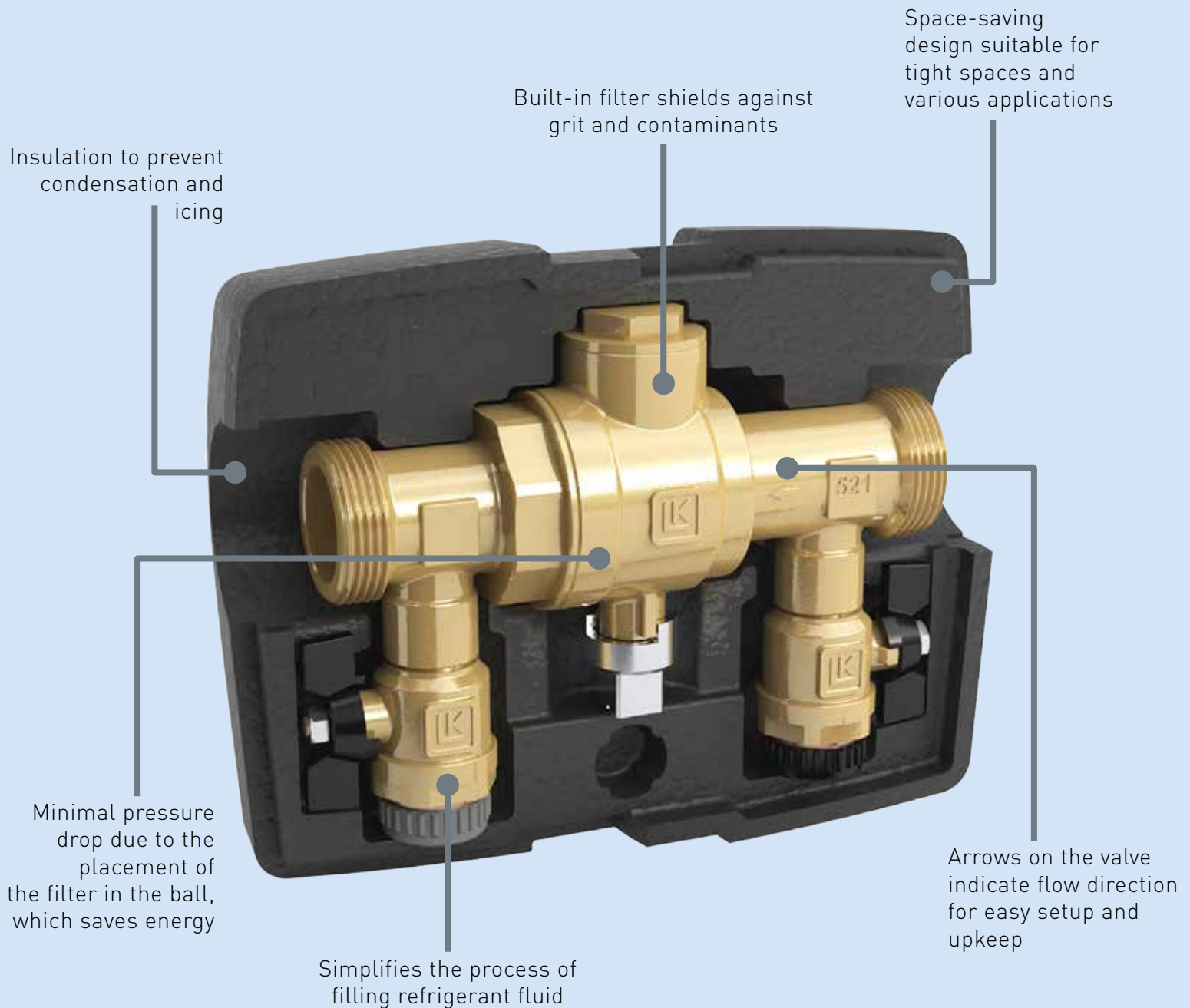

LK 521 MultiFill® simplifies refrigerant fluid filling for geothermal heat pump systems. Its built-in filter safeguards the evaporator against potential contaminants, while the compact design allows easy installation in tight spaces. Insulation protects against condensation and icing. This versatile valve can be used in various applications requiring filling and filtration.

Filling Valve

LK 321 MultiFill® Solar



- Compact design
- Quick installation



TECHNICAL DATA

Max. working pressure	1,0 MPa (10 bar)
Working temperature	Min. -20 °C/Max. 120 °C (160 °C briefly)
Thread standard	G - male thread, ISO 228/1
Media	Water - Glycol mixture max. 50%
Material, valve body	Brass EN 12165 CW617N
Material, sealing	PTFE

LK 321 MultiFill® is a compact combination valve for easy filling of solar systems. The valve's compact design makes it easy to install even in tight spaces.

Two M 1" connections with surface for connection with flange, eg. 299189 see accessories. Two filling valves M 3/4".

The valve requires no maintenance but the installation should be checked regularly.

CAPACITY DIAGRAM

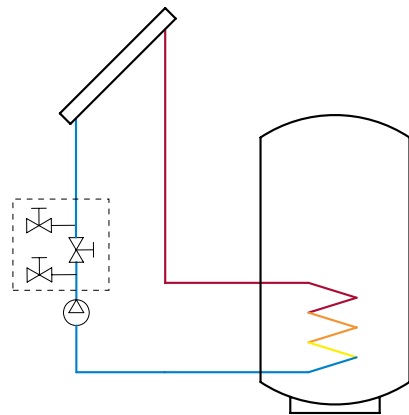
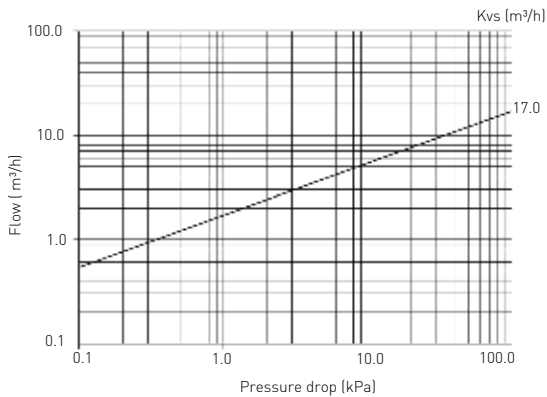

LK 321 - Male thread

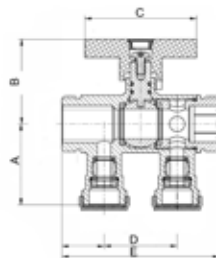

Article no.	Dim.	Kvs m³/h	A mm	B mm	C mm	D mm	E mm	Weight kg
092320	M 1" x M 3/4"	17.0	48	50	66	43	93	0.65

SPARE PARTS AND ACCESSORIES



Article no.	Article	Position
299189	Flanged pipe - 22 mm, F 1", L=120 mm	1
013035	Gasket C4400 1"	2
095410	Connection kit 22 mm x M 25	3
095411	Connection kit 18 mm x M 25	3

Filling Valve

LK 521 MultiFill®



- Compact design
- Insulation protects against condensation and icing
- Minimal pressure drop due to the placement of the filter in the ball



TECHNICAL DATA

Max. working pressure	1.0 MPa (10 bar)
Working temperature	Min. -20 °C/Max. 80 °C
Mesh opening, filter	Main valve DN25, DN32: 0,6 mm ² Main valve DN50: 1,0 mm ² Fillingvalve DN25, DN32: 0,7 mm ² > Fillingvalve DN50: 0,7 mm ²
Thread standard	G - male thread
Media	Water - Glycol mixture max. 50%
Media 2	Water - Glycol mixture max. 30%
Media 3	Water - Ethanol mixture max. 30% Working temperature: Max. 60 °C]
Material, valve body	Brass EN 12165 CW617N
Material, insulation	Expanded Polystyrene EPS
Material, sealing	EPDM
Material, filter element	(Main valve: Plastic, Stainless steel Filling valve. Stainless steel

LK 521 MultiFill® is a combination valve for easy filling of refrigerant fluid into ground source heat systems. The valve has a filter to protect the evaporator against possible grit. Its compact construction allows it to be installed in tight spaces. The valve comes with an insulation to protect against condensation and possible icing. LK 521 MultiFill® can also be used in other applications where filling and filtration are required.

Arrows on the valve body indicate the direction of the flow. The enclosed insulation should be used.

Apart from cleaning the filter no maintenance is required. The filter should be cleaned immediately after installation, a month later and then every other year or when refilling fluid to the system. Check the installation regularly.

LK 521 MULTIFILL® 25
for heat pumps, max. 12 kW

LK 521 MULTIFILL® 32
for heat pumps, max. 30 kW

LK 521 MULTIFILL® 50
for heat pumps, max. 50 kW

CAPACITY DIAGRAM

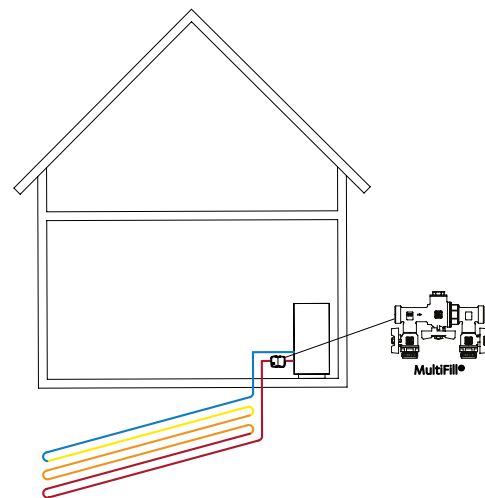
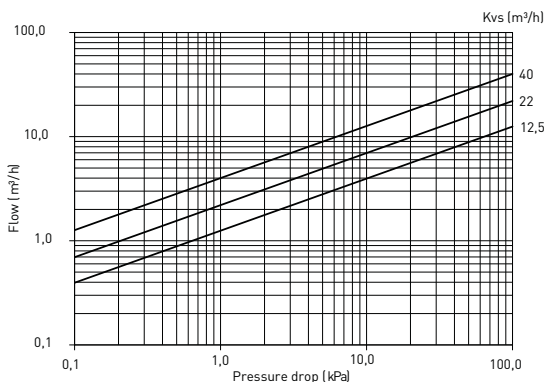

LK 521 - Male thread

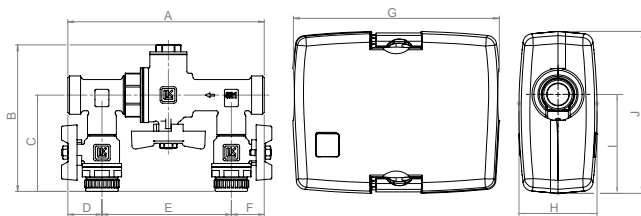

Article no.	Dim.	Dim. 2	Kvs m ³ /h	A mm	B mm	C mm	D mm	E mm	F mm	G mm	H mm	I mm	J mm	Weight kg
091480	M 1"	M 3/4"	12.5	170	127	83	29	108	29	218	83	105	171	1.3
091481	M 1 1/4"	M 3/4"	22.0	173	136	87	29	115	29	218	83	105	171	1.7

LK 521 - Male thread

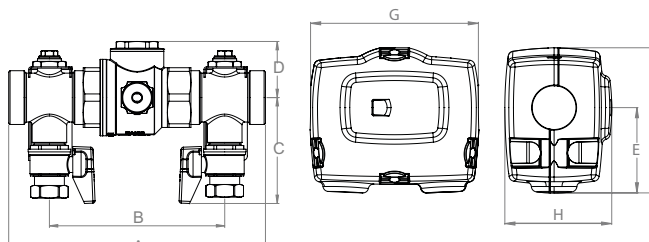

Article no.	Dim.	Dim. 2	Kvs m ³ /h	A mm	B mm	C mm	D mm	E mm	F mm	G mm	H mm	Weight kg
091483	M 2"	M 1"	40.0	284	178	118	49	156	265	308	195	4,6

SPARE PARTS AND ACCESSORIES

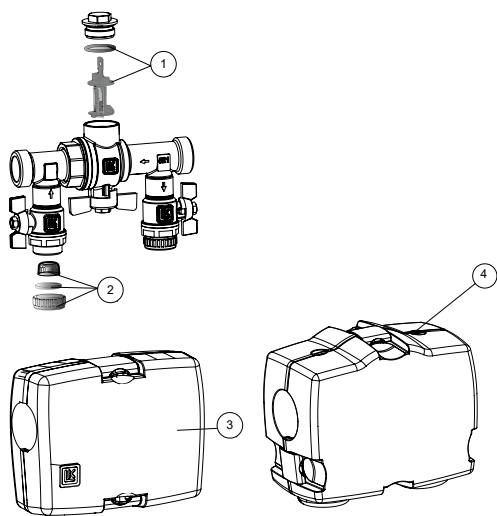

Article no.	Article	Position
095070	Filter and sealing DN 25	1
095071	Filter and sealing DN 32	1
095073	Cap, filter and sealing	2
095072	LK Insulation, 521 DN 25-32	3
187309	LK Insulation, 521 DN 50	4

Filling Valve

LK 538 ThermoFill® EA

- Integrated shut-off with ball valve and non-return valve
- The non-return valve can be inspected, which means it is classified as EA type backflow protection according to EN 1717



TECHNICAL DATA

Max. working pressure	1.0 MPa (10 bar)
Opening pressure check valve	1 kPa (0,01 bar)
Working temperature	Min. 5 °C/Max. 90 °C
Thread standard	G - male thread
Material, valve body	DZR Brass EN 12165 CW625N
Material, sealing	EPDM
Check valve	Type EA according to EN 1717
Material, check valve	POM

LK 538 ThermoFill® EA is a filling valve for heating systems. The valve has an integrated shut-off/check valve which ensures opening even at low pressure differences. The check valve is inspectionable and classified as a back flow preventer Type EA according to EN 1717.

The arrow on the valve body indicates the direction of the flow.

Male threads are sealed in the usual manner. Both the inlet side as well as the outlet side are designed according to the LK Armatur O-ring seal system. When connecting to this system, tighten first by hand until stop, then another 0.5-1.5 turns with an appropriate tool into the right position.

It is easier to fit the compression fitting if a lubricant is applied to the thread and bevel. Tighten first by hand and then with a box spanner. Number of turns to be tightened with a spanner: See the separate datasheet for compression fittings. Soft pipes are to be fitted with a support sleeve.

The valve requires no maintenance but the installation should be checked regularly.

CAPACITY DIAGRAM

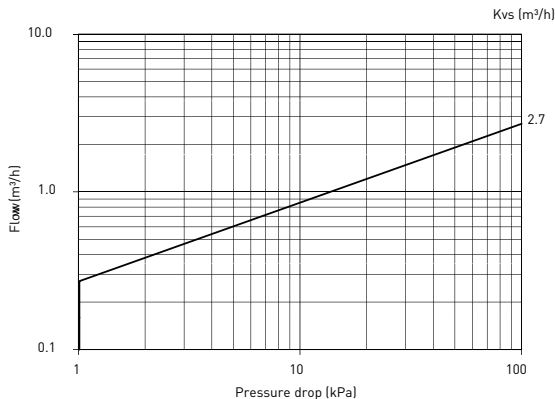

LK 538 - Male thread

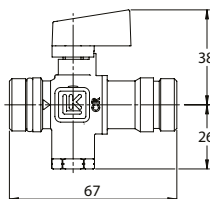

Article no.

090268

Dim.

M 1/2"

Kvs m³/h

2.7

Weight kg

0.1

LK 538 - Male thread / Compression fitting

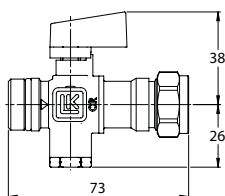

Article no.	Dim.	Kvs m ³ /h	Weight kg
090269	M 1/2" / 15 mm	2.7	0.2

LK 538 - Compression fitting

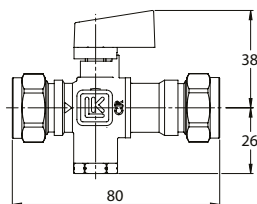

Article no.	Dim.	Kvs m ³ /h	Weight kg
090271	15 mm	2.7	0.2

Filling Valve

LK 539 ThermoFill® EA

- Integrated shut-off with ball valve and non-return valve
- The non-return valve can be inspected, which means it is classified as EA type backflow protection according to EN 1717



TECHNICAL DATA

Max. working pressure	1.0 MPa (10 bar)
Opening pressure check valve	1 kPa (0,01 bar)
Working temperature	Min. 5 °C/Max. 90 °C
Thread standard	G - male thread
Material, valve body	DZR Brass EN 12165 CW625N
Material, sealing	EPDM
Check valve	Type EA according to EN 1717
Material, check valve	POM

LK 539 ThermoFill® EA is a filling valve for heating systems. The valve has an integrated shut-off/check valve, which ensures opening even at low pressure differences. The check valve is inspectionable and classified as a back flow preventer Type EA according to EN 1717.

The arrow on the valve body indicates the direction of the flow.

Male threads are sealed in the usual manner, alternatively M 3/4" flat connection with captive nut and flat gasket.

The valve requires no maintenance but the installation should be checked regularly.

CAPACITY DIAGRAM

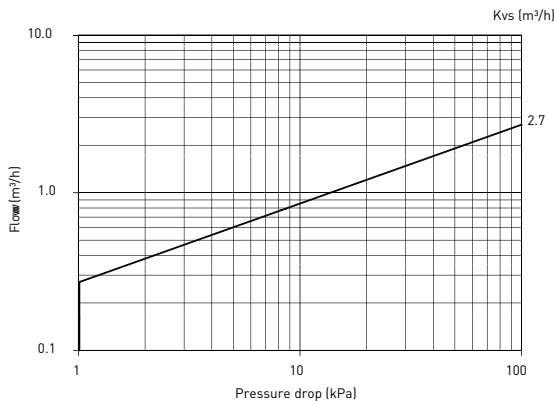

LK 539 - Male thread

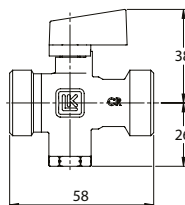

Article no.	Dim.	Kvs m ³ /h	Weight kg
068008	M 3/4"	2.7	0.2



LK 551 HydroMix – Comfort and safety in one

The LK 551 HydroMix is a mixing valve for hot water and heating systems.

The valve has built-in anti-scald protection to reduce the risk of scalding from hot water, as the valve shuts off the incoming hot water if the cold water supply is interrupted.



Valves for Water Heating

Compact design for versatile and hassle-free installation

Anti-scald function shuts off hot water if cold supply is interrupted

The thermostat-equipped mixing valve regulates hot and cold water to your desired temperature

Stable, two-piece insulation

Ideal for buildings with long water pipes, ensuring hot water reaches all areas quickly

Includes a mixing valve, cross, connection kit, and three check valves to prevent self circulation

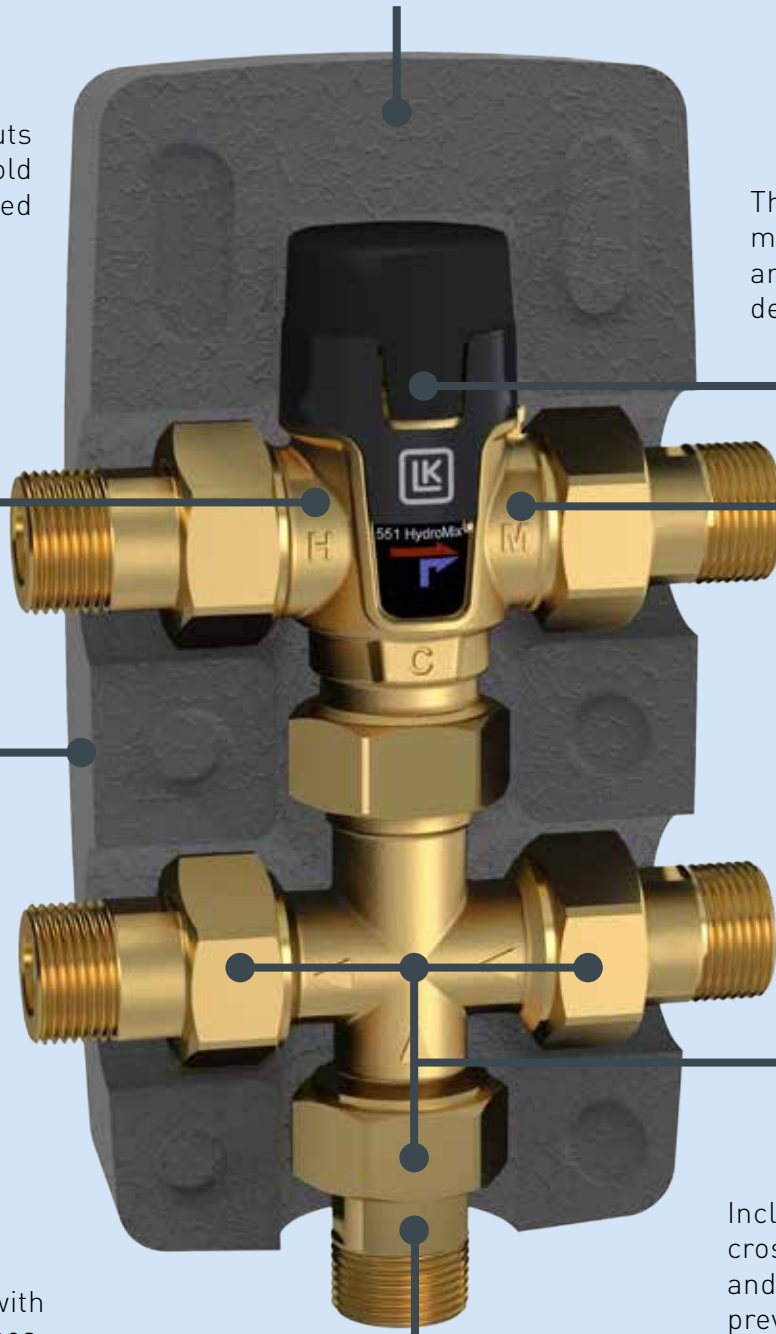

Experience instant hot water with **LK 551 HydroKit HWC**, even in buildings with lengthy water pipes. This compact unit includes a mixing valve, cross, connection kit, and three check valves for seamless hot water circulation. The thermostat-controlled mixing valve blends cold and hot water for an improved hot water experience, with added safety from the anti-scald feature.

Safety Relief Valves

LK 510/511/512 MultiSafe

- From 1.5 to 10 bar
- Protect your boiler against overpressure



TECHNICAL DATA

Working temperature	Min. -15 °C/Max. 90 °C (120 °C briefly)
Thread standard	G - male thread, G - female thread
Material, valve body	DZR Brass EN 12165 CW625N
Material, sealing	EPDM
CE	LK 511 and LK 512 are fitted with a CE-marked LK 510 valve with installed nipple.

It is easier to fit the compression fitting if a lubricant is applied to the thread and bevel. Tighten first by hand and then with a box spanner. Number of turns to be tightened with a spanner: See the separate datasheet for compression fittings. Soft pipes are to be fitted with a support sleeve.

The safety relief valve requires no maintenance. The opening function should, however, be checked 2-3 times a year.:

Turn the knob counterclockwise by hand, until water flows out. Let the water flush through for a moment. Then turn the knob until a click is heard, about ¼ turn, and the valve returns to closed position.

The safety relief valve may open after a large discharge from the water heater. This is a normal function since the pressure relief level in the water heater can be reached due to the increased volume of the water when heated.

LK 510/511/512 MultiSafe is a safety relief valve for tap water installations, as well as heating systems with closed boiler system with a power of max.50 kW. The valve must not be used for steam. The outlet is fitted with compression fitting for simple installation of a discharge pipe.

The safety relief valve can be installed horizontally or vertically, i.e. with the valve knob facing outwards or upwards. In horizontal installations the outlet must be positioned so that a water pocket cannot be formed. The thread has to be sealed in the usual manner.

LK 510 - Female thread / Compression fitting - Tap water

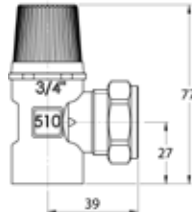

Article no.	Dim.	Opening pressure	Discharge capacity	Weight kg
090033	F ¾" x 22 mm	0.9 MPa	112 l/min.	0.2
090034	F ¾" x 22 mm	1.0 MPa	133 l/min.	0.2

LK 510 - Female thread / Compression fitting - Heating

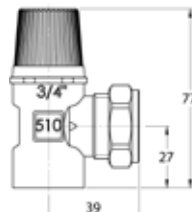

Article no.	Dim.	Opening pressure	Discharge capacity	Weight kg
090030	F ¾" x 22 mm	0.15 MPa	35 l/min.	0.2
090035	F ¾" x 22 mm	0.2 MPa	35 l/min.	0.2
090031	F ¾" x 22 mm	0.25 MPa	38 l/min.	0.2
090036	F ¾" x 22 mm	0.3 MPa	40 l/min.	0.2

LK 510 - Female thread - Heating

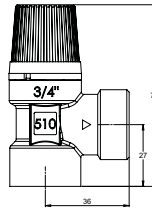

Article no.	Dim.	Opening pressure	Discharge capacity	Weight kg
055505	F 3/4"	0.15 MPa	35 l/min.	0.2
055506	F 3/4"	0.25 MPa	38 l/min	0.2

LK 511 - Male thread / Compression fitting - Tap water

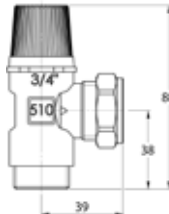

Article no.	Dim.	Opening pressure	Discharge capacity	Weight kg
090043	M 3/4" x 22 mm	0.9 MPa	112 l/min.	0.2
090044	M 3/4" x 22 mm	1.0 MPa	133 l/min.	0.2

LK 511 - Male thread / Compression fitting - Heating

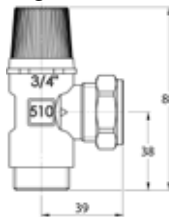

Article no.	Dim.	Opening pressure	Discharge capacity	Weight kg
090040	M 3/4" x 22 mm	0.15 MPa	35 l/min.	0.2
090047	M 3/4" x 22 mm	0.2 MPa	35 l/min.	0.2
090041	M 3/4" x 22 mm	0.25 MPa	38 l/min.	0.2
090048	M 3/4" x 22 mm	0.3 MPa	40 l/min.	0.2

LK 512 - Compression fitting - Tap water

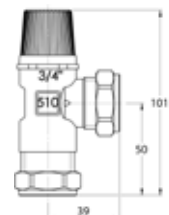

Article no.	Dim.	Opening pressure	Discharge capacity	Weight kg
090053	22 mm	0.9 MPa	112 l/min.	0.3
090054	22 mm	1.0 MPa	133 l/min.	0.3

LK 512 - Compression fitting - Heating

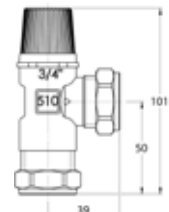

Article no.	Dim.	Opening pressure	Discharge capacity	Weight kg
090050	22 mm	0.15 MPa	35 l/min.	0.3
090051	22 mm	0.25 MPa	38 l/min.	0.3

Safety Relief Valve

LK 514 MultiSafe

- O-ring connection suitable for LK's range of valves
- From 1.5 to 10 bar
- Protect your boiler against overpressure



TECHNICAL DATA

Working temperature	Min. -15 °C/Max. 90 °C (120 °C briefly)
Thread standard	G - male thread
Material, valve body	DZR Brass EN 12165 CW625N
Material, sealing	EPDM



LK 514 MultiSafe is a high lift, soft sealing safety relief valve for tap water installations as well as heating, recycling and cooling systems with thermal expansion only. The valve must not be used for steam. The outlet is fitted with compression fitting for simple installation of a discharge pipe.

The safety relief valve can be installed horizontally or vertically, i.e. with the valve knob facing outwards or upwards. In horizontal installations, the outlet must be positioned so that water pockets cannot be formed.

The male thread is designed for the LK Armatur system with O-ring seal where the valve is first tightened by hand until stop and then with a spanner, 0.5-1.5 turns until the desired position is achieved. If the valve is fitted to other components than an LKA valve, the thread has to be sealed in the usual manner.

The safety relief valve requires no maintenance but the opening function should be checked 2-3 times per year according to the following:

Turn the knob counter-clockwise ¼ turn until a faint "click" is heard. Let the water flush through briefly, then turn another ¼ turn until a stronger "click" is heard and the valve closes.

This two-step opening function makes it possible to use the safety valve discharge pipe to drain e.g. a water heater.

It is normal for the safety relief valve to open and let out some water when the pressure level of the system is reached due to the water's increasing volume during heating.

LK 514 Male thread / Compression fitting

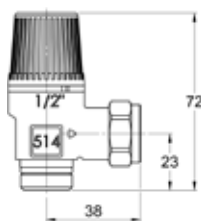

Article no.	Dim.	Opening pressure	Discharge capacity	Weight kg
090109	M 1/2" x 15 mm	0.15 MPa	31 l/min.*	0.1
090108	M 1/2" x 15 mm	0.2 MPa	35 l/min.*	0.1
090110	M 1/2" x 15 mm	0.25 MPa	50 l/min.*	0.1
090111	M 1/2" x 15 mm	0.3 MPa	81 l/min.*	0.1
090112	M 1/2" x 15 mm	0.4 MPa	96 l/min.*	0.1
090113	M 1/2" x 15 mm	0.6 MPa	118 l/min.*	0.1
090114	M 1/2" x 15 mm	0.7 MPa	104 l/min.*	0.1
090115	M 1/2" x 15 mm	0.9 MPa	122 l/min.*	0.1
090116	M 1/2" x 15 mm	1.0 MPa	148 l/min.*	0.1

[According to Swedish Standard WA 93]

Valve combination

LK 322 CoolUnit

- Insulation against condensation
- Energy effective way for free cooling
- Recharge the borehole during the summer



TECHNICAL DATA

Max. working pressure	0,6 MPa (6 bar)
Working temperature	Min. -20 °C/Max. 80 °C
Thread standard	G - male thread
Media	Water - Glycol mixture max. 50%
Material, valve body	Brass EN 12165 CW617N
Material, sealing	EPDM

The LK 322 CoolUnit is a valve combination that utilises the cold available in a system with a geothermal heat pump.

By running the refrigerant fluid in the collector hose to a fan coil, you can cool your home with the cold naturally found in the ground. In addition, the borehole is recharged during the summer, which increases the performance of the heat pump.

The LK 322 CoolUnit also contains a non-return valve to ensure the liquid is run in the right direction when fitting the shunt group with its own circulation pump. See LK HydronicGroup 90C for a suitable shunt group.

The LK 322 have two 1" male thread for connection to the collector pipe. Two ball valves with 3/4" male thread for connection to convector pipe.

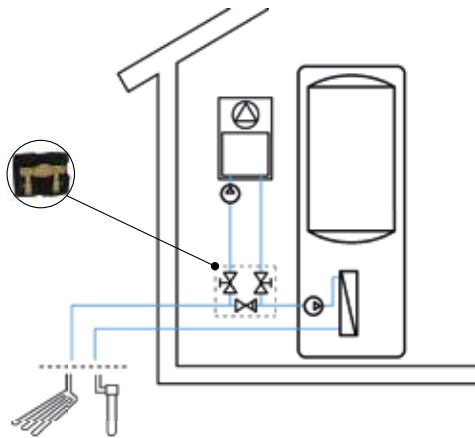

LK 322

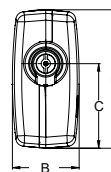
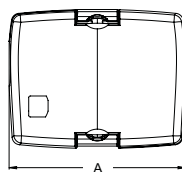

Article no.	Dim.	Kvs m ³ /h	A mm	B mm	C mm	D mm	Weight kg
092366	1"	9.5	218	83	105	171	1.6
092367	1¼"	16	218	83	105	171	1.7

SPARE PARTS AND ACCESSORIES

	1.	2.	3.	Article no.	Article	Position
				095072	LK Insulation, 521 DN 25-32	1
				299189	Flanged pipe - 22 mm, F 1", L=120 mm	2
				299190	Flanged pipe - 28 mm, F 1¼", L=120 mm	2
				299387	LK 90C - Pump group for cooling	3

Valve Combination

LK 548 AquaKit

- O-ring connection suitable for LK's range of valves
- Complete valve combination



TECHNICAL DATA

Max. working pressure	1.0 MPa (10 bar)
Opening pressure check valve	5 kPa (0,05 bar)
Working temperature	Min. 5 °C/Max. 90 °C
Operating temperature	Min. 38 °C/Max. 65 °C
Material, valve body	DZR Brass EN 12165 CW625N
Material, sealing	EPDM

LK 548 is AquaKit a valve combination for water heating consisting of a shut-off/check valve and a thermostatic mixing valve. The shut-off valve closes the cold water inlet and has an integrated check valve preventing recirculation of warm water into the incoming cold water pipe. The mixing valve regulates the supply of cold water in order to achieve the desired temperature. The shut-off/check valve has two connections with female thread M 1/2" for fitting of a safety relief valve, vacuum breaker or filling valve.

Arrows on the valve body indicate the direction of the flow.
 KV = incoming cold water
 VV = incoming hot water
 BV = outgoing warm water

Female thread connections are designed for the LK Armatur O-ring seal system. Other components are fitted in the usual way. When fitting to a male thread connection, adapter LK 373 is used - see under Accessories.

When fitted on top of boiler/storage tanks with built-in water heaters the valve combination should be installed with some space between boiler/storage tank and valve combination so as not to let the function of the valve combination be affected by heat radiation.

The valve knob is used to set the desired warm water temperature within the range of 38 °C to 65 °C. The maximum temperature can be calibrated as follows:

INCREASING THE MAXIMUM TEMPERATURE:

Turn the knob anticlockwise to (+). Loosen the screw and move the knob out to the side. Then turn the knob clockwise to (-) without it being engaged. Adjustments are carried out in small steps. A 1/4 turn corresponds to approximately 7 °C. Reinstall the knob and check that it engages with the teeth. Tighten the screw and then turn the knob to max (+). Max calibration for increasing the temperature is a 1/2 turn.

REDUCING THE MAXIMUM TEMPERATURE:

Do the procedure in reverse. Turn the knob clockwise to (-) and the disengaged knob anticlockwise to (+).

CAPACITY DIAGRAM

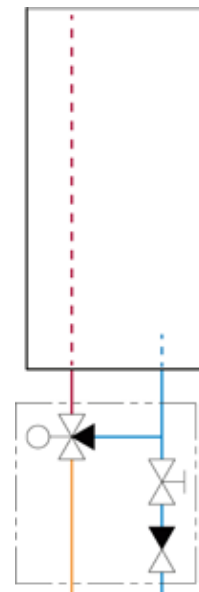
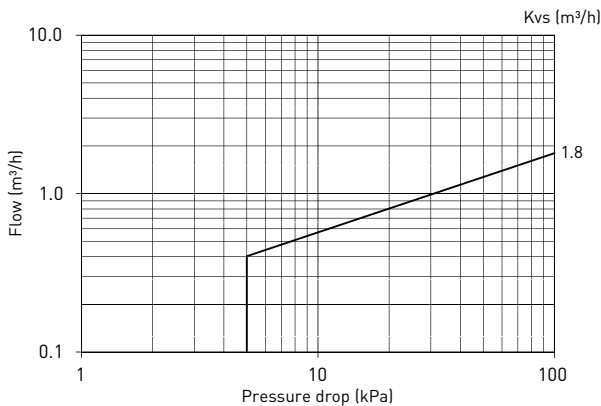

LK 548 - Compression fitting

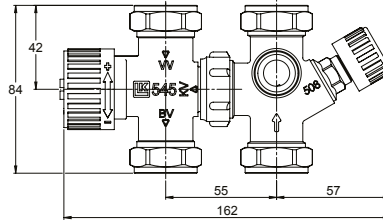

Article no.	Dim.	Kvs m ³ /h	Weight kg
090085	22 mm	1.8	0.7

SPARE PARTS AND ACCESSORIES

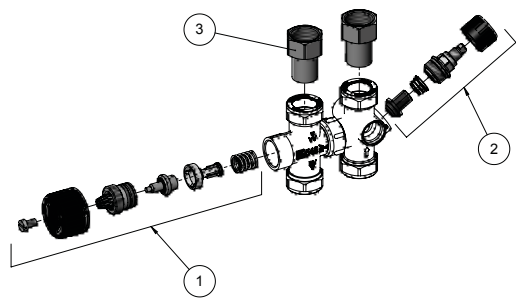

Article no.	Article	Position
4920723	LK 683 Repair kit, Mixing valve	1
4311733	LK 684 Repair kit, Shut-off/Check valve	2
1898055	Adapter LK 373 22 x M 3/4"	3

Thermic Mixing Valves

LK 550 AquaMix

- Temperature control
- DZR Brass



TECHNICAL DATA

Max. working pressure	1.0 MPa (10 bar)
Working temperature	Min. 5 °C/Max. 90 °C
Operating temperature	Min. 38 °C/Max. 65 °C
Thread standard	G - male thread
Material, valve body	DZR Brass EN 12165 CW625N
Material, sealing	EPDM

LK 550 AquaMix is a mixing valve for water heating with a thermostatic element that regulates the supply of cold water in order to achieve the desired temperature. Self-circulation is prevented with a check valve installed in the cold water supply - see under Accessories. Valves with male thread M 1/2" and 15 mm compression fitting have an airvent for simple draining of smaller water heaters.

Arrows on the valve body indicate the direction of the flow.

KV = incoming cold water

VV = incoming hot water

BV = outgoing warm water

When fitting to a male thread connection adapter LK 373 is used - see under Accessories.

When fitted on top of boiler/storage tanks with built-in water heaters the valve should be installed with some space between boiler/storage tank and valve so as not to let the function of the valve be affected by heat radiation.

The valve knob is used to set the desired warm water temperature within the range of 38 °C to 65 °C. The maximum temperature can be calibrated as follows:

INCREASING THE MAXIMUM TEMPERATURE:

Turn the knob anticlockwise to (+). Loosen the screw and move the knob out to the side. Then turn the knob clockwise to (-) without it being engaged. Adjustments are carried out in small steps. A 1/4 turn corresponds to approximately 7 °C. Reinstall the knob and check that it engages with the teeth. Tighten the screw and then turn the knob to max (+). Max. calibration for increasing the temperature is a 1/2 turn.

REDUCING THE MAXIMUM TEMPERATURE:

Do the procedure in reverse. Turn the knob clockwise to (-) and the disengaged knob anticlockwise to (+).

CAPACITY DIAGRAM

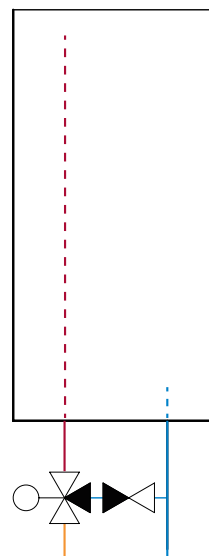
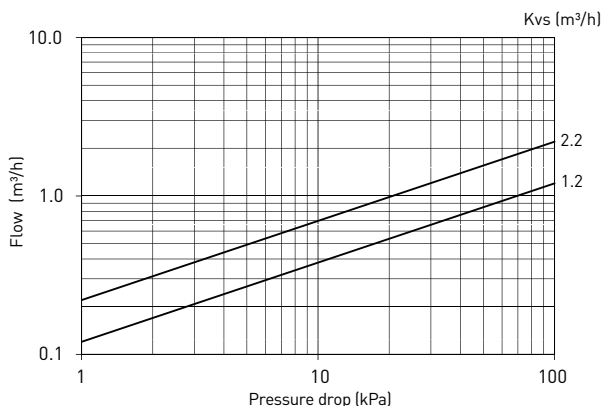

LK 550 - Male thread

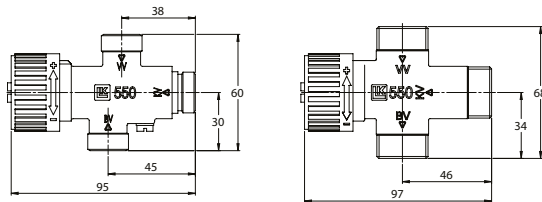

Article no.	Dim.	Kvs m ³ /h	Weight kg
090206	M 1/2"	1.2	0.3
090063	M 3/4"	2.2	0.4
090528	M 1"	2.2	0.5

LK 550 - Compression fitting

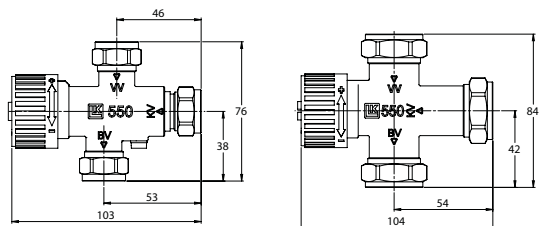

Article no.	Dim.	Kvs m ³ /h	Weight kg
090200	15 mm	1.2	0.3
090205	22 mm	2.2	0.4

SPARE PARTS AND ACCESSORIES

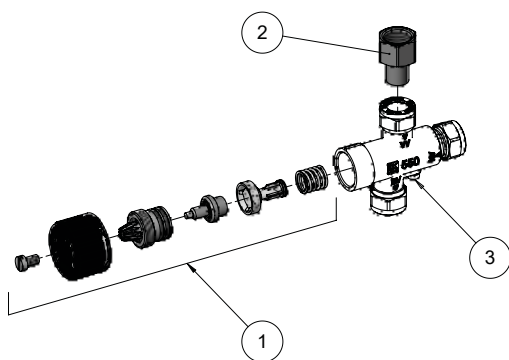

Article no.	Article	Position
055008	Check valve NN 1/2"	-
055009	Check valve NN 3/4"	-
092105	528 Cartridge Check valve 15 mm	-
092103	528 Cartridge Check valve 22 mm	-
4920723	LK 683 Repair kit, Mixing valve	1
1898055	Adapter LK 373 22 x M 3/4"	2
052002	LK 373 Adapter 15 x M 1/2"	2
187224	Airschrew	3

Thermic Mixing Valve

LK 551 HydroMix



- Anti-scald function
- Adjustable temperature

TECHNICAL DATA

Max. working pressure	1.0 MPa (10 bar)
Working temperature	Min. 5 °C/Max. 65 °C Min. 5 °C/Max. 95 °C
Operating temperature	Min. 10 °C/Max. 30 °C (Max. 65 °C) Min. 25 °C/Max. 45 °C Min. 35 °C/Max. 55 °C Min. 35 °C/Max. 65 °C
Thread standard	Rp - female thread, G - male thread
Media	Water - Glycol mixture max. 50% Ethanol mixture max. 30%
Material, valve body	Brass EN 12165 CW617N, DZR Brass EN 12165 CW625N
Temperature stability	±3 °C

LK 551 HydroMix is an asymmetrical mixing valve for water heating and heating systems. The mixing valve has a thermostatic element that regulates the supply of cold as well as hot water in order to achieve the desired temperature. The valve has an anti-scald function that shuts off the incoming hot water flow in case of failure of cold water supply.

Arrows on the valve body indicate the direction of the flow.

C = incoming cold water

H = incoming hot water

M = outgoing mixed water

When fitted on top of boiler/storage tanks with built-in water heaters the valve should be installed with some space between boiler/storage tank and valve so as not to let the function of the valve be affected by heat radiation.

The valve knob is used to set the desired warm water temperature within the specified range. The protective cap prevents unintentional changes of the temperature setting.

The valve requires no maintenance but the installation should be checked regularly.

CAPACITY DIAGRAM

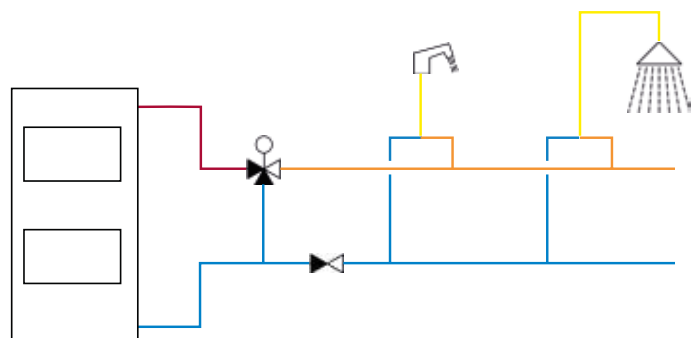
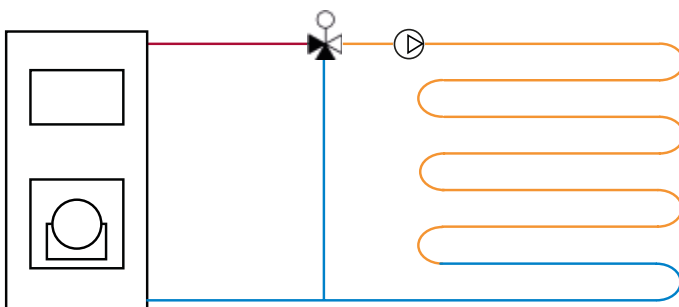
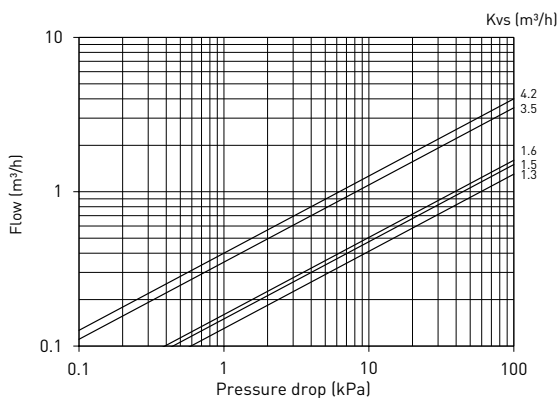

LK 551 - Female thread

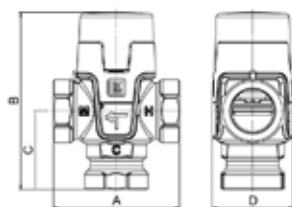

Article no.	Dim.	Kvs m ³ /h	A mm	B mm	C mm	D mm	Note	Weight kg
181616	F 1/2"	1.5	70	99	43.5	45	25 - 45 °C	0.5
181617	F 3/4"	1.6	70	99	43.5	45	25 - 45 °C	0.5
181455	F 1/2"	1.5	70	99	43.5	45	35 - 65 °C	0.5
181486	F 3/4"	1.6	70	99	43.5	45	35 - 65 °C	0.5
182203	F 1"	3.5	84	121	62	55	10 - 30 °C	0.9
182204	F 1"	4.2	84	121	62	55	25 - 45 °C	0.9
182205	F 1"	3.5	84	121	62	55	35 - 65 °C	0.9

LK 551 - Male thread

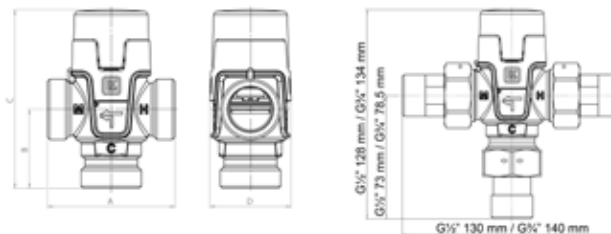

Article no.	Dim.	Kvs m ³ /h	A mm	B mm	C mm	D mm	Note	Weight kg
181618	M 1/2"	1.3	70	42.5	99	45	25 - 45 °C	0.4
181619	M 3/4"	1.5	70	43.5	99	45	25 - 45 °C	0.5
181620	M 1"	1.6	70	43.5	99	45	25 - 45 °C	0.5
181452	M 1/2"	1.3	70	42.5	99	45	35 - 65 °C	0.4
181453	M 3/4"	1.5	70	43.5	99	45	35 - 65 °C	0.5
181454	M 1"	1.6	70	43.5	99	45	35 - 65 °C	0.5
182736	M 1"	1,6	70	43,5	99	45	35 - 65 °C *	0,5
182197	M 1"	3.5	84	62	121	55	10 - 30 °C	0.7
182198	M 1"	3.5	84	62	121	55	25 - 45 °C	0.7
182199	M 1"	3.5	84	62	121	55	35 - 65 °C	0.7
182200	M 1 1/4"	3.5	84	62	121	55	10 - 30 °C	0.8
182201	M 1 1/4"	4.2	84	62	121	55	25 - 45 °C	0.8
182202	M 1 1/4"	3.5	84	62	121	55	35 - 65 °C	0.8

* Material, valve body: EN 12165 CW625N

LK 551 - Compression fitting

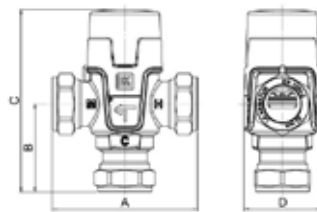

Article no.	Dim.	Kvs m ³ /h	A mm	B mm	C mm	D mm	Note	Weight kg
181621	15 mm	1.3	86.5	51	106	45	25 - 45 °C	0.4
181622	22 mm	1.6	85	52	106	45	25 - 45 °C	0.4
181523	15 mm	1.3	86.5	51	106	45	35 - 55 °C	0.5
181487	22 mm	1.6	85	52	106	45	35 - 55 °C	0.6
181456	15 mm	1.3	86.5	51	106	45	35 - 65 °C	0.5
182738	15 mm	1,3	86,5	51	106	45	35 - 65 °C *	0,5
181457	22 mm	1.6	85	52	106	45	35 - 65 °C	0.6
182737	22 mm	1,6	85	52	106	45	35 - 65 °C *	0,6
182206	28 mm	3.5	110	80	138	55	10 - 30 °C *	0.9
182207	28 mm	4.2	110	80	138	55	25 - 45 °C *	0.9
182208	28 mm	3.5	110	80	138	55	35 - 65 °C *	0.9

* Material, valve body: EN 12165 CW625N

LK 551 - Rotating nut

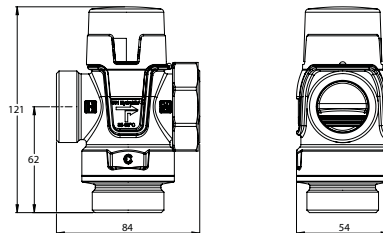

Article no.	Dim.	Dim. 2	Kvs m ³ /h	A mm	B mm	C mm	D mm	Note	Weight kg
182431	M 1 1/4"	1 1/2" Rotating nut	3.5	84	62	121	55	25 - 45 °C	0.9

SPARE PARTS AND ACCESSORIES

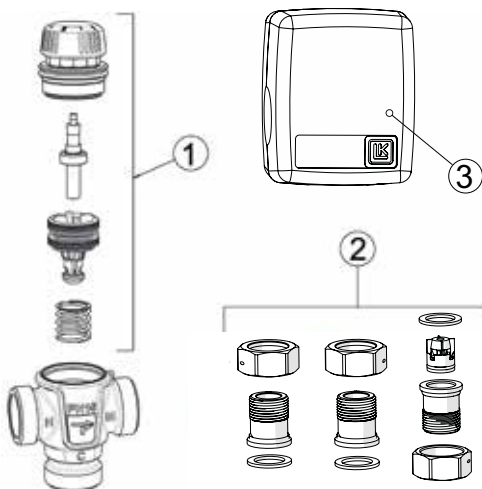

Article no.	Article	Position
095234	Repair kit 551, 35 - 65 °C (Kvs 1.6)	1
095235	Repair kit 551, 25 - 45 °C	1
095236	Repair kit 551, 35 - 55°C	1
095348	Repair kit 551, 10 - 30 °C (Kvs 3.2-4.2)	1
095349	Repair kit 551, 25 - 45 °C, Kvs 3.2-4.2	1
095350	Repair kit 551, 35 - 65 °C, Kvs 3.2-4.2	1
092052	Connection kit M 3/4" x 1" with rotating nut, gaskets, 1 check valve	2
092053	Connection kit M 3/4" x 1" with rotating nut, gaskets, 2 check valves	2
092054	Connection kit M 1/2" x 3/4" with rotating nut, gaskets, 1 check valve	2
092055	Connection kit M 1/2" x 3/4" with rotating nut, gaskets, 2 check valves	2
092333	Connection kit M 1" x 1 1/4" with rotating nut, gaskets, 1 check valve	2
092334	Connection kit M 1" x 1 1/4" with rotating nut, gaskets, 2 check valves	2
187304	LK Insulation, 551 (Kvs 1.3-1.6)	3
187310	LK Insulation, 551 (Kvs 3.2-4.2) / 552	3

Diverting Valve

LK 551 HydroMix F



- Adjustable diverting temperature



TECHNICAL DATA

Max. working pressure	1.0 MPa (10bar)
Working temperature	Min. 5 °C/Max. 95 °C
Diverting temp.:	Min. 42 °C/Max. 52 °C
Thread standard	G - male thread
Media	Water - Glycol mixture max. 50% Ethanol mixture max. 30%
Material, valve body	Brass EN 12165 CW617N, DZR Brass EN 12165 CW625N
Temperature stability	±3 °C

The LK 551 HydroMix F is a 3-way diverting valve.

Once the media reaches chosen temperature it will be redirected to port C. Below chosen temperature it will be redirected to port H.

Arrows on the valve body indicate the direction of the flow.

M = incoming water

C = outgoing hot water

H = outgoing cold water

The valve requires no maintenance but the installation should be checked regularly.

CAPACITY DIAGRAM

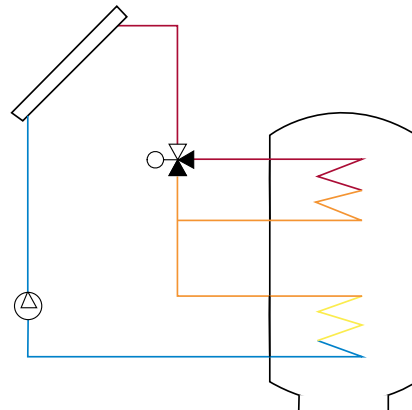
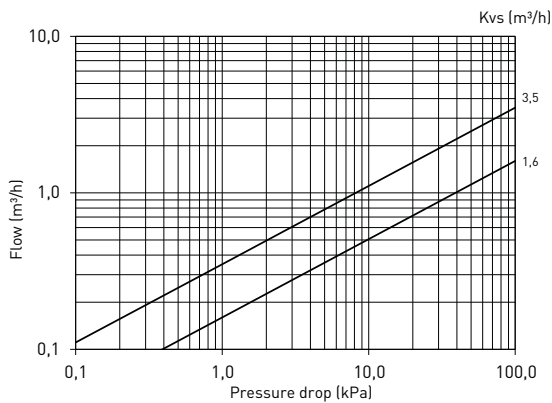

LK 551 F - Male thread

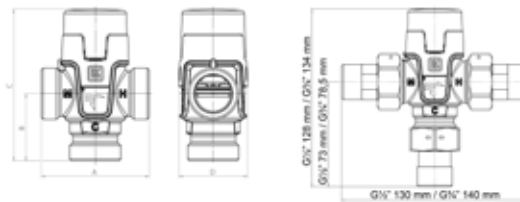

Article no.	Dim.	Kvs m ³ /h	A mm	B mm	C mm	D mm	Note	Weight kg
182143	M 1"	1.6	70	43.5	99	45	42 - 52 °C	0.5
182428	M 1"	3.5	84	62	121	55	42 - 52 °C	0.7

SPARE PARTS AND ACCESSORIES

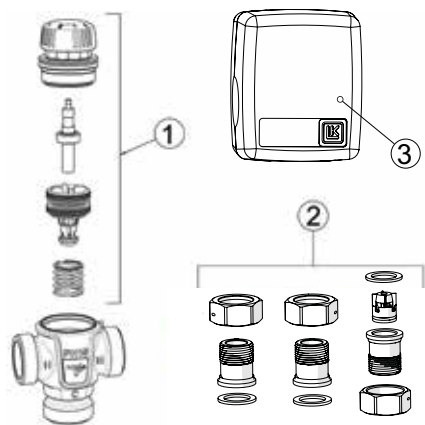

Article no.	Article	Position
095075	Repair kit 551 F, 42 - 52 °C. Kvs 1.6	1
095444	Repair kit 551 F, 42 - 52 °C. Kvs 3.5	1
092052	Connection kit M 3/4" x 1" with rotating nut, gaskets, 1 check valve	2
092053	Connection kit M 3/4" x 1" with rotating nut, gaskets, 2 check valves	2
187304	LK Insulation, 551 (Kvs 1.3-1.6)	3
187310	LK Insulation, 551 (Kvs 3.2-4.2) / 552	3

Valve Combination

LK 551 HydroKit Solar

- Simple installation
- Plug and play
- Scald protection



TECHNICAL DATA

Max. working pressure	1.0 MPa (10 bar)
Working temperature	Min. 5 °C/Max. 95 °C
Operating temperature	Min. 35 °C/Max. 65 °C
Diverting temperature	Min. 42 °C/Max. 52 °C
Thread standard	G - male thread
Media	Water - Glycol mixture max. 50% Ethanol mixture max. 30%
Material, valve body	Brass EN 12165 CW617N
Temperature stability	±3 °C

LK 551 HydroKit Solar is a valve combination, designed to energy optimize water heating from two different heat sources. In order to maintain the set water temperature, the warm water from one heat source is mixed and led directly to the mixed water outlet or if needed diverted to an other heat source for further heating.

LK 551 HydroKit Solar has two thermic valves; one diverting valve and one mixing valve with anti-scald function. The warm water temperature, for the mixing valve, is adjustable within the range of 35 °C to 65 °C and for the diverting valve the temperature is adjustable within the range of 42 °C to 52 °C.

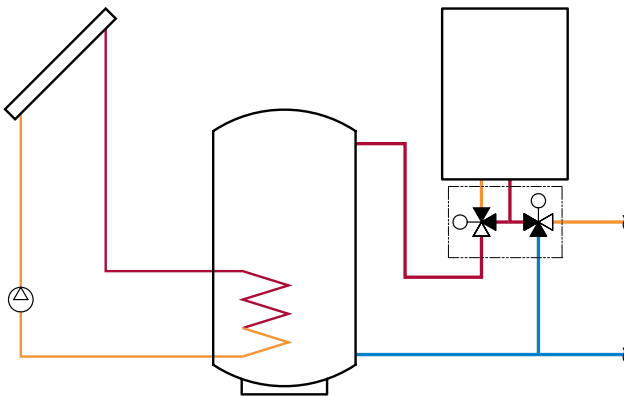

LK 551 HydroKit Solar - with connection kit

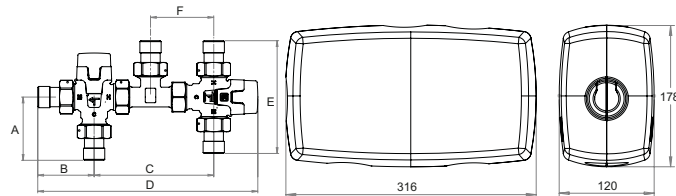

Article no.	Dim.	Kvs m ³ /h	A mm	B mm	C mm	D mm	E mm	F mm	Note	Weight kg
181588	M 3/4"	1.6	79	70	149	273	140	79		1.6
182292	M 3/4"	1.6	79	70	149	55	140	79	Insulation included	1.7
182294	M 3/4"	2.5	97	77	149	280	140	79	Insulation included	1.7
182674	M 3/4"	3.5	97	77	175	310	154	100		2.5

Connection kit included: contains nuts, gaskets, fittings (5 pcs of each) check valves (2 pcs).

LK 551 HydroKit Solar

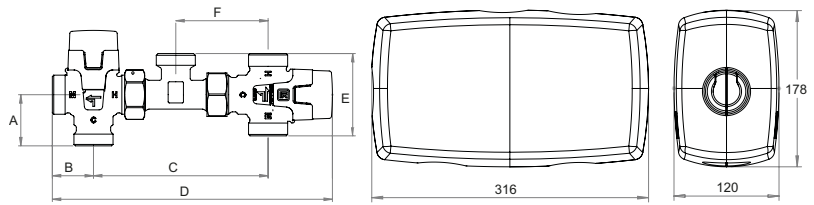

Article no.	Dim.	Kvs m ³ /h	A mm	B mm	C mm	D mm	E mm	F mm	Note	Weight kg
181690	M 1"	1.6	44	35	149	238	70	79		1.6
182293	M 1"	1.6	44	35	149	238	70	79	Insulation included	1.7
182295	M 1"	2.5	62	42	149	245	70	79	Insulation included	1.7
182427	M 1"	3.5	62	42	174	269	84	97		1.9

SPARE PARTS AND ACCESSORIES

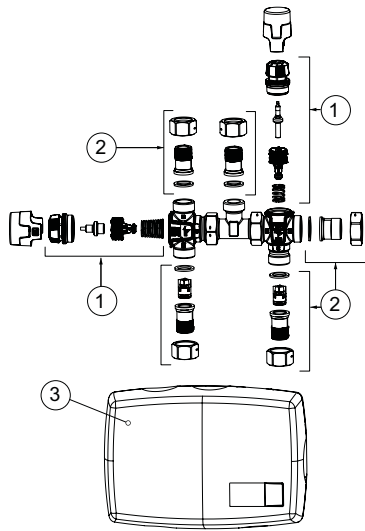

Article no.	Article	Position
095234	Repair kit 551, 35 - 65 °C (Kvs 1.6)	1
095075	Repair kit 551 F, 42 - 52 °C	1
095350	Repair kit 551, 35 - 65 °C, Kvs 3.2-4.2	1
095444	Repair kit 551 F, 42 - 52 °C. Kvs 3.5	1
095389	Connection kit M 3/4" x 1" with rotating nut, gaskets, 2 check valves	2
095390	LK Insulation (Kvs 1.6 - 2.5)	3
095459	LK Insulation (Kvs 3.5)	3

Hot Water Circulation Unit

LK 551 HydroKit HWC

- Direct hot water
- Plug and play
- Scald protection



TECHNICAL DATA

Max. working pressure	1.0 MPa (10 bar)
Working temperature	Min. 5 °C/Max. 95 °C
Operating temperature	Min. 35 °C/Max. 65 °C
Thread standard	G - male thread
Media	Water - Glycol mixture max. 50% Ethanol mixture max. 30%
Material, valve body	Brass EN 12165 CW617N,DZR Brass EN 12165 CW625N
Temperature stability	±3°C

LK 551 HydroKit HWC is a compact unit for hot water circulation. Hot water circulation offers instantly available hot water at a tap, so you don't have to wait on hot water. Hot water circulation is especially useful in buildings with long water pipes.

LK 551 HydroKit HWC consists of a mixing valve, cross, connection kit and 3 check valves, to prevent self circulation. The mixing valve has a thermostat that regulates the supply of both cold and hot water to the desired temperature. The valve has an anti-scald function that closes for incoming hot water in case the cold water supply ends.

CAPACITY DIAGRAM

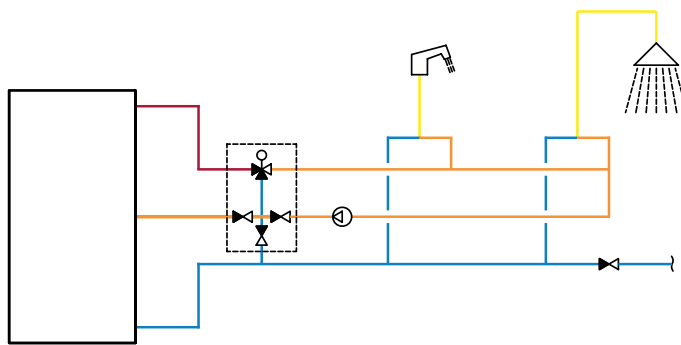
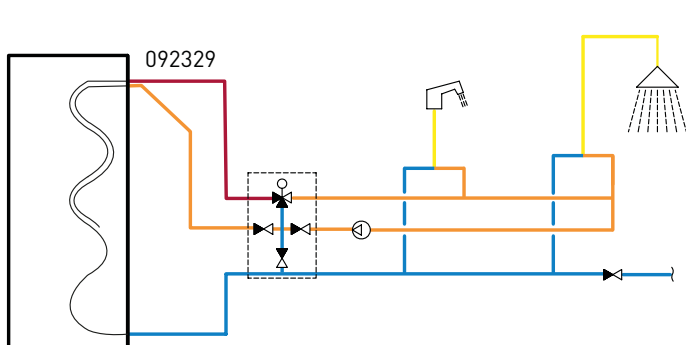
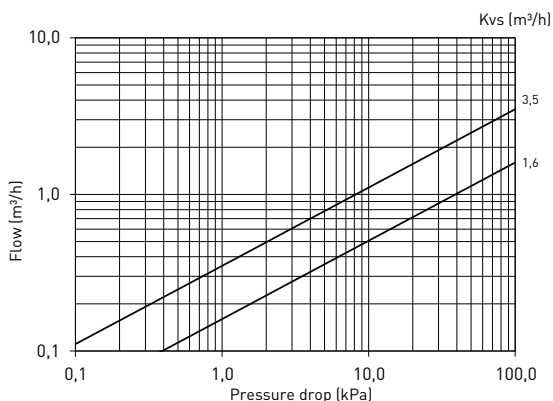

LK 551 HydroKit HWC

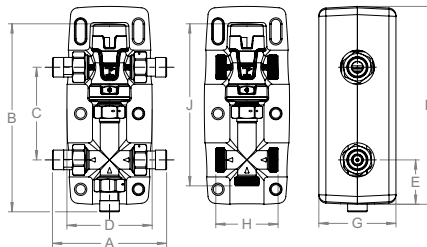

Article no.	Dim.	Kvs m ³ /h	A mm	B mm	C mm	D mm	E mm	F mm	G mm	H mm	J mm
091782	M 3/4"	1.6	140	205	81	115	60	225	104	70	170
182430	M 3/4"	3.5	154	250	125	120	70	270	110	84	217

* Material, valve body: EN 12165 CW617N

SPARE PARTS AND ACCESSORIES

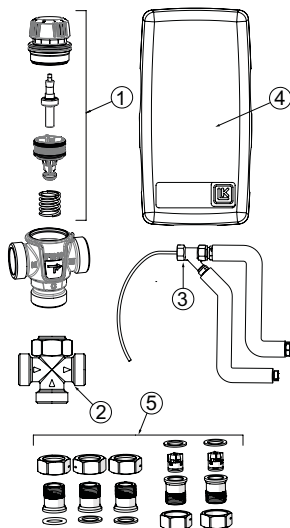

Article no.	Article	Position
095234	Repair kit 551, 35 - 65 °C (Kvs 1.6)	1
095350	Repair kit 551, 35 - 65 °C, Kvs 3.2-4.2	1
092325	Fitting	2
092329	LK CirculationKit HWC	3
092357	LK CirculationKit HWC, Kvs 3,5	3
187305	LK Insulation HWC (Kvs 1.6)	4
095460	LK Insulation HWC (Kvs 3.5)	4
095388	Connection kit M 3/4" x 1" with rotating nut, gaskets, 2 check valves	5

Circulation Kit

LK 551 HWC CirculationKit

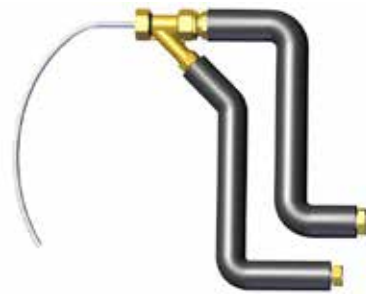

TECHNICAL DATA

Max. working pressure	0.6 MPa (6 bar)
Working temperature	Min. 5 °C/Max. 95 °C
Stainless steel pipe	EN 1008-3-14404 (AISI316L)
Pex	PE-Xc - PE-HD without EVOH Barrier
T-pipe	Cuphin

LK 551 HWC CirculationKit is an accessory for LK 551 HydroKit HWC. The accessory is installed when there is no connection for recirculated water in the tank.

It is installed on the hot water connection.

Using a pipe-in-pipe solution with a 1.5-metre Pex pipe, the return of recirculated water can be adjusted to a correct level to prevent the stratification in the tank from being destroyed.

Supplied with 2x insulated stainless steel pipes, valve and Pex pipe 8x1 length 1.5m.

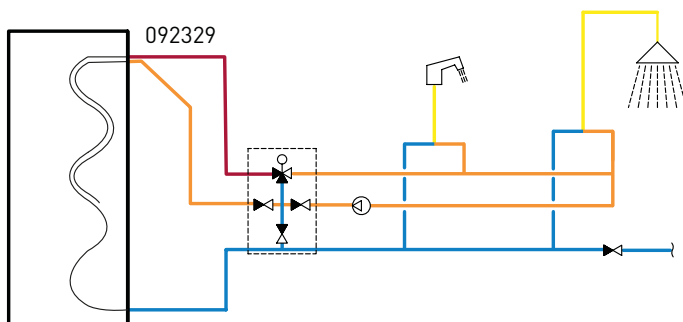

LK 551 HWC CirculationKit - Female thread

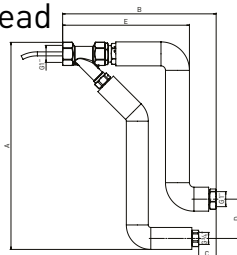

Article no.	Kvs m ³ /h	A mm	B mm	C mm	D mm	E mm	Weight kg
092329	1.6	415	308	35	79	254	2.1
092357	3.5	415	308	35	125	254	2.6

LK 551 HWC CirculationKit - Female thread

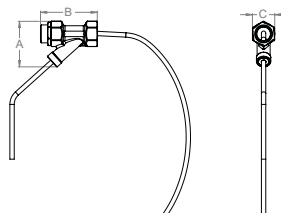

Article no.	Dim.	A mm	B mm	C mm	Weight kg
095487	M 1" x F 1" x M 3/4"	85	106	41	0.6

Mixing Valve

LK 552 HydroMix

- Scald protection
- Symmetrical
- Adjustable temperature



TECHNICAL DATA

Max. working pressure	1.0 MPa (10 bar)
Working temperature	Min. 5 °C/Max. 95 °C
Operating temperature	Min. 25 °C/Max. 45 °C Min. 35 °C/Max. 65 °C
Thread standard	Rp - female thread, G - male thread
Media	Water - Glycol mixture max. 50% Ethanol mixture max. 30%
Material, valve body	Brass EN 12165 CW617N
Temperature stability	±3 °C

LK 552 HydroMix is a mixing valve for water heating and heating systems. The mixing valve has a thermostatic element that regulates the supply of cold as well as hot water in order to achieve the desired temperature. The valve has an anti-scald function that shuts off the incoming hot water flow in case of failure of cold water supply.

Arrows on the valve body indicate the direction of the flow.

C = incoming cold water

H = incoming hot water

M = outgoing mixed water

When fitted on top of boiler/storage tanks with built-in water heaters the valve should be installed with some space between boiler/storage tank and valve so as not to let the function of the valve be affected by heat radiation.

The valve knob is used to set the desired warm water temperature within the specified range. The protective cap prevents unintentional changes of the temperature setting.

The valve requires no maintenance but the installation should be checked regularly.

CAPACITY DIAGRAM

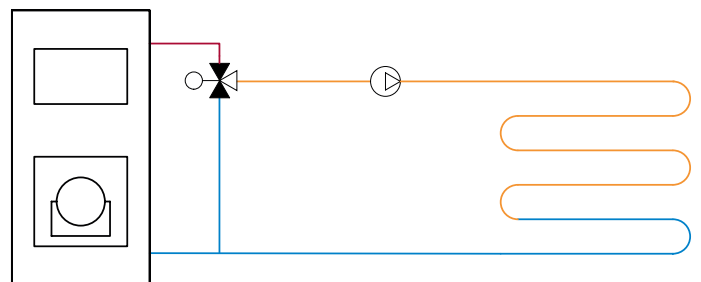
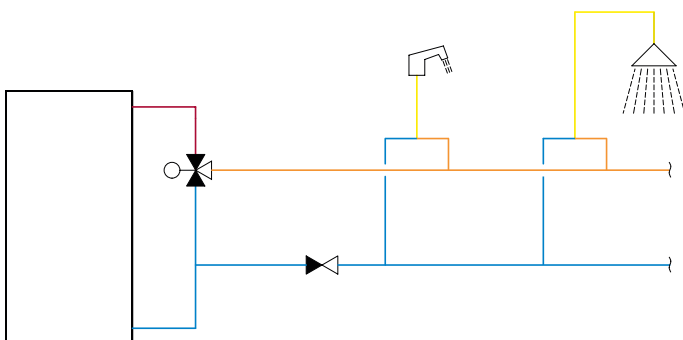
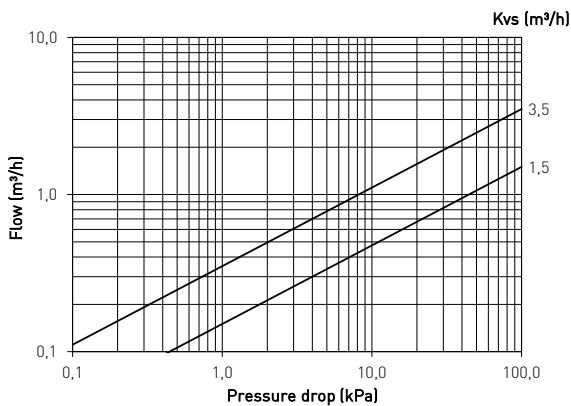

LK 552 - Female thread

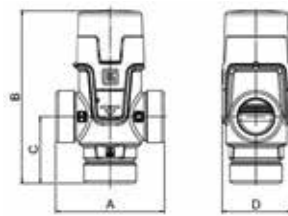

Article no.	Dim.	Kvs m ³ /h	A mm	B mm	C mm	D mm	Note	Weight kg
182234	F ¾"	1.5	70	110	42	45	35 - 65 °C	0.6
182237	F ¾"	1.5	70	110	42	45	25 - 45 °C	0.6
182256	F 1"	3.5	84	122	50	52	35 - 65 °C	0.9
182260	F 1"	3.5	84	122	50	52	25 - 45 °C	0.9

LK 552 - Male thread

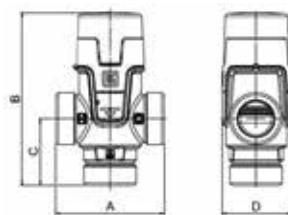

Article no.	Dim.	Kvs m ³ /h	A mm	B mm	C mm	D mm	Note	Weight kg
182235	M ¾"	1.5	70	110	42	45	35 - 65 °C	0.5
182236	M 1"	1.5	70	110	42	45	35 - 65 °C	0.6
182238	M ¾"	1.5	70	110	42	45	25 - 45 °C	0.5
182239	M 1"	1.5	70	110	42	45	25 - 45 °C	0.6
182257	M 1"	3.5	84	122	50	52	35 - 65 °C	0.7
182258	M 1¼"	3.5	84	122	50	52	35 - 65 °C	0.8
182261	M 1"	3.5	84	122	50	52	25 - 45 °C	0.7
182262	M 1¼"	3.5	84	122	50	52	25 - 45 °C	0.8

SPARE PARTS AND ACCESSORIES

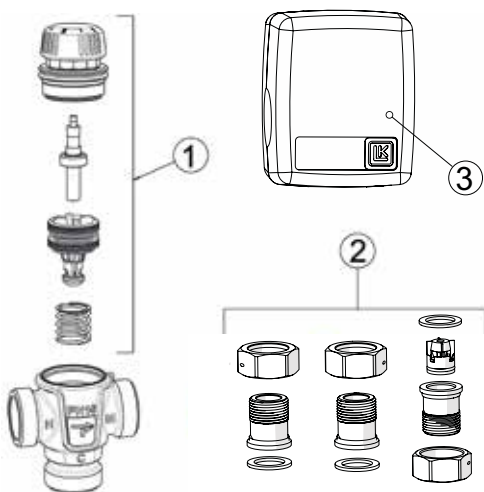

Article no.	Article	Position
095360	Repair kit 552, 25 - 45 °C	1
095361	Repair kit 552, 35 - 65 °C	1
095362	Repair kit 552, 25 - 45 °C (Kvs 3.5)	1
095363	Repair kit 552, 35 - 65 °C (Kvs 3.5)	1
092052	Connection kit M ¾" x 1" with rotating nut, gaskets, 1 check valve	2
092053	Connection kit M ¾" x 1" with rotating nut, gaskets, 2 check valves	2
092333	Connection kit M 1" x 1¼" with rotating nut, gaskets, 1 check valve	2
092334	Connection kit M 1" x 1¼" with rotating nut, gaskets, 2 check valves	2
187310	LK Insulation, 551 (Kvs 3.2-4.2) / 552	3



LK 450 EasyHeat P - The next generation of our portable electric boiler

LK 450 EasyHeat P is a complete portable electrically heated boiler. It is primarily intended to be used as a temporary heater, for example to dry concrete slabs installed with underfloor heating, or to heat buildings during construction.

LK Armatur now has a total of five different models of electric boiler in its extensive range.



The transport trolley is available to purchase as an accessory.



Products for Underfloor Heating

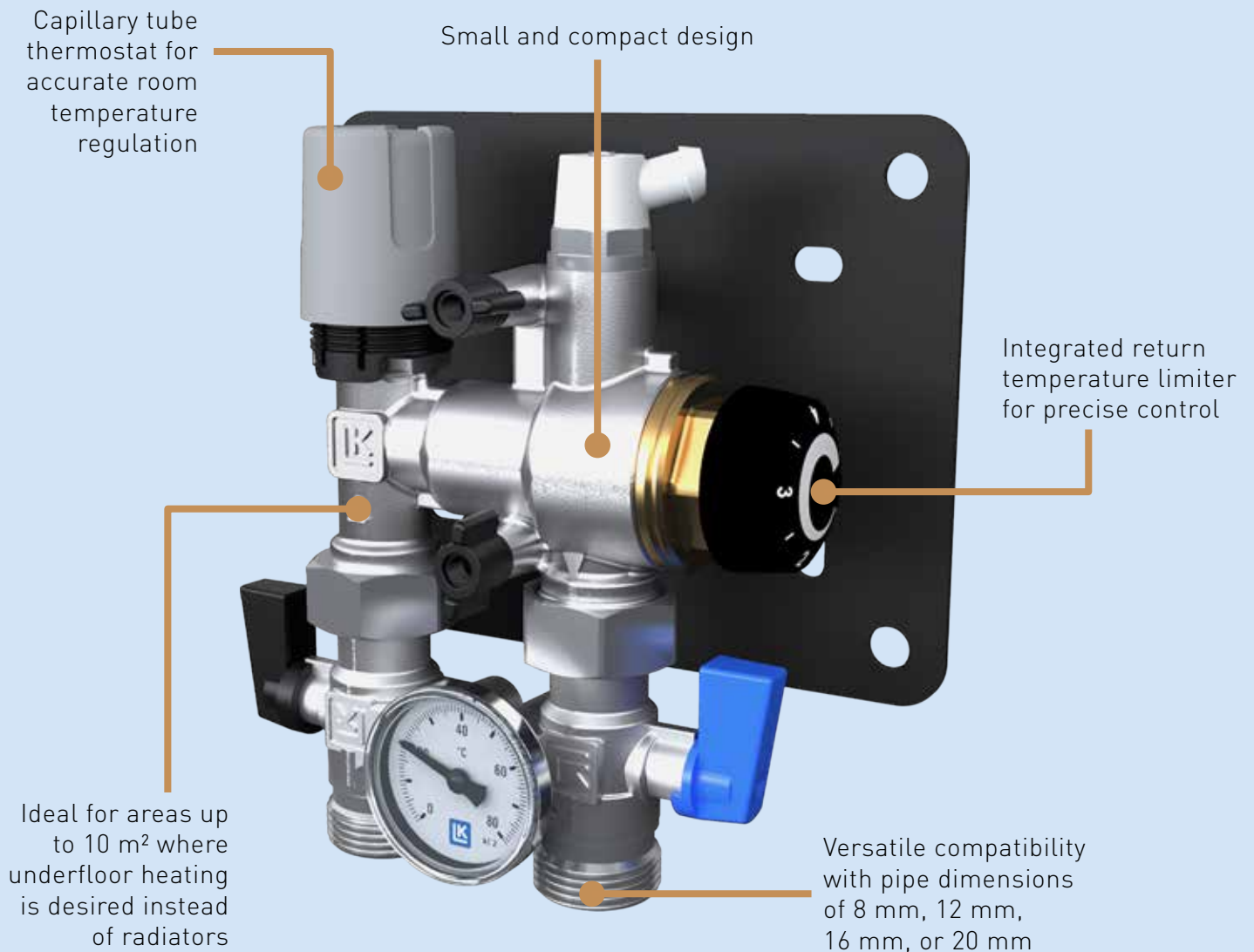

Keep your smaller underfloor heating systems under control with the **LK 423 MiniLoop RTC**. Designed for pipes of 8 mm, 12 mm, 16 mm, or 20 mm in concrete or leveling compound, it's got integrated return temperature limiting for surface temperature control. Room temperature is precisely managed with a capillary tube thermostat. Compact and ideal for areas up to 10 m².

Shunt Group

LK 419 Manifold Shunt



- Suitable for underfloor heating areas up to 200 m²
- Thermostat setting of supply temperature
- Choose between right and left installation



TECHNICAL DATA

Voltage	230 VAC 50/60 Hz
Power consumption	10-75 W, depending on pump speed
Max. working pressure	1.0 MPa
Working temperature	Min. 5 °C /Max. 95 °C
Media	Water - Glycol mixture max. 50%
Media 2	Water - Ethanol mixture max. 30%
Circulating pump	Grundfos UPM3 AUTO 15-70
Material, valve body	Brass EN 12165 CW617N
Material, supply pipe	Stainless steel EN 1.4404

LK 419 Manifold Shunt is a shunt group with a thermal mixing valve designed for systems equipped with a main pump.

The shunt group is suitable for both left-hand and right-hand mounting directly to LK Heat Circuit Manifold.

LK 419 is equipped with an asymmetric mixing valve, LK 551 HydroMix, that has a thermal insert that controls the supply of incoming and return pipe, so that the desired set temperature is achieved.

PUMP CHARACTERISTICS

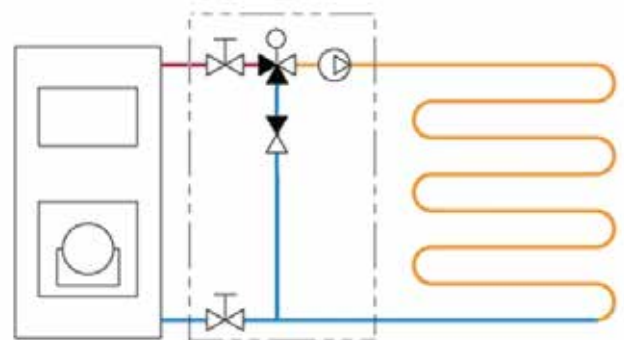
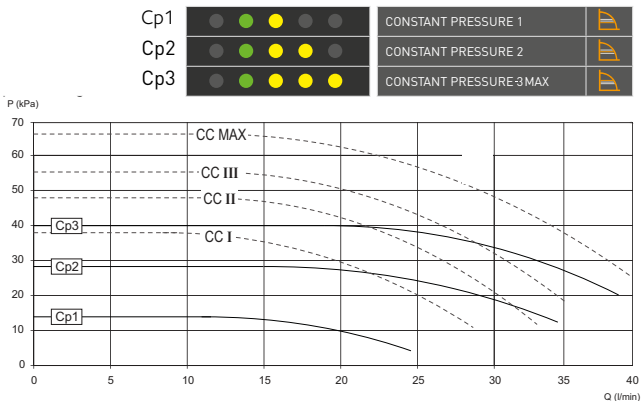

LK 419 - Male thread

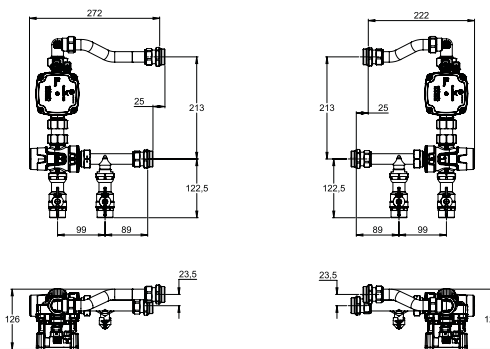

Article no.	Dim.	Kvs m ³ /h	Note	Weight kg
299451	M 1"	3.5	25 - 45 °C	4.6
299792	M 1"	3.5	35 - 65 °C	4.6

Shunt Group

LK 420 MiniShunt 2.0



- Switchable between single and two-pipe radiator systems
- Suitable for both left-hand and right-hand mounting



TECHNICAL DATA

Voltage	1 phase 230V+10%/-15%, 50/60 Hz, PE
Power consumption	Max 45 W
Max. working pressure	0.6 MPa (6 bar)
Max. differential pressure	0.1 MPa (1 bar)
Working temperature	Primary Max. 80 °C Secondary Min. 12 °C/Max. 55 °C
Ambient temperature	Max. 60 °C
Thread standard	Rp - female thread, G - male thread
Protection type	IP X4D
Media	Water - Glycol mixture max. 50% Ethanol mixture max. 30%
Material, valve body	Nickel-plated Brass EN 12165 CW617N
Circulating pump	Wilo Yonos PARA RSB 15/6-RKA
Max Valve capacity	Kvs 1.05
Max. valve capacity with selfacting thermostat installed.	Max. at room temperature approx. 20 °C Kv 0.9
Approved pump	CE, EC Low Voltage Directive (2006/95/EC) incl. additions

LK 420 MiniShunt 2.0 is a shunt group intended for use when smaller underfloor heating areas are to be connected to an existing heating system. LK MiniShunt adapts the heating system temperature to the lower temperature necessary for the underfloor heating system. Its capacity can normally be set at a heating need of 50 W/m² to a maximum 60 m² underfloor heating area. Capacity is however dependent on primary temperature, pressure, laying method etc.

- For underfloor heating areas up to 60 m².
- Compact design.
- Energy efficient circulation pump.
- Thermostat-controlled maximum limit of supply temperature.
- Switchable between single or twin pipe systems.
- VF valve.
- Easy filling and air bleeding.
- Expandable to 2, 3 or 4 underfloor heating circuits.

ITEMS INCLUDED

- Circulation pump Wilo Yonos Para RSB 15/6-RKA, with automatic speed control, 1 fas 230V AC, 50 Hz, max 45W, 0,44 A.
- Thermostat with capillary tube sensor, length 2 m.
- 1 thermometer to place in one of the shunt group's thermometer pockets.
- Hose 0.5 m for air bleeding.
- Primary connector G20 EK and 2 connectors for CU15.
- Bracket.

PUMP CHARACTERISTICS

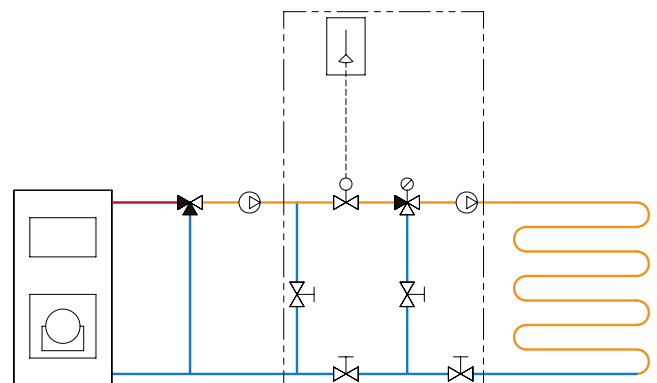
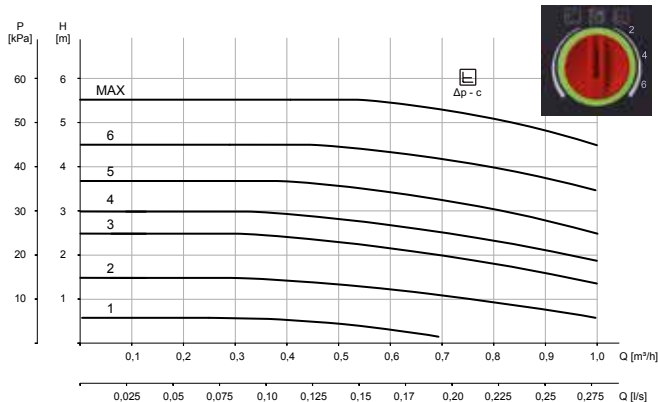

LK 420 - Compression fitting alt. Male thread / Female thread

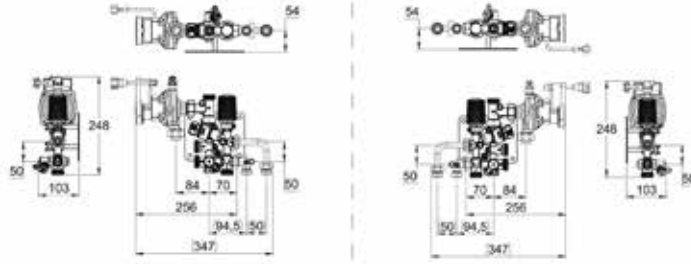

Article no.	Dim.	Kvs m ³ /h	Weight kg
299773	M 3/4" EuroCone / F 1/2"	1.05	4.0

Dimension = Prim. / Sec. connection

SPARE PARTS AND ACCESSORIES



Article no.	Article	Position
095442	Circulating pump Wilo PARA	1
095391	Thermostat with sensor	2

Shunt Group

LK 421 Manifold Shunt



- Suitable for left-hand and right-hand mounting



TECHNICAL DATA

Voltage	1 phase 230V AC, -15 %/+10 %, 50 Hz, PE
Power consumption	Max. 52 W
Max. working pressure	0.6 MPa (6 bar)
Max. differential pressure	0.1 MPa (1 bar)
Working temperature	Primary: Min. 5 °C/Max. 90 °C Secondary: Min. 30 °C/Max. 65 °C
Ambient temperature	Max. 70 °C
Thread standard	Rp - female thread, G - male thread
Protection type	IP44
Media	Water - Glycol mixture max. 50% Ethanol mixture max. 30%
Circulating pump	Grundfos UPM3 AUTO 15-70
Material, valve body	Nickel-plated Brass EN 12165 CW617N
Max. valve capacity control valve V1	Kv 2.2 (with hand actuator fitted)
Max. valve capacity control valve V1	Kvs 3.6 (with electric valve actuator)
Control valve V2	Kvs 4.1
Approved pump	CE, EC Low Voltage Directive (2006/95/EC) incl. additions

LK 421 is to be used in systems with main pump in the primary circuit. Its capacity can be set at a flat rate of heating requirements of 50W/m² to max 200 m² of floor heating surface. The capacity is dependent on the primary temperature, pressure, floor heating installing system, etc. The included supply pipe allows in both left- and righthand assembly to LK 430 Manifold RF. The shunt unit is a complete pre-manufactured unit.

ITEMS INCLUDED:

- Circulation pump Grundfos UPM3 Auto 15-70 130, with automatic speed control, 1 phase 230 V AC 50 Hz, max 45 W, 0.38 A
- Two way control valve Kvs value 2.5, equipped with hand actuator
- VF valve
- Temperature limiter of feed temperature
- Adjustment valve for the primary circuit
- Check valve
- 2 tube thermometers
- Isolation valves for primary circuit
- Fixing bracket

PUMP CHARACTERISTICS

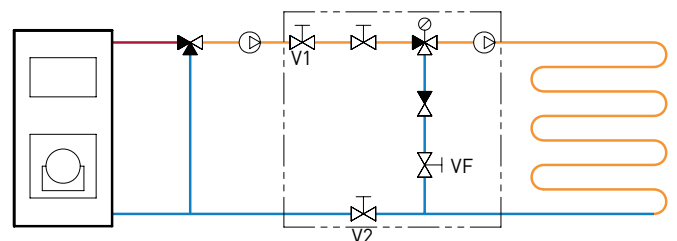
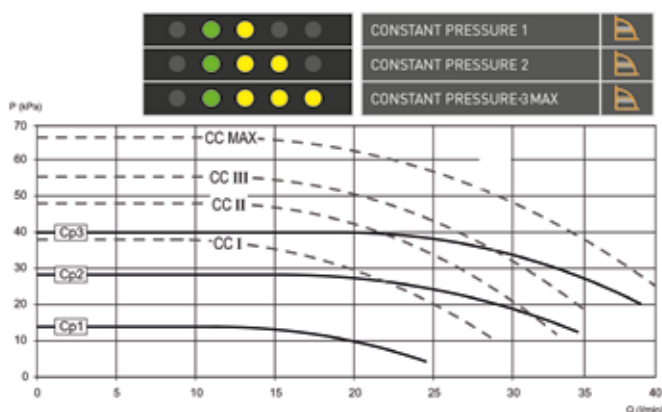

LK 421 - Female thread / Male thread

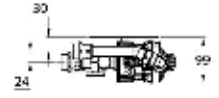
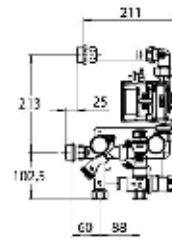
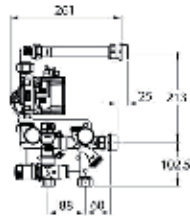

Article no.	Dim.	Weight kg
298559	F 3/4" / M 1"	4.6

Dimension = Prim. / Sec. connection

SPARE PARTS AND ACCESSORIES

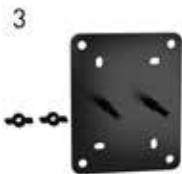

Article no.	Article	Position
187172	Circulating pump Grundfos UPM3 Auto 15/70	1
095018	Thermometer T40, 0 - 80 °C	2
095221	Bracket	3

Shunt Group

LK 422 Manifold Shunt Tmax



- Suitable for left-hand and right-hand mounting



TECHNICAL DATA

Voltage	1 phase 230V AC, -15 % / +10 %, 50 Hz, PE
Max. working pressure	0.6 MPa (6 bar)
Max. differential pressure	0.1 MPa (1 bar)
Working temperature	Primary: Min. 5 °C/Max. 90 °C Secondary: Min. 30 °C/Max. 65 °C
Ambient temperature	Max. 70 °C
Thread standard	G - male thread, G - female thread
Protection type	IP44
Media	Water - Glycol mixture max. 50% Ethanol mixture max. 30%
Circulating pump	Grundfos UPM3 AUTO 15-70
Material, valve body	Nickel-plated Brass EN 12165 CW617N
Material, supply pipe	Stainless steel EN 1.4404

LK Manifold Shunt Tmax is used in systems with a main pump. The shunt unit can be mounted directly to LK Manifold RF from the left or right. The shunt unit is fitted as standard with a constant thermostat controlled feed temperature as well as an automatic speed controlled pump for reduced energy consumption and quieter operation. The guideline capacity of this shunt unit is a maximum of 130 m² floor heating surface. The capacity is dependent on heat requirement, laying procedure etc.

LK 422 can be mounted directly onto the manifold from the right or left. A manifold supply pipe for use when mounting to the left of the manifold is supplied. When fitting from the right, shorten the supply pipe by about 50 mm, reposition the thermometers and the pump through 180°.

LK 422 requires no maintenance but the installation should be checked regularly.

PUMP CHARACTERISTICS

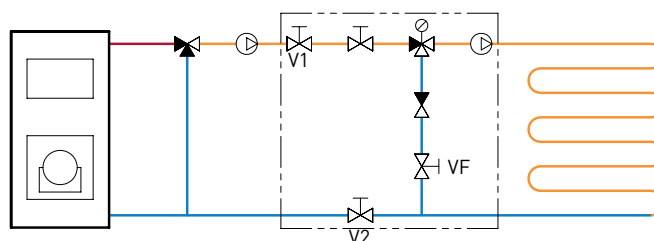
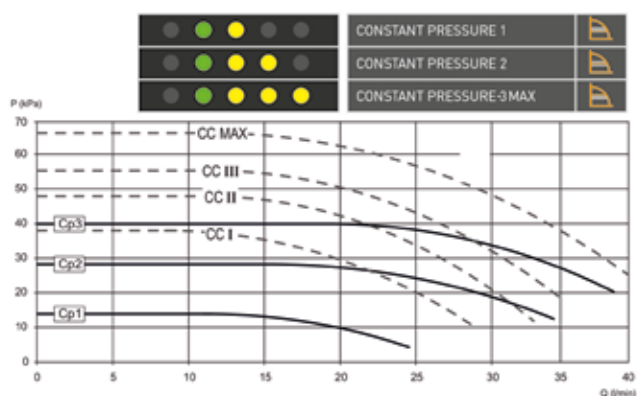

LK 422 - Female thread / Male thread

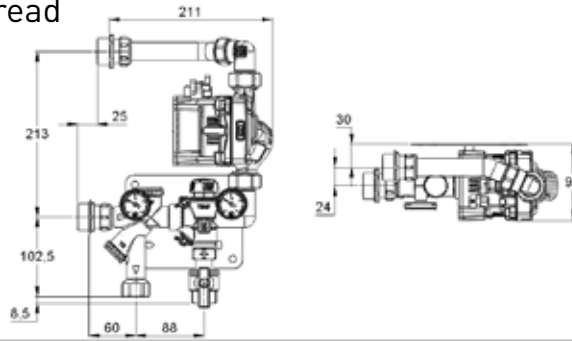

Article no.	Dim.	Kvs m ³ /h	Kvs2 m ³ /h	Weight kg
2419498	F 3/4" / M 1"	2.7	5,0	5.3

SPARE PARTS AND ACCESSORIES

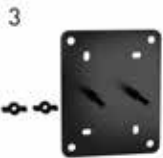

Article no.	Article	Position
187172	Circulating pump Grundfos UPM3 Auto 15/70	1
095018	Thermometer T40, 0 - 80 °C	2
095221	Bracket	3

Shunt Group

LK 423 MiniLoop RTC

- Small and compact
- Perfect for areas up to 10 m²



TECHNICAL DATA

Max. working pressure	0.6 MPa (6 bar)
Working temperature	Max. 55 °C
Media	Water - Glycol mixture max. 50%
Recommended max. underfloor heating surface installation	10 m ²
Return valve adjustment range	23 - 44 °C
Thermostat adjustment range	6 - 28 °C
Capillary tube length	2 m
Diameter capillary tube bulb	∅ 16 m

LK 423 MiniLoop RTC is designed to control smaller under floor heating systems that are embedded in concrete or levelling compound with a pipe dimension of 8 mm, 12 mm, 16 mm or 20 mm.

LK 423 MiniLoop RTC has integrated return temperature limiter that make it possible to limit the floor surface temperature.

The room temperature is regulated via a capillary tube thermostat.

- A. Radiator
- B. Radiator system, supply
- C. Radiator system, return
- D. Floor heating circuit
- E. LK 423 MiniLoop RTC
- F. Return pipe, floor heating circuit (from RTC)
- G. Connection point, supply floor heating circuit
- H. Connection point, return floor heating circuit (from RTC)

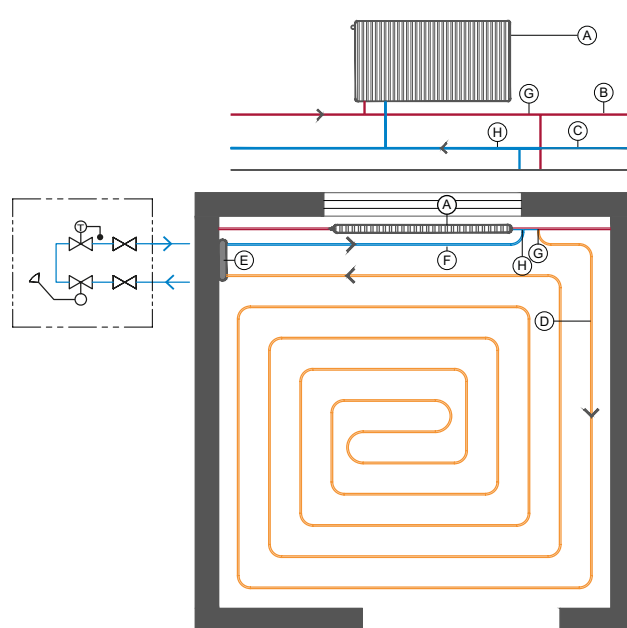
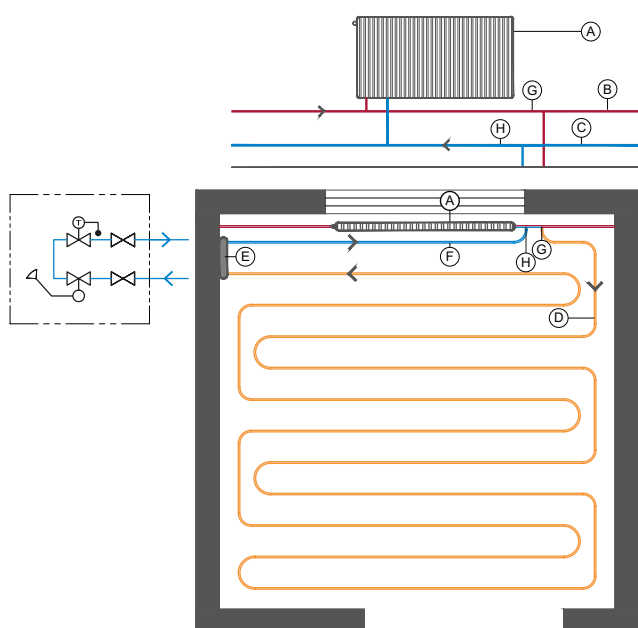

LK 423 - Male thread

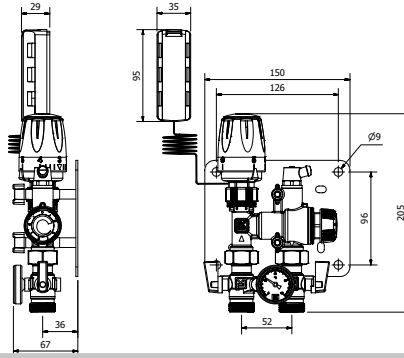

Article no.	Dim.	Kvs m ³ /h	Weight kg
299355	¾" Eurocone	1.48	0.4

SPARE PARTS AND ACCESSORIES

	Article no.	Article	Position
1.	095391	Thermostat with sensor	1
	2988856	LK Installation cabinet RTB	2
	1882348	LK Frame/hatch	3
2.			
3.			

Manifold

LK 430 Manifold

- For up to 12 circuits
- Stainless steel



TECHNICAL DATA

Max. working pressure	1.0 MPa (10 bar)
Max. differential pressure	100 kPa (1 bar)
Working temperature	Min. 5 °C/Max. 70 °C (max. 85 °C briefly)
Ambient temperature	Min. -20 °C/Max. 40 °C
Thread standard	G - female thread, G - male thread
Media	Water
Media 2	Water - Ethylene glycol mixture max. 50%
Media 3	Water - Propylene glycol mixture max. 50%
Media 4	Water - Ethanol mixture max. 50%
Flow indication	Scale 0.5 - 5 l/min. ±10%
Thermometer	0 - 80 °C
Material, manifold	Stainless steel EN 10088-3 1.4306
Material, threaded union parts/isolation valves	Nickel plated brass EN 12165 CW617N

LK 430 is a manifold for 2 - 12 underfloor heating circuits. It is manufactured in stainless steel and is delivered pre-mounted to a bracket. The manifold is equipped with filling / drainage valves. The upper manifold marked FLOW is fitted with flow indicators and adjustment valves for setting the respective circuit flows. The lower manifold marked RETURN has manually operated valves for shutting off each respective circuit. These valves are normally replaced with thermoelectric actuators. Thermometers for the return and flow manifolds are available - see under Accessories.

LK 430 can also be supplied with an LK 435 OptiFlow balancing valve for easy adjustment of the circuit flow. The flow rate is clearly indicated on a transparent scale - see under Accessories. For more information see the product sheet for OptiFlow.

The heat supply can be connected to the manifold from the left or the right side. The manifold is delivered ready for connection from the left. When connecting from the right, reposition the drainage valves.

LK 430 requires no maintenance but the installation should be checked regularly.

VALVE CHARACTERISTICS

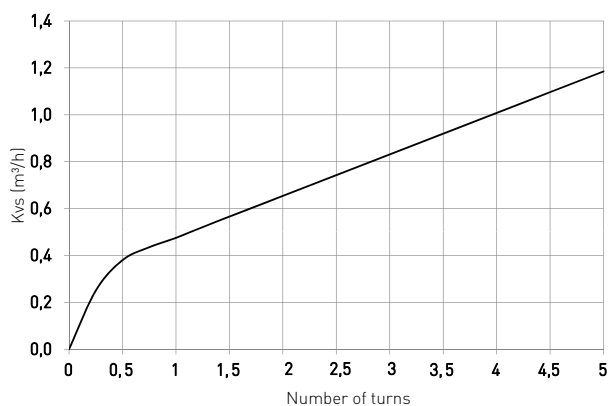

LK 430 - Female thread / Male thread

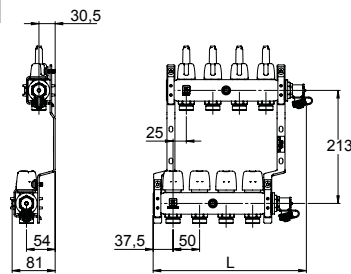
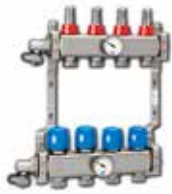

Article no.	Dim.	Dim. 2	Dim. 3	Kvs m ³ /h	Kvs2 m ³ /h	No. of circuits	L mm	Weight kg
297311	F 1"	M 3/4" EuroCone	M 1/2"	1.1	2,5	2	190	2.8
297312	F 1"	M 3/4" EuroCone	M 1/2"	1.1	2,5	3	240	3.2
297313	F 1"	M 3/4" EuroCone	M 1/2"	1.1	2,5	4	290	3.6
297314	F 1"	M 3/4" EuroCone	M 1/2"	1.1	2,5	5	340	4.2
297315	F 1"	M 3/4" EuroCone	M 1/2"	1.1	2,5	6	390	4.7
297316	F 1"	M 3/4" EuroCone	M 1/2"	1.1	2,5	7	440	5.1
297317	F 1"	M 3/4" EuroCone	M 1/2"	1.1	2,5	8	490	5.7
297318	F 1"	M 3/4" EuroCone	M 1/2"	1.1	2,5	9	540	6.0
297319	F 1"	M 3/4" EuroCone	M 1/2"	1.1	2,5	10	590	6.5
297320	F 1"	M 3/4" EuroCone	M 1/2"	1.1	2,5	11	640	7.0
297321	F 1"	M 3/4" EuroCone	M 1/2"	1.1	2,5	12	690	7.5

SPARE PARTS AND ACCESSORIES



Article no.	Article	Position
095018	Thermometer T40, 0 - 80 °C	1
090275	LK 435 OptiFlow, 2-16 l/min	2
090276	LK 435 OptiFlow, 4-36 l/min	2
095182	Drainage valve	3
095178	Return valve	4
095346	Adjustment valve, supply	5

Flow Adjustment Valve



LK 435 OptiFlow

- With MemoStop for locking setting
- Adjusted with Allen key while reading off flow on a clear scale



TECHNICAL DATA

Max. working pressure	1.0 MPa (10 bar)
Max. differential pressure	100 kPa (1,0 bar)
Working temperature	
Water/Glycol 50/50%	Min. -20 °C / Max. 80 °C (90 °C briefly)
Water/Ethanol 70/30%	Min. -20 °C / Max. 70 °C (85 °C briefly)
Media	Water - Glycol mixture max. 50% Ethanol mixture max. 30%
Material, valve body	Nickel-plated Brass EN 12165 CW617N
Flow ranges	2-16 l/min, 4-36 l/min
Accuracy, flow meter:	+/- 12%
Thread standard, adjustment valve inlet:	M - male thread
Thread standard, adjustment valve outlet:	F - female thread

LK 435 OptiFlow is a group valve for flow adjustment of hydraulic systems such as underfloor heating, traditional heating and cooling systems. Adjustments are easily made using an Allen key. No measuring equipment is needed. The flow rate is read off directly from the visual flow indicator. The flow meter continuously measures and displays the actual flow rate during operation.

LK 435 OptiFlow has a MemoStop function for locking the setting. This means that the valve can be used as a shut-off valve without losing settings. A marking plate for labelling and documenting the setting is enclosed. LK 435 OptiFlow can be supplemented with a thermometer and threaded union parts, straight or angular, with rotating nut for simple assembly to, for example, an LK 430 Manifold RF - see under Accessories. The thermometer is placed in the valve's integrated sensor pocket.

The valve can be mounted in any position. The arrow on the valve body indicates the flow direction. For accurate measurement a straight piece of tube at least of the same length as the valve body should precede the balancing valve. When assembling to an LK 430 Manifold RF the adjustment valve can be fitted directly to the manifold, thus replacing the shut-off valve.

The flow meter is designed so that the fluid does not flow through the glass in order to protect it from debris and dirt. However, after a period of time the glass may still have to be cleaned as the fluid often becomes contaminated and blackened. It is then easy to remove the glass to clean it. The function/setting of the valve is not affected by deposits in the glass.

Except for cleaning of the glass, the group valve normally requires no maintenance. The installation should be checked regularly.

VALVE CHARACTERISTICS

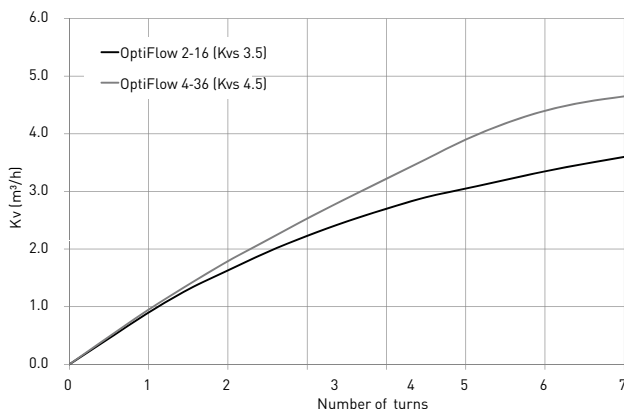

WITH LK 430 MANIFOLD RF

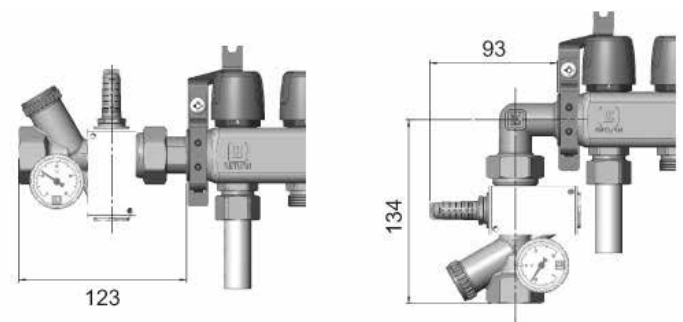

LK 435 - Male thread / Female thread

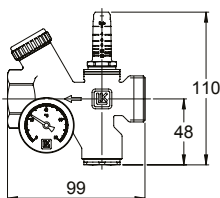

Article no.	Dim.	Kvs m ³ /h	Flow range	Weight kg
090275	Adjustment valve - M 1" / F 1"	3.5	2-16 l/min	0.5
090276	Adjustment valve - M 1" / F 1"	4.5	4-36 l/min	0.5

SPARE PARTS AND ACCESSORIES

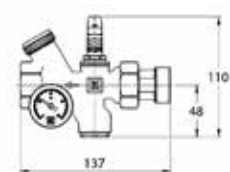

Article no.	Article	Position
095222	Threaded union part straight M 1" with rotating nut	1
095223	Threaded union part angle M 1" with rotating nut	2
095018	Thermometer T40, 0 - 80 °C	3

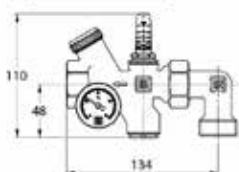

Portable Boiler

LK 440 EasyHeat

- Complete portable electrically heated boiler
- Available in 3 kW and 9 kW
- Easy installation



TECHNICAL DATA

Protection class	IP 44
Circulating pump	Grundfos UPM3 AUTO
Operating thermostat	Max 60 °C
Safety thermostat	80 °C
Expansion tank	12 l
Safety valve	3 bar
Max. glycol solution	30%
Boiler volume	2.8 l



The LK 440 EasyHeat is a complete portable electrically heated boiler. It is primarily meant to be used as a temporary heater, e.g. for drying concrete slabs installed with under floor heating and for heating buildings under construction.

LK 440 EasyHeat is available in two versions, with 3-phase 400V or 1-phase 230V. The total output capacity on 3-phase 400V is 9 kW and works in two steps of 4.5 kW. The total output capacity on 1-phase 230V can be manually set between 2 or 3 kW.

The boiler is supplied complete with a circulation pump, an expansion tank, and auxiliary devices including a safety valve and air vent valve. Connection to the under floor heating manifold or heating system is simple, using steel-reinforced flexible hoses. Temperature regulation is controlled by the boiler's operating thermostat.

ELECTRIC CONNECTION DIAGRAM, MODEL 298 588

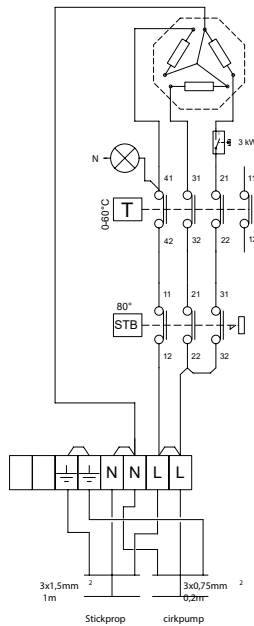

CAPACITY DIAGRAM

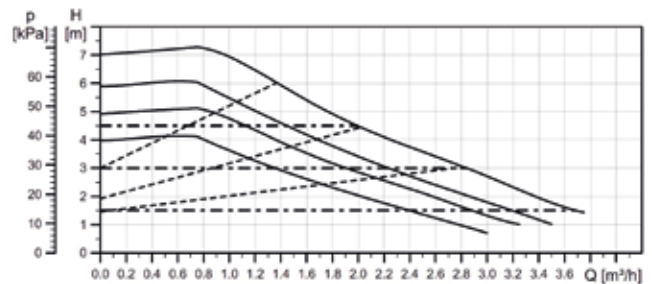

LK 440



Art.no.	Dim.	Connection	Voltage	B mm	H mm	L mm	Safety thermostat	Weight kg
298470	F 1"	3-phase 400 V Boiler must be protected using 3 x 16 A fuses (max. current 13.5 A)	9 kW in two stages at 4.5 kW	430	650	710	80 °C	30.0
298588	F 1"	1-phase 230V Boiler must be protected using 8,5 A 2 kW, 13 A 3 kW	2 alt. 3 kW	430	650	710	80 °C	30.0

Electric portable boiler

LK 450 EasyHeat P

- Portable
- Water level detection
- Lockable cabinet



TECHNICAL DATA

Voltage	400 V
Primary voltage, adapter	400 V
Max. boiler efficiency	9 kW (3 + 6 kW)
Sound level	<30 dB
Max. working pressure	3 bar
Working temperature	8-60 °C
Min. supply temperature	8 °C
Max. supply temperature	60 °C
Thread standard	G - female thread
Protection type	IP44
Media	Water - Glycol mixture max. 30%
Electrical connection	CEE-socket 400 V/16 A 5-pole
Circulating pump	Wilo Para 15/6 - Composite
Antifreeze function	Yes
Level guard	Yes
Expansion vessel	6 l
Overheating protection	80 °C
File import / export	Micro SD-card (not included)



The LK 450 EasyHeat P (programmable) 9 kW is a complete portable electrically heated boiler. It is primarily meant to be used as a temporary heater, e.g. for drying concrete slabs installed with under floor heating or for heating buildings under construction.

The temperature can be set between 8 and 60°C.

With the LK 450 EasyHeat P 9 kW, setting individual drying period programs is possible.

60 individual heating steps enable full control of the drying process and to receive a report on process afterwards if a micro SD-card is used.

When a program is finished, the boiler maintains a supply temperature of 8 °C to avoid risk of freezing.

With its built-in water level detection, damage to the immersion heater is prevented if the water level in the system gets too low.

A constant temperature can be set when used as a temporary electric boiler.

EasyHeat comes in a blue aluminum cabinet with inspection window, so you can monitor the unit during operation. The cabinet can be locked to prevent accidental changes to the set temperature.



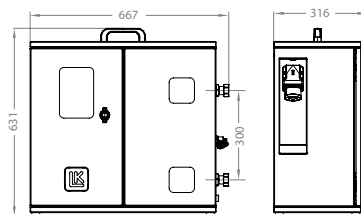

The LK 321 MultiFill® is available as an accessory, and makes it easy to fill the system. The LK 522 filter ball is used to protect EasyHeat from dirt and magnetite. Transport trolley to simplify moving unit. Connection pipes for easy connection between EasyHeat and the heating system. Refer to Accessories & Spare parts.

450 EasyHeat P - 9kW



Article no.	Dim.	Voltage	Weight kg
299529	F 1"	400 V	<25kg

SPARE PARTS AND ACCESSORIES

	Article no.	Article	Position
1. 	187354	Wilo Para 15/6 - Composite	1
2. 	187352	Transport trolley	2
3. 	187353	2 pcs. flexible hoses 1" F x 1" M, 1,5 m	3
4. 	092320	LK 321 MultiFill®	4
5. 	182437	LK 522 FilterBall Magnet	5

Electric portable boiler

LK 450 EasyHeat M

- Portable
- Water level detection
- Lockable cabinet



TECHNICAL DATA

Voltage	3 kW: 230 V 9 kW: 400 V
Primary voltage, adapter	3 kW: 230 V 9 kW: 400 V
Max. boiler efficiency	3 kW (1,5 + 1,5 kW) 9 kW (3 + 6 kW)
Sound level	<30 dB
Max. working pressure	3 bar
Working temperature	8-60 °C
Min. supply temperature	8 °C
Max. supply temperature	60 °C
Thread standard	G - female thread
Protection type	IP44
Media	Water - Glycol mixture max. 30%
Electrical connection	3 kW: CEE 16 A/230 V/50 Hz/1~ 1-Phase 9 kW: CEE-socket 400 V/16 A 5-pole
Circulating pump	Wilo Para 15/6 - Composite
Antifreeze function	Yes
Level guard	Yes
Expansion vessel	6 l
Overheating protection	80 °C
File import / export	SD-card



The LK 450 EasyHeat M (manual) 3 kW or 9 kW is a complete portable electrically heated boiler. It is primarily meant to be used as a temporary heater, e.g. for drying concrete slabs installed with underfloor heating or for heating buildings under construction.

With the LK 450 EasyHeat M, setting the required constant temperature between 8 and 60°C is easy.

The LK 450 EasyHeat is available in two versions: single phase 230 V with 3 kW output or 3-phase 400 V with 9 kW output. With its built-in water level detection, damage to the immersion heater is prevented if the water level in the system gets too low.

EasyHeat comes in a blue aluminum cabinet with inspection window, so you can monitor the unit during operation. The cabinet can be locked to prevent accidental changes to the set temperature.

The LK 321 MultiFill® is available as an accessory, and makes it easy to fill the system. The LK 522 filter ball is used to protect EasyHeat from dirt and magnetite. Transport trolley to simplify moving unit. Connection pipes for easy connection between EasyHeat and the heating system. Refer to Accessories & Spare parts.

LK 450 EasyHeat M - 3kW

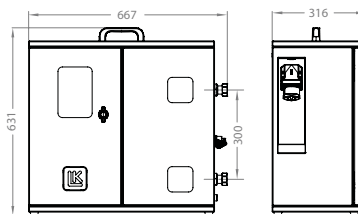



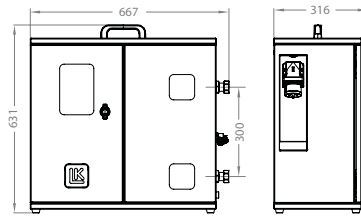

Article no.	Connection	Voltage	Weight kg
299742	1"	230 V	<25

LK 450 EasyHeat M - 9 kW



Article no.	Connection	Voltage	Weight kg
299748	1"	400 V	<25

SPARE PARTS AND ACCESSORIES

	Article no.	Article	Position
1. 	187354	Wilo Para 15/6 - Composite	1
2. 	187352	Transport trolley	2
3. 	187353	2 pcs. flexible hoses 1" F x 1" M, 1,5 m	3
4. 	092320	LK 321 MultiFill®	4
5. 	182437	LK 522 FilterBall Magnet	5



LK 522 FilterBall

LK 522 FilterBall is a ball valve with an integrated filter suitable for heating, cooling and tap water systems.

Smart design - No leakage if you happen to open the valve

- With or without handle
- With or without magnet - For collecting magnetite



Other Products

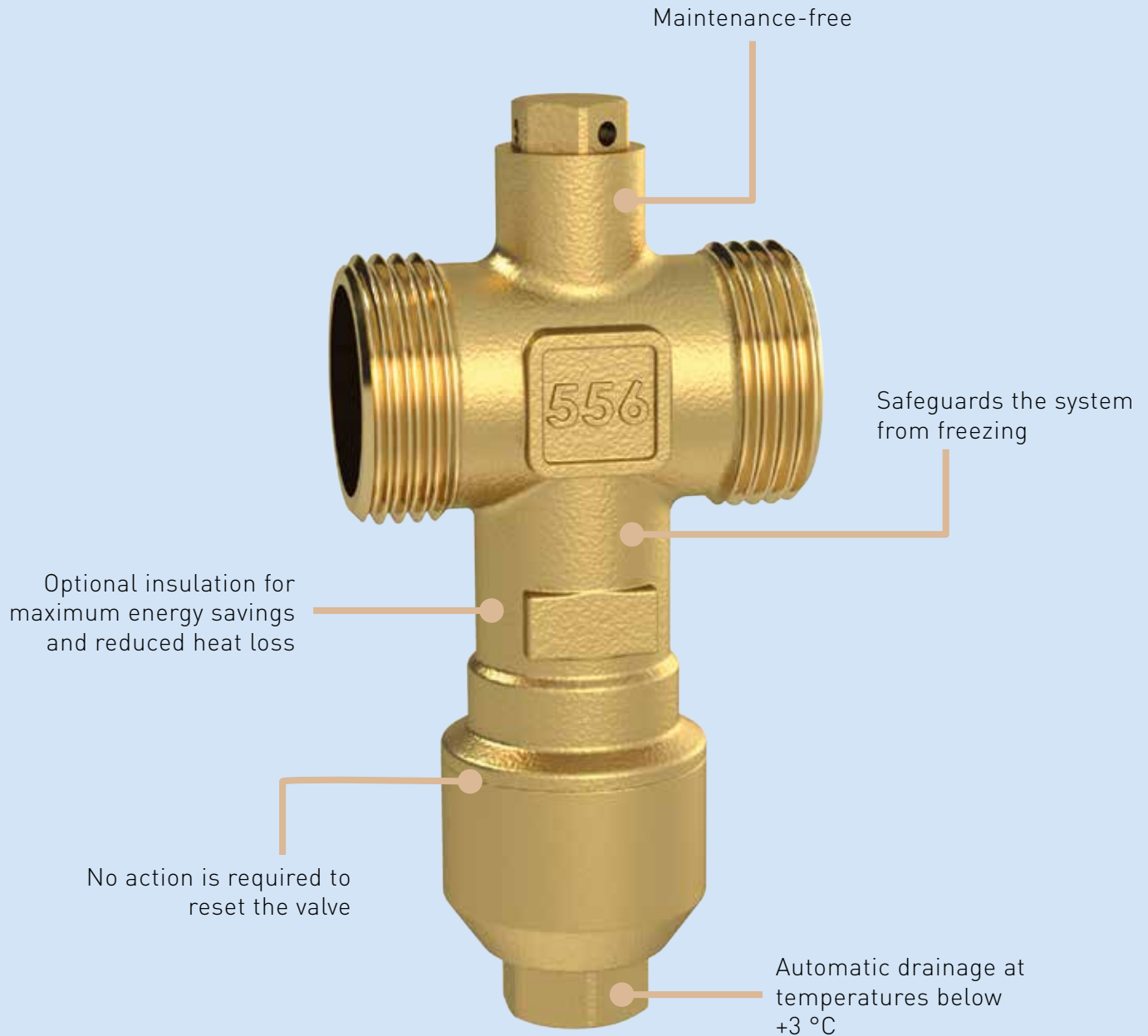

Protect your heating system from freezing with the **LK 556 AntiFreeze**. Designed for air/water heat pumps, it automatically drains the system if temperatures dip below +3°C, ensuring your heating system remains safe and operational. Boost energy efficiency with available insulation, and enjoy the benefits of a maintenance-free valve.

Ball Valves

LK 315 Ball Valve

- Low pressure drop
- Thermometer pocket



TECHNICAL DATA

Max. working pressure	1.0 MPa (10 bar)
Working temperature	Min. -20/Max. 110 °C
Thread standard	Rp - female thread, G - male thread
Media	Water - Glycol mixture max. 50% Ethanol mixture max. 30%
Material, valve body	Brass EN 12165 CW617N
Material, sealing	PTFE
Spindle sealing	EPDM

Ball valve for heating systems. The valve has a 2" rotating nut on one side, for an easy connection on e.g. a circulating pump. A sensor pocket is integrated in the valve body. Thermometer 181736 is available as an accessory.

LK 315 - Female thread

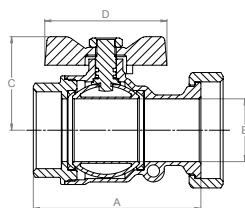

Article no.	Dim.	A mm	B mm	C mm	D mm	Weight kg
055840	F 2", rotating nut / F 1½"	98.5	37	55.5	72	0.9

LK 315 - Female thread / Male thread

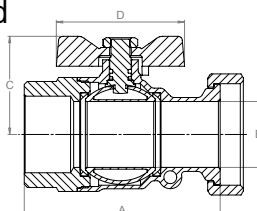

Article no.	Dim.	A mm	B mm	C mm	D mm	Weight kg
055841	F 2", rotating nut / M 2"	110	37	55.5	72	1.2

LK 315 - Female thread

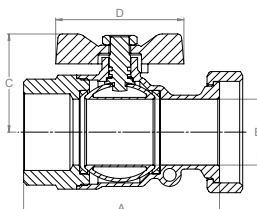

Article no.	Dim.	A mm	B mm	C mm	D mm	Weight kg
055842	F 2", rotating nut / F 2"	101.5	37	55.5	72	1.0

SPARE PARTS AND ACCESSORIES

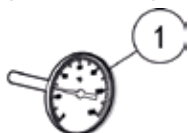

Article no.	Article	Position
181736	Thermometer 120 °C	1

Cyclone filter

LK 360 NetMag

- Extend the service life of your heating system
- Energy-saving
- Rotatable filter housing, can be installed vertically and horizontally



TECHNICAL DATA

Max. working pressure	0.4 MPa (4 bar)
Working temperature	0-90 °C
Thread standard	G - female thread, ISO 228/1
Media	Water - Glycol mixture max. 30%
Material, valve body	Nickel-plated Brass EN 12165 CW617N
Filter housing	Polyamide PA66
Ball valve	Nickle-plated brass CW617N
Magnet	Neodymium 11,000 gauss

The LK 360 NetMag is a magnetic cyclone filter that effectively protects your boiler and other components in your heating system by collect dirt and magnetite.

LK 360 shall be installed on the return pipe at the boiler inlet to protect the boiler from contamination. The filter housing is rotatable and can be installed vertically or horizontally, making it suitable for most spaces.

PRESSURE DROP DIAGRAM

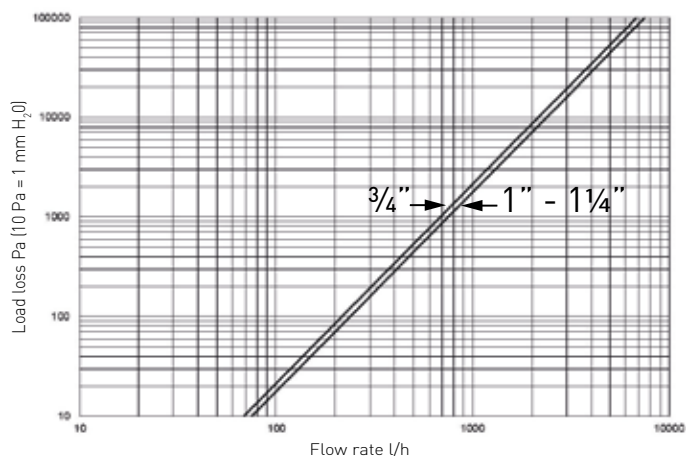

LK 360 - Female thread

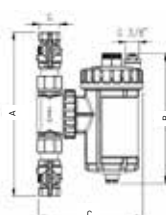

Article no.	Dim.	DN	Kvs m ³ /h	A mm	B mm	C mm	Weight kg
50801619	F 3/4"	20	6.81	237	189	153	1.2
50801620	F 1"	25	7.51	253	189	153	1.3
50801621	F 1 1/4"	32	7.51	256	189	153	1.3

Safety valves

LK 519 ThermoSafe

- Protect your boiler against overpressure
- Protective flexible hose for capillary tube



TECHNICAL DATA

Max. working pressure	1.0 MPa (10 bar)
Working temperature	Min. 5 °C/Max. 110 °C
Opening temperature	97±2 °C
Thread standard	Rp - female thread, G - male thread
Material, valve body	Brass EN 12165 CW617N
Material, sealing	Viton
Max. discharge capacity	6,5 m³/h at 0,6 MPa (6 bar) : :
Material, spring	Stainless steel
Material, capillary pipe	Copper, length 1300 mm, with insulation



LK 519 ThermoSafe is a thermal safety valve for solid fuel boilers with built-in water heaters or cooling coils. The safety valve prevents the temperature of the boiler water from rising above the boiling point. When temperature levels are too high the valve opens to let cold water flow through water heater or cooling coil, thus reducing the temperature of the boiler. LK 519 ThermoSafe has two, separately functioning, temperature sensors for added safety.

LK 519 ThermoSafe safety valve is installed on the outlet pipe of water heaters. The inlet pipe is recommended for cooling coils as such an installation would protect the armature from impurities caused by lime scale and other deposits.

The arrow on the valve housing indicates the direction of the flow. The sensor pocket is screwed into the designated connection on the boiler. It is easier to install if the sensors are first removed from the pocket.

VALVE CHARACTERISTICS

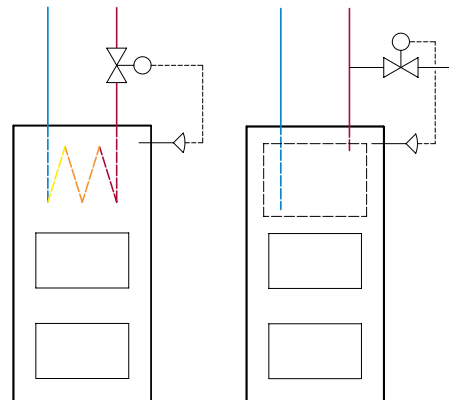
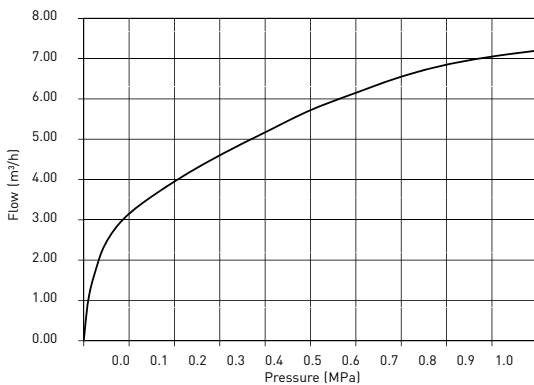

LK 519 - Female thread

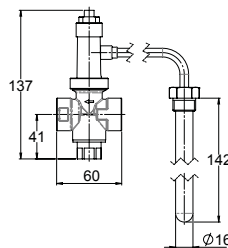

Article no.	Dim.	A mm	B mm	C mm	D mm	Weight kg
091777	F 3/4" / M 1/2"	120	41	60	142	0.7

Filter Ball Valve

LK 522 FilterBall

- DZR Brass
- Easy to clean the filter



TECHNICAL DATA

Max. working pressure	1.6 MPa (16 bar)
Working temperature	Min. -20 °C/Max. 120 °C
Mesh opening, filter	0.7 mm / 0.5 mm
Thread standard	ISO 228/1
Media	Water - Glycol mixture max. 50%
Material, valve body	DZR Brass EN 12165 CW625N
Material, filter element	Stainless Steel
Material, sealing	PTFE
Material, cover sealing	EPDM
Spindle sealing	Two O-rings, EPDM

LK 522 FilterBall is a ball valve with an integrated filter suitable for heating, cooling and tap water systems.

The filter is easy to clean, just close the ball valve, unscrew the lid and remove the filter.

The valve requires no maintenance, but the installation should still be checked regularly.

CAPACITY DIAGRAM - 0,7 MM

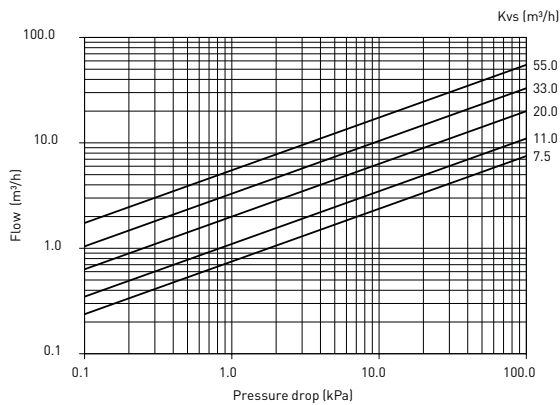

CAPACITY DIAGRAM - 0,5 MM

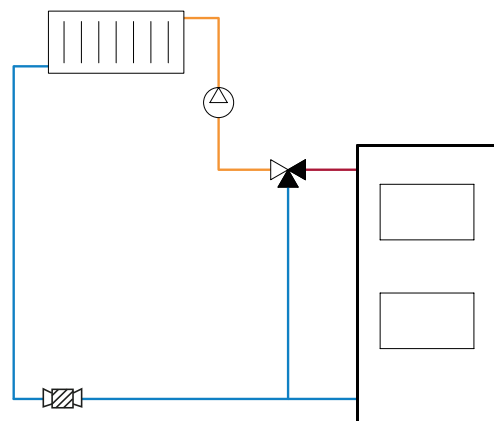
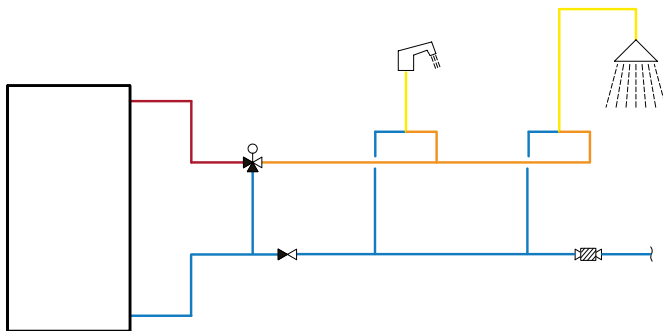
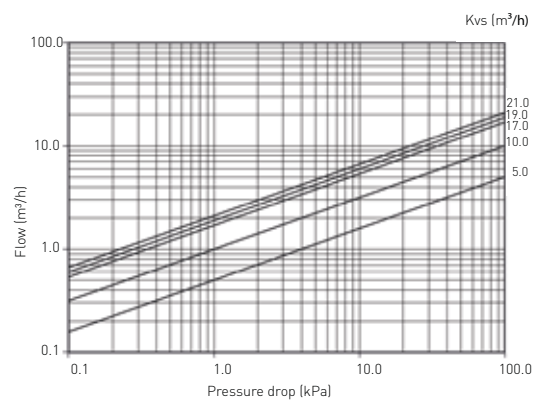

LK 522 - Female thread

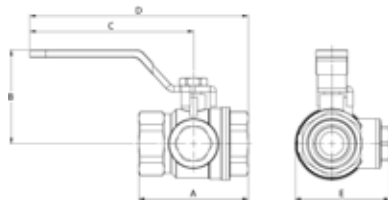

Article no.	Dim.	Kvs m ³ /h	A mm	B mm	C mm	D mm	E mm	Note	Weight kg
182015	F 3/4"	7,5	60	55	87	117	51	Mesh opening filter: 0.7 mm	0.3
182016	F 1"	11,0	71	60	107	142	61	Mesh opening filter: 0.7 mm	0.5
182017	F 1 1/4"	20,0	84	65	107	149	75	Mesh opening filter: 0.7 mm	0.9
182018	F 1 1/2"	33,0	93	80	143	189	88	Mesh opening filter: 0.7 mm	1.3
182019	F 2"	55,0	119	90	143	203	105	Mesh opening filter: 0.7 mm	2.1

LK 522 - Male thread

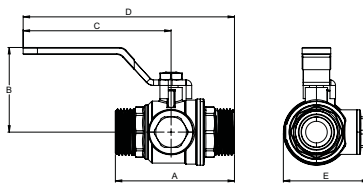

Article no.	Dim.	Kvs m ³ /h	A mm	B mm	C mm	D mm	E mm	Note	Weight kg
182432	M 3/4"	5,0	74	55	87	126	51	Mesh opening filter: 0.7 mm	0.4
182433	M 1"	10,0	85.5	60	107	153	61	Mesh opening filter: 0.7 mm	0.6

LK 522 without handle - Female thread

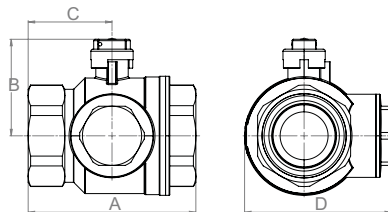

Article no.	Dim.	Kvs m ³ /h	A mm	B mm	C mm	D mm	Note	Weight kg
182337	F 3/4"	5,0	60	42	30	51	Mesh opening filter: 0.5 mm	0.3
182338	F 1"	10,0	71	46	36	61	Mesh opening filter: 0.5 mm	0.5
182339	F 1 1/4"	17,0	84	54	42	75	Mesh opening filter: 0.5 mm	0.9
182340	F 1 1/2"	19,0	93	61	47	88	Mesh opening filter: 0.5 mm	1.3
182341	F 2"	21,0	119	69	60	105	Mesh opening filter: 0.5 mm	2.1

LK 522 without handle - Male thread

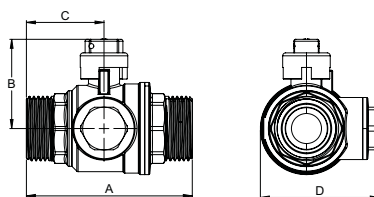

Article no.	Dim.	Kvs m ³ /h	A mm	B mm	C mm	D mm	Note	Weight kg
182434	M 3/4"	5,0	74	42	39	61	Mesh opening filter: 0.5 mm	0.4
182435	M 1"	10,0	85.5	46	45.5	61	Mesh opening filter: 0.5 mm	0.6

SPARE PARTS AND ACCESSORIES

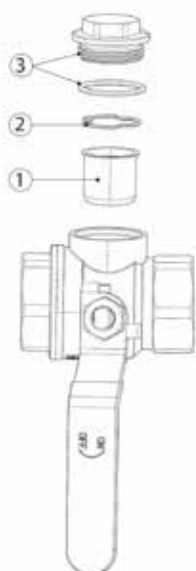

Article no.	Article	Position
095414	Filter ¾", Mesh opening: 0.7 mm	1
095415	Filter 1", Mesh opening: 0.7 mm	1
095416	Filter 1¼", Mesh opening: 0.7 mm	1
095417	Filter 1½", Mesh opening: 0.7 mm	1
095418	Filter 2", Mesh opening: 0.7 mm	1
095419	Filter ¾", Mesh opening: 0.5 mm	1
095420	Filter 1", Mesh opening: 0.5 mm	1
095421	Filter 1¼", Mesh opening: 0.5 mm	1
095422	Filter 1½", Mesh opening: 0.5 mm	1
095423	Filter 2", Mesh opening: 0.5 mm	1
095425	Locking ring / Clip ¾"	2
095426	Locking ring / Clip 1"	2
095428	Locking ring / Clip 1½"	2
095427	Locking ring / Clip 1¼"	2
095429	Locking ring / Clip 2"	2
095437	Cover & O-ring ¾"	3
095438	Cover & O-ring 1"	3
095439	Cover & O-ring 1¼"	3
095440	Cover & O-ring 1½"	3
095441	Cover & O-ring 2"	3

Filter Ball Valve with magnet

LK 522 FilterBall Magnet

- DZR Brass
- Easy to clean the filter
- Magnet Neodym, 12.000 gs



TECHNICAL DATA

Max. working pressure	1.6 MPa (16 bar)
Working temperature	Min. -20 °C/Max. 120 °C
Mesh opening, filter	0.7 mm / 0.5 mm
Thread standard	ISO 228/1
Media	Water - Glycol mixture max. 50%
Material, valve body	DZR Brass EN 12165 CW625N
Material, filter element	Stainless Steel
Material, sealing	PTFE
Material, cover sealing	EPDM
Material, magnet	Neodymium
Spindle sealing	Two O-rings, EPDM

LK 522 FilterBall Magnet is a filter ball valve with an integrated magnet for collecting magnetite, suitable for heating, cooling and tap water systems.

The filter and the magnet is easy to clean, just close the ball valve, unscrew the lid and remove the filter and the magnet.

The valve requires no maintenance, but the installation should still be checked regularly.

CAPACITY DIAGRAM - 0.7 MM

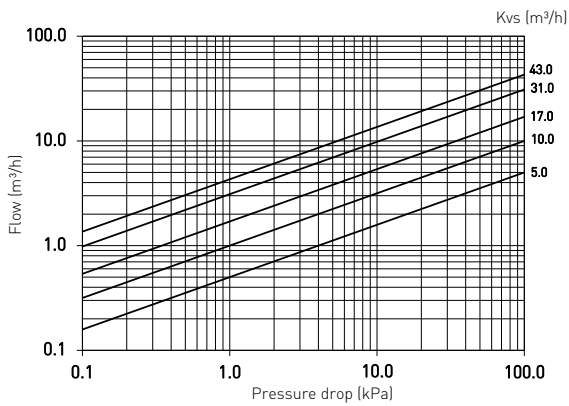

CAPACITY DIAGRAM - 0.5 MM

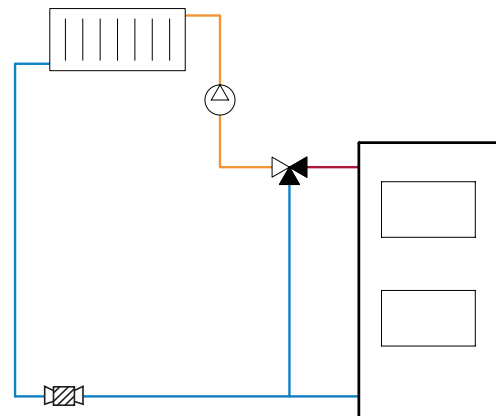
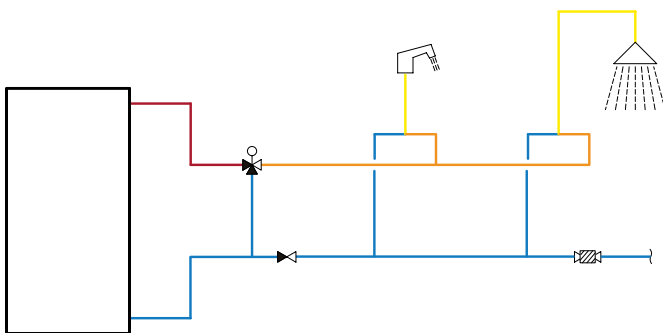
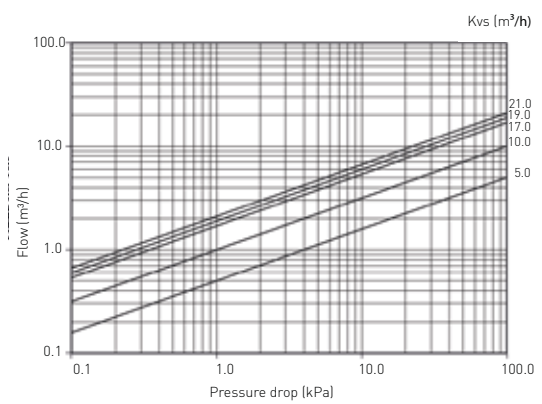

LK 522 Magnet - Female thread

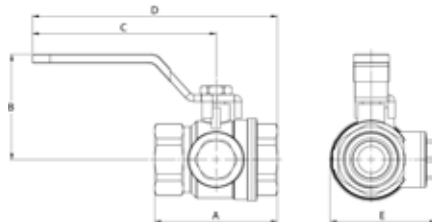

Article no.	Dim.	Kvs m ³ /h	A mm	B mm	C mm	D mm	E mm	Note	Weight kg
182274	F 3/4"	5,0	60	55	87	117	51	Mesh opening filter: 0.7 mm	0.3
182275	F 1"	10,0	71	60	107	142	61	Mesh opening filter: 0.7 mm	0.5
182276	F 1 1/4"	17,0	84	65	107	149	75	Mesh opening filter: 0.7 mm	0.9
182277	F 1 1/2"	31,0	93	80	143	189	88	Mesh opening filter: 0.7 mm	1.3
182278	F 2"	43,0	119	90	143	203	105	Mesh opening filter: 0.7 mm	2.1

LK 522 Magnet - Male thread

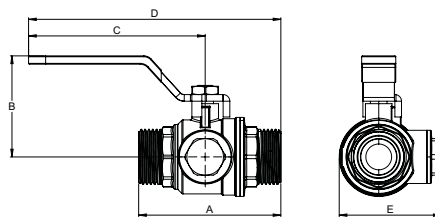

Article no.	Dim.	Kvs m ³ /h	A mm	B mm	C mm	D mm	E mm	Note	Weight kg
182436	M 3/4"	4,5	74	55	87	126	51	Mesh opening filter: 0.7 mm	0.4
182437	M 1"	9,0	85.5	60	107	153	61	Mesh opening filter: 0.7 mm	0.6

LK 522 Magnet, without handle - Female thread

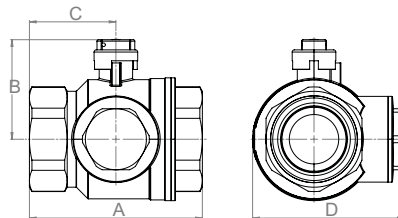

Article no.	Dim.	Kvs m ³ /h	A mm	B mm	C mm	D mm	Note	Weight kg
182342	F 3/4"	4,5	60	42	30	51	Mesh opening filter: 0.5 mm	0.3
182343	F 1"	9,0	71	46	36	61	Mesh opening filter: 0.5 mm	0.5
182344	F 1 1/4"	16,0	84	54	42	75	Mesh opening filter: 0.5 mm	0.9
182345	F 1 1/2"	19,0	93	61	47	88	Mesh opening filter: 0.5 mm	1.3
182346	F 2"	21,0	119	69	60	105	Mesh opening filter: 0.5 mm	2.1

LK 522 Magnet, without handle - Male thread

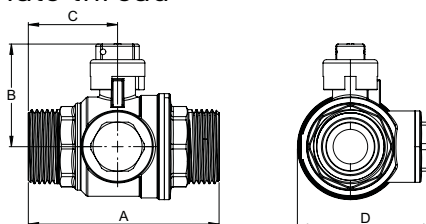

Article no.	Dim.	Kvs m ³ /h	A mm	B mm	C mm	D mm	Note	Weight kg
182438	M 3/4"	4,5	74	42	39	61	Mesh opening filter: 0.5 mm	0.4
182439	M 1"	9,0	85.5	46	45.5	61	Mesh opening filter: 0.5 mm	0.6

SPARE PARTS AND ACCESSORIES

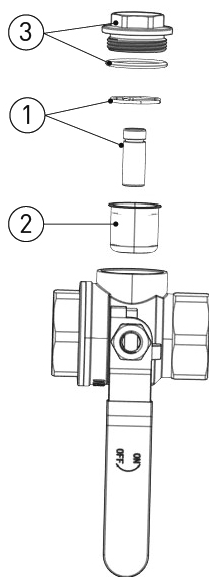

Article no.	Article	Position
095355	522 3/4" Magnet, Spring	1
095356	522 1" Magnet, Spring	1
095357	522 1 1/4" Magnet, Spring	1
095358	522 1 1/2" Magnet, Spring	1
095359	522 2" Magnet, Spring	1
095414	Filter 3/4", Mesh opening: 0.7 mm	2
095415	Filter 1", Mesh opening: 0.7 mm	2
095416	Filter 1 1/4", Mesh opening: 0.7 mm	2
095417	Filter 1 1/2", Mesh opening: 0.7 mm	2
095418	Filter 2", Mesh opening: 0.7 mm	2
095419	Filter 3/4", Mesh opening: 0.5 mm	2
095420	Filter 1", Mesh opening: 0.5 mm	2
095421	Filter 1 1/4", Mesh opening: 0.5 mm	2
095422	Filter 1 1/2", Mesh opening: 0.5 mm	2
095423	Filter 2", Mesh opening: 0.5 mm	2
095437	Cover & O-ring 3/4"	3
095438	Cover & O-ring 1"	3
095439	Cover & O-ring 1 1/4"	3
095440	Cover & O-ring 1 1/2"	3
095441	Cover & O-ring 2"	3

Safety Valve

LK 556 AntiFreeze

- Protects heating system from freeze damage
- The valve is maintenance-free
- Can be insulated to save energy



TECHNICAL DATA

Max. working pressure	0.6 MPa (6 bar)
Working temperature	0-75 °C
Opening temperature	3 °C
Ambient temperature	-30-60 °C
Storage temperature	-30-60 °C
Thread standard	G - male thread
Media	Water
Material, valve body	Brass EN 12165 CW617N
Material, sealing	EPDM

LK 556 AntiFreeze protects your heating system, usually in an air/water heat pump, if the fluid temperature should drop below +3°C by draining the system. This prevents the heating system from freezing.

If the valve opens and drains the system, no action is required to reset the valve, the system can be refilled again as soon as normal circulation in the heating system is resumed.

Insulation is available as an accessory for maximum energy saving. Refer to Accessories & Spare parts.

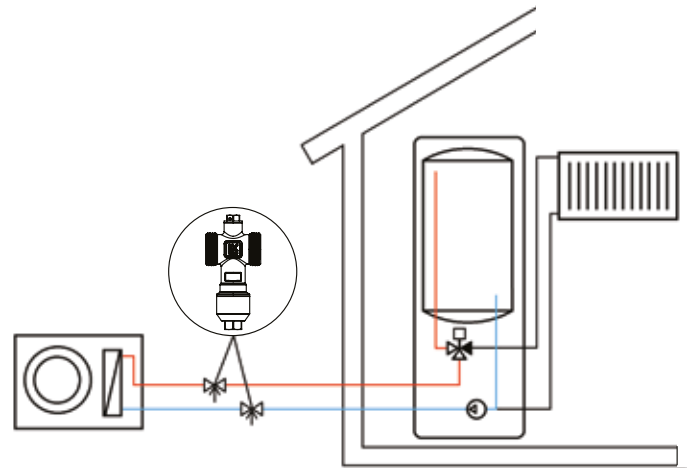

LK 556 - Male thread

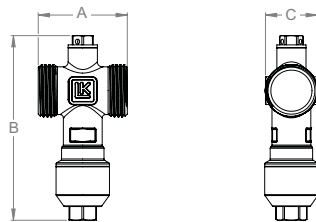

Article no.	Opening temp.	Dim.	DN	Kvs m ³ /h	A mm	B mm	C mm	Weight kg
182740	3 °C	M 1"	25	55	55	114	32	0.35
182741	3 °C	M 1¼"	32	70	55	123	42	0.4

SPARE PARTS AND ACCESSORIES

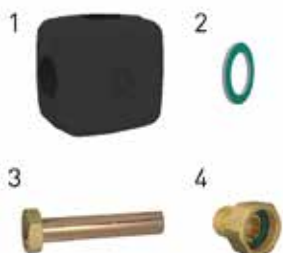

Article no.	Article	Position
187109	Insulation, DN 25-32	1
013010	Gasket Klingersil C4430 M32	2
013016	Gasket Klingersil C4430 M25	2
299189	Flanged pipe - 22 mm, F 1", L=120 mm	3
299190	Flanged pipe - 28 mm, F 1¼", L=120 mm	3
095380	Transition fitting M ¾" x F 1"	4
095381	Connection kit F 1" x M 1¼"	4

Air Vent Valves

LK 700/705 AeroMat

- Stainless steel



TECHNICAL DATA

Max. working pressure	1.6 MPa (16 bar)
Working temperature	Min. 5 °C/Max. 130 °C
Thread standard	G - male thread, G - female thread
Media	Water - Glycol mixture max. 50% Ethanol mixture max. 30%
Material, valve body	Stainless Steel EN 10088 1.4301
Material, sealing	PTFE
Material, ball valve	Brass EN 12165 CW617N, externally sandblasted and nickel-plated. Chrome ball

LK 700 and 705 AeroMat are automatic free floating air vent valves suitable for heating and cooling systems where pressure, temperature or media place high performance demands on the air vent valve.

The float vent valve is mounted vertically at a high point in the system. The shut-off valve is to be installed first and thereafter the float vent valve. The system should be flushed through and pressurized before mounting the float vent and opening the shut-off valve. Threads towards the system and the float vent are sealed in the usual manner.

The installation should be checked regularly. Sediments around the air outlet show that the float vent needs to be cleaned.

CHARACTERISTICS

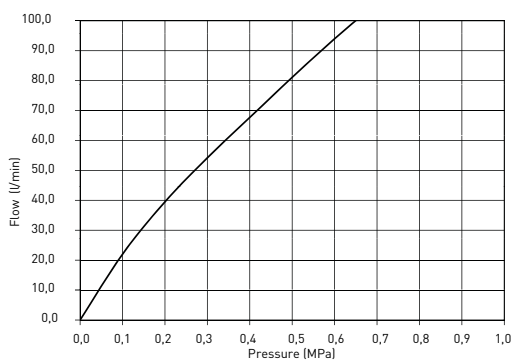

CLEANING THE FLOAT VENT VALVE

Close the shut-off valve and dismantle the float vent. Remove the black protective cap over the air outlet and unscrew the threaded union part underneath. Check that the outlet is free from impurities. If needed, clean with compressed air or cleaning needle. Clean the float vent by flushing it through with hot water from the top so that any impurities and sediments are removed. Reassemble the float vent valve in the reverse order.

LK 700 - Male thread

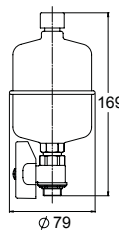

Article no.	Dim.	Note	Weight kg
094107	M 3/8"	without shut-off valve	0.4
4845228	M 3/8"	with shut-off valve	0.5

LK 705 - Female thread

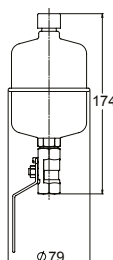

Article no.	Dim.	Note	Weight kg
4845244	F 3/8"	with shut-off valve	0.5

Safety Groups

LK 924 / 925 SafetyGroup

- Many connection options
- Several pressure classes possible
- Compact



TECHNICAL DATA

Max. working pressure	See the table below
Working temperature	Min 5 °C/Max 110 °C
Ambient temperature	Min 5 °C/Max 60 °C
Thread standard	Rp - female thread, G - male thread
Material, valve body	Brass EN 12165 CW617N

LK 924 / 925 SafetyGroup is a safety group for heating systems. The safety group contains manifold, manometer, safety valve and an air vent.

924 SafetyGroup has an automatic air vent with a float and 925 SafetyGroup has an automatic air vent with fibre discs. The manifold has two 1/2" connections for safety valve and for example an expansion vessel, one 3/8" connection for air vent.

The manometer shall be mounted in one of the three 1/4" connections, plug the other 1/4" connections with supplied plugs. Depending on model the manifold has a female 3/4" connection or a male 1" connection towards the heating system.

The manometer, air vent with a float and one 1/2" connection on the manifold are provided with a PTFE seal.

Safety valves in other pressure classes can be supplied upon request.

LK 924 - Female Thread

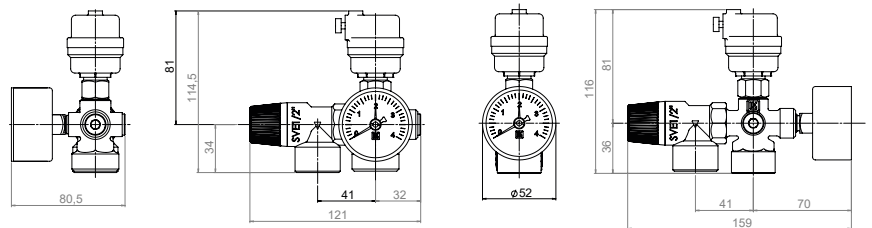

Article no.	Dim.	Opening pressure	Weight kg
092309	F 3/4"	0.3 MPa	0.6

LK 924 - Male thread

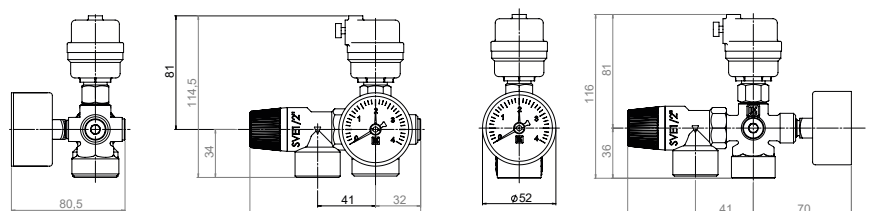

Article no.	Dim.	Opening pressure	Weight kg
092310	M 1"	0.3 MPa	0.6

LK 925 - Female thread

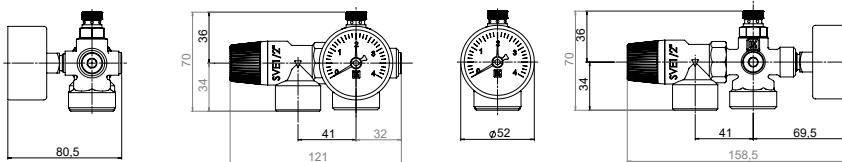

Article no.	Dim.	Opening pressure	Weight kg
092307	F 3/4"	0.3 MPa	0.5

LK 925 - Male thread

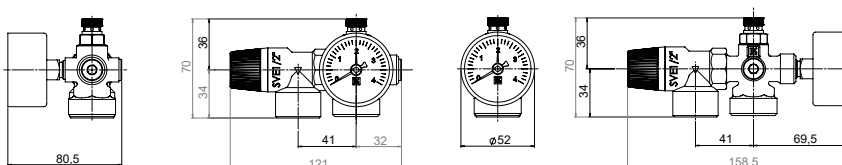

Article no.	Dim.	Opening pressure	Weight kg
092308	M 1"	0.3 MPa	0.5

SPARE PARTS AND ACCESSORIES

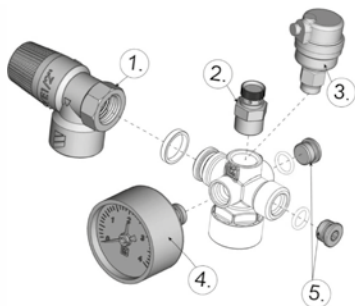

Article no.	Article	Position
095491	Safety relief valve 0.3 MPa	1
095492	750 G10 Ventilating valve	2
095497	740-G10 Floating air vent	3
095279	Manometer 50-4 bar M 1/4"	4
095493	Plug 1/4"	5

Safety Group

LK 994 SafetyGroup

- Adjustable bracket
- Automatic shutdown when removing expansion vessel



TECHNICAL DATA

Working temperature	5-110 °C
Ambient temperature	5-60° C
Thread standard	G - male thread
Media	Water - Glycol mixture max. 50%
Material, valve body	Brass EN 12165 CW617N

The LK 994 SafetyGroup is a safety group for heating systems.

Contains floating air bleed valve, drain valve, manometer, shut-off valve and wall bracket. During disassembly of the expansion vessel, the shut-off valve automatically closes against the heating system. The bracket is adjustable to fit different expansion tank sizes.

Assembly of the LK 994 is done by the installer to adapt to the specific application. The details are provided with Teflon or O-ring sealing for the easiest possible assembly. The safety group can be rotated 360° for maximum flexibility.

LK 994 - Male thread

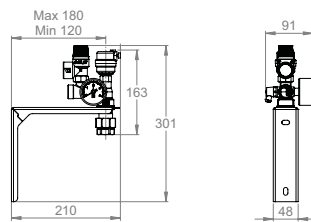

Article no.	Dim.	DN	Connection	Opening pressure	Discharge capacity	Weight kg
092371	M 3/4"	15	3/4"	0.3 MPa	89 kW	0.9

SPARE PARTS AND ACCESSORIES



Article no.	Article	Position
095279	Manometer 50-4 bar M 1/4"	1
095491	Safety relief valve 0.3 MPa	2
095497	740-G10 Floating air vent	3
095498	Drainage valve 1/4"	4

Fittings

LK MultiConnection



TECHNICAL DATA

Max. working pressure	1.6 MPa (16 bar)
Working temperature	Min -20 °C/Max 120 °C
Thread standard	Rp - female thread, G - male thread
Media	Water - Glycol mixture max. 50%
Material, valve body	DZR Brass EN 12165 CW625N

LK MultiConnections are a series of fittings for easy installation. Connections with fixed threads are designed for LK Armatur systems with O-ring seals (except 935).

Flat surfaces are sealed with fibre gaskets. See accessories for suitable fibre gaskets, below.

LK 931 - Male / Female / Rotating nut

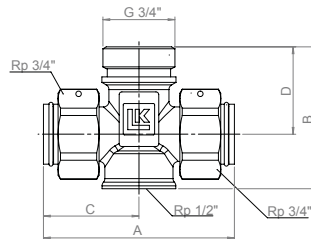

Article no.	Dim.	A mm	B mm	C mm	D mm	Weight kg
090090	M 3/4" x F 1/2" x F 3/4" rotating nuts x 2	70	52	35	32	0.2

LK 932 - Male / Rotating nut

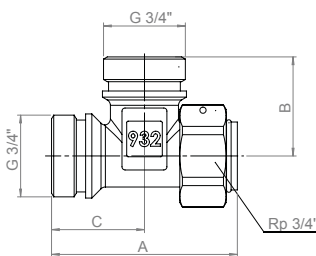

Article no.	Dim.	A mm	B mm	C mm	Weight kg
090091	M 3/4" x F 3/4" rotating nut	60	32	30	0.2

LK 933 - Male / Female / Rotating nut

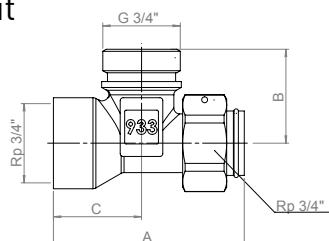

Article no.	Dim.	A mm	B mm	C mm	Weight kg
090092	M 3/4" x F 3/4" x F 3/4" rotating nut	65	32	30	0.2

LK 935 - Male / Rotating nut

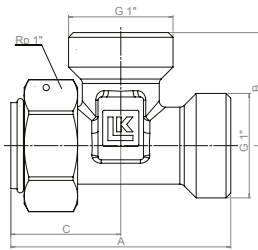

Article no.	Dim.	A mm	B mm	C mm	Weight kg
090257	M 1" x M 1" x F 1" rotating nut	70	36	35	0.2

LK 936 - Female / Male / Rotating nut

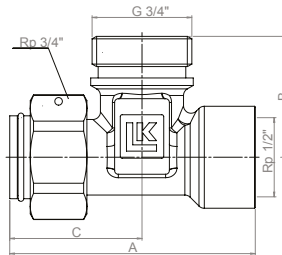

Article no.	Dim.	A mm	B mm	C mm	Weight kg
090258	F 1/2" x M 3/4" x F 3/4" rotating nut	65	32	35	0.2

SPARE PARTS AND ACCESSORIES



Article no.	Article	Position
013035	Gasket C4400 1"	1
013032	Gasket C4400 3/4"	2
012018	O-ring for M 3/4"	3

Transition Fittings

Transition Fittings



Transition fitting kits includes union, nut and gasket.

TECHNICAL DATA

Material, Union parts	Red brass, according to DIN 1705, ISO 1338
Material, Nuts	Brass
Material, Gaskets	Aramid fibre (type KLINGERSil C-4400)

Female thread / Rotating nut

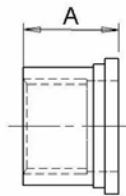
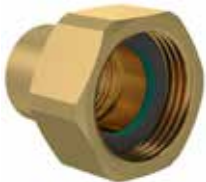

Article no.	Dim.	A mm	Weight kg
095364	F 3/8" x F 3/4"	21	0.07
095365	F 1/2" x F 1"	22	0.10
095366	F 3/4" x F 1 1/4"	22	0.15
095367	F 1" x F 1 1/2"	25	0.17
095368	F 1 1/4" x F 2"	29	0.35
095369	F 1 1/2" x F 2 1/4"	32	0.50

Male thread / Rotating nut

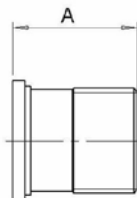

Article no.	Dim.	A mm	Weight kg
095379	M 1/2" x F 3/4"	27	0.08
095380	M 3/4" x F 1"	31	0.07
095381	M 1" x F 1 1/4"	35	0.01
095382	M 1 1/4" x F 1 1/2"	39	0.02
095383	M 1 1/2" x F 2"	41	0.02

Internal solder / Rotating nut



Article no.	Dim.	A mm	Weight kg
095371	15 mm x F 3/4"	19	0.02
095372	18 mm x F 3/4"	17	0.03
095373	18 mm x F 1"	19	0.04
095374	22 mm x F 1"	19	0.06
095375	28 mm x F 1 1/4"	25	0.08
095376	35 mm x F 1 1/2"	27	0.07
095377	42 mm x F 2"	31	0.02
095378	54 mm x F 2 1/2"	37	0.02

Internal solder / Male thread

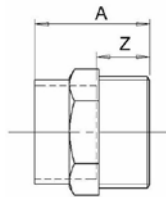

Article no.	Dim.	A mm	Z mm	Weight kg
2008134	15 mm x F 1/2"	25	14	0.03
2008217	18 mm x F 3/4"	26	13	0.06
2008241	22 mm x F 3/4"	29.5	15	0.05
2008258	22 mm x F 1"	30	15	0.06
2008282	28 mm x F 3/4"	41	22	0.1
2008290	28 mm x F 1"	36	17	0.1
2008332	35 mm x F 1 1/4"	43	20	0.1
2008381	42 mm x F 1 1/2"	48	21	0.2
2008423	54 mm x F 2"	58	26	0.3

Prefabricated pipes

Prefabricated pipes



Prefabricated pipes.

TECHNICAL DATA

Thread standard	Rp - female thread
Material 1	Stainless pipe
Material 2	Copper pipe

Flanged stainless pipe - for use between flat sealing connection to compression/pressfitting etc.



Article no.	Dim.	Dim. 2	Length	Weight kg
299103	Pipe 15 mm	Rotating nut F 20	L=120 mm	0.09
299104	Pipe 18 mm	Rotating nut F 20	L=120 mm	0.09
299105	Pipe 22 mm	Rotating nut F 25	L=120 mm	0.12
299106	Pipe 28 mm	Rotating nut F 32	L=120 mm	0.17
299107	Pipe 28 mm	Rotating nut F 40	L=120 mm	0.22

Flanged copper pipe - for use between flat sealing connection to compression/pressfitting etc.



Article no.	Dim.	Dim. 2	Length	Weight kg
299187	Pipe 15 mm	Rotating nut F 20	L=120 mm	0.09
299188	Pipe 18 mm	Rotating nut F 20	L=120 mm	0.09
299189	Pipe 22 mm	Rotating nut F 25	L=120 mm	0.12
299190	Pipe 28 mm	Rotating nut F 32	L=120 mm	0.17
299191	Pipe 28 mm	Rotating nut F 40	L=120 mm	0.22

Flanged copper pipe - for use between flat sealing connection



Article no.	Dim.	Dim. 2	Length	Weight kg
298972	Pipe 22 x 1	Rotating nut F 25	L=21 mm	0.1
298992	Pipe 18 x 1	Rotating nut F 20	L=20 mm	0.08
298993	Pipe 28 x 1.2	Rotating nut F 32	L=20 mm	0.14
S180810	Pipe 35 x 1.5	Rotating nut F 40	L=30 mm	0.16

SPARE PARTS AND ACCESSORIES



Article no.	Article	Position
013012	Gasket Klingersil C4430 M20	1
013016	Gasket Klingersil C4430 M25	1
013010	Gasket Klingersil C4430 M32	1
013015	Gasket Klingersil C4430 M40	1



We have been developing the HVAC industry for over 35 years, so why not let us develop a prefabricated solution to meet your needs?

With state-of-the-art machinery and significant engineering expertise, we process pipes, develop pipe systems and produce components for complete units, all to your specifications.

Our customised solutions are used, for instance, in applications for heating and tap water systems, hospital equipment and commercial dishwashers, etc. In our prefabrication department, we fabricate both pipes and assemble complete units.

All this means that we can offer you a wide range of benefits, such as fully customised solutions that optimise installation times, a large choice of materials, and deliveries “just-in-time”.



From concept to finished product

LK Armatur always assumes that there is a better way of doing things, and we have in-depth knowledge of our markets and their needs.

We are happy to use all this knowledge together with you to solve the challenges you face in terms of prefabricated products, among others.

So why not arrange a no-obligation meeting with a member of our sales team so we can take a look at your solutions to see if we can offer any suggestions for improvements?

Of course, our entire team of developers, sales staff and product specialists will accompany you throughout the project, from concept to finished solution.



PRODUCT EVALUATION

At one of our test laboratories in Helsingborg we can conduct validation tests on both constituent components and finished products in relation to long-term properties and performance tests.

APPLICATION KNOWLEDGE WITHIN:

- Heat pumps
- District heating
- Biofuels
- Solar heating
- Boilers

EXCELLENCE IN:

- Polymers
- Legislation & directives
- Mechanical engineering
- Electronics





Sustainability, for us, is more than a trend; it's a guiding principle.

In early 2023, we embarked on a transformative journey towards sustainability, recognizing the pressing need to address environmental, social, and economic challenges. We welcomed a dedicated sustainability specialist to our team, marking a pivotal step in our commitment.

Sustainability, for us, is more than a trend; it's a guiding principle. We are investing in internal training and workshops, setting clear sustainability goals aligned with global targets, and actively participating in global sustainability initiatives. Our approach is science-based, ensuring meaningful impact.

Beyond environmental concerns, we believe sustainability encompasses social and economic dimensions. As we work towards a greener future, we are proud to play our part in turning Europe green. Join us in building a more sustainable, equitable, and prosperous Europe and world. Together, we make a difference, one sustainable step at a time.

SBTi

At LK Armatur, we're proud to join forces with the Science Based Targets Initiative (SBTi), an organization at the forefront of driving ambitious climate action. This collaboration underscores our unyielding commitment to addressing climate change through science-based sustainability practices.

SBTi empowers organizations like ours to set emissions reduction targets firmly grounded in scientific principles, aligning with the global effort to combat climate change. Our partnership with SBTi goes beyond setting ambitious climate goals; it extends to active participation in global sustainability initiatives. Our actions are firmly rooted in scientific rigor, ensuring a substantial contribution to the global mission of combating climate change.

EPD

We are starting to work on our Environmental Product Declarations (EPD).

EPDs are more than just reports; they're a transparent, third-party-verified window into the environmental performance of products throughout their entire life cycle.

EPDs consist of two key components: an in-depth LCA report and a publicly accessible EPD document. This isn't just about setting environmental goals; it's about sharing verified data and taking real steps toward sustainability.

LCA (Life Cycle Assessments) is a comprehensive evaluation that encompasses every facet, from sourcing raw materials to envisioning end-of-life scenarios. These assessments align with internationally recognized standards, including EN 15804, adding a layer of credibility and transparency to the process.

The International EPD System ensures compliance with ISO standards and addresses the rising demand for building level Life Cycle Assessments, as seen in evolving regulations across Europe.

Why do EPDs matter?

- **Global Standards:** EPDs adhere to the EN 15804 standard, recognized internationally.
- **Comprehensive Assessment:** They cover the entire life cycle, not just parts of it.
- **Versatility:** EPDs work for goods and services of all kinds, regardless of company size.
- **Credibility:** Third-party verification ensures the data's reliability.
- **Transparency:** They follow an open framework, allowing everyone to understand the methodology.
- **Comparability:** EPDs allow fair product comparisons within the same category.

SBTi plays a pivotal role in defining and promoting best practices for emissions reductions and net-zero targets in line with climate science. By partnering with this initiative, we're making strides towards a more sustainable future for our company and the world. Together, we're committed to inspiring others to join us on this imperative journey.

This alliance is a testament to our belief that businesses have a vital role to play in curbing GHG emissions and building a resilient, zero-emissions economy. With SBTi as our ally, we're taking tangible steps towards a greener, brighter future for all.

The Global Goals

At LK Armatur, we are committed to the United Nations' Global Goals. These 17 goals serve as a global roadmap for a more sustainable, equitable, and prosperous future by 2030. Among these goals, we have identified five in which we actively make an impact today and intend to further focus on in the future.

- **Goal 6: Clean Water and Sanitation** - We work to ensure access to clean water and adequate sanitation, contributing to healthier communities and ecosystems.
- **Goal 7: Affordable and Clean Energy** - Our dedication to clean energy solutions promotes a sustainable, low-carbon future, reducing our environmental footprint.
- **Goal 8: Decent Work and Economic Growth** - We are committed to creating opportunities for decent work and inclusive economic growth within our operations.
- **Goal 9: Industry, Innovation, and Infrastructure** - Innovation and resilient infrastructure are integral to our efforts, driving economic development and progress.
- **Goal 12: Responsible Consumption and Production** - We are actively reducing waste, minimizing our environmental impact, and fostering sustainable consumption practices.





For the simpler, smarter everyday

LK

Simpler. Smarter. More sustainable. At LK, we believe there's a better way to do everything. That's why – from water, heating and hydronic solutions to pipe extrusion – we push for innovation over status quo and simplicity over complexity. It's a belief all of us at LK apply to every product and solution we create.

Our history

Founded in 1910, LK is a family business, working internationally in the heating, water and sanitation industry. A market leader in Sweden, the group currently employs approximately 400 people and actively increasing sales of products, systems and solutions in the Nordic region, Europe and the United States. LK works with continuous improvement and strives for a sustainable, long-term and respectful relationships with its employees, suppliers and customers.

Our companies

LK Armatur is a leader in Europe, producing millions of valves per year for the global HVAC market. Beyond individual products, we understand how all parts interact in your complete application. From standard to sophisticated customizations of valves, controllers, components and prefabricated units, our full-spectrum expertise makes it easy to get the results you need today, while anticipating your needs tomorrow.

LK Pex is a leading OEM manufacturer of high-quality plastic pipes for the HVAC industry, particularly housing applications. Our proprietary production technology for cross-linking PE-Xa tubes gives pipes unique flexibility and compressive strength. With this and every advancement we make, we aim to simplify your everyday challenges for smarter results today and tomorrow.

LK Systems is the leading manufacturer of easy-to-install systems for heating and tap water distribution in the Nordics. Through our prefabrication unit, we also provide tailor-made solutions that simplify the installation process even further.

For more information about the LK group, visit www.lk.nu

LK Armatur

- A One-Stop Supplier

LK Armatur was founded in 1985 when the LK Group increased its focus on supplying manufacturers of heaters and hot water heaters with valves and components.

We are a complete supplier of customised products and solutions and we produce millions of valves annually. We have advanced pipe manipulation & bending facilities for both stainless steel and copper pipes and our accessories come from leading suppliers in Europe. Our extensive product range consists of 4 product areas:

- Valves
- Electronic Heat Regulation
- Prefabrication
- Accessories



Our aim is to provide high quality, technically advanced products that are easy to install and uncomplicated to use. We constantly develop and design new products and the demands are high to meet our customers' as well as our own high expectations.

We focus on customers who see energy saving and environmental awareness as a matter of course. The risk of energy shortage, the steady increase in energy prices and the problem of global warming have created a great need for cost and energy

Helsingborg, Sweden; Our Main Office. We develop and manufacture most of our products here.

Bad Oeynhausen, Germany; Main Office for Germany sales company, LK Armatur Deutschland GmbH.

Zrenjanin, Serbia; Production unit focusing on pipe prefabrication.

efficient heating systems in which renewable energy sources can be utilized. The common denominator for our customers is their stringent requirements for quality, customization and delivery reliability.

Our management system complies with ISO 9001:2008 and ISO 14001:2004 for the development, manufacture and distribution of valves, electronic heating controls and prefabricated systems.



Table of Contents

LK ARMATUR - Information	3	ZONE VALVES	103
New products	4	Design your own valve	104
Table of Contents	6	Quick-coupling solutions	106
LOADING UNITS	9	LK 525 MultiZone 2W.....	107
LK 810 ThermoMat 2.0	10	LK 525 MultiZone 3R.....	110
LK 811 ThermoMat 2.0.....	14	LK 525 MultiZone 3W.....	112
LK 815 ThermoKit T Eco.....	16	LK 527 MultiZone 2W.....	116
LK 816 ThermoKit E Eco.....	18	LK 527 MultiZone 3W.....	118
PUMPGROUPS	21	Exhibitions.....	120
LK HydronicGroup 90C.....	24	FILLING VALVES	121
LK HydronicGroup C/C 90.....	25	LK 321 MultiFill®	122
LK HydronicGroup C/C 125.....	28	LK 521 MultiFill®	123
TAP WATER UNITS	37	LK 538 ThermoFill EA.....	125
LK 250 TapWaterUnit	38	LK 539 ThermoFill EA.....	127
SOLAR STATIONS	41	VALVES FOR WATER HEATING	129
LK 211 SolarStation (single)	42	LK 510/511/512 MultiSafe.....	130
LK 212 SolarStation	45	LK 514 MultiSafe.....	132
Social Media.....	48	LK 322 CoolUnit	133
THERMIC VALVES AND CHECK VALVES	49	LK 548 AquaKit	134
LK 820 ThermoVar®	50	LK 550 AquaMix	136
LK 821 ThermoVar®	53	LK 551 HydroMix	138
LK 822 ThermoBac	55	LK 551 F HydroMix	141
LK 823 ThermoVar®	57	LK 551 HydroKit Solar.....	143
LK 823 ThermoVar® R.....	59	LK 551 HydroKit HWC	145
MIXING VALVES	61	LK 551 HWC CirculationKit	147
LK 525 MultiZone 3R.....	62	LK 552 HydroMix	148
LK 830 ThermoMix®	64	PRODUCTS FOR UNDERFLOOR HEATING	151
LK 831 ThermoMix® B	67	LK 419 Manifold Shunt.....	152
LK 840 ThermoMix®2.0.....	69	LK 420 MiniShunt 2.0.....	153
LK 840 ThermoMix® C	73	LK 421 Manifold Shunt.....	155
LK 841 ThermoMix®2.0.....	75	LK 422 Manifold Shunt Tmax.....	157
LK 842 ThermoMix® P	78	LK 423 MiniLoop RTC.....	159
LK 843 ThermoMix®.....	80	LK 430 Manifold.....	161
LK 850 ThermoMix® H.....	82	LK 435 OptiFlow.....	163
LK 851 ThermoMix® H.....	84	LK 440 EasyHeat	165
TEMPERATURE CONTROLLERS AND VALVE ACTUATORS	87	LK 450 EasyHeat P.....	166
LK SmartComfort	88	LK 450 EasyHeat M.....	168
LK 941 EasyMix	92	OTHER PRODUCTS	171
LK 950 Valve Actuator	93	LK 315 BallValve	172
MOUNTING KITS	94	LK 360 NetMag.....	173
DIFFERENTIAL TEMPERATURE CONTROLLERS	95	LK 519 ThermoSafe	174
LK 150 SmartSol.....	96	LK 522 FilterBall	175
LK 160 SmartBio®.....	98	LK 522 FilterBall Magnet	178
LK 162 SmartStove	101	LK 556 AntiFreeze	181
		LK 700/705 AeroMat	182
		LK 924/925 SafetyGroup	183
		LK 994 SafetyGroup	185
		LK MultiConnection	186
		Transition Fittings.....	188
		Prefabricated pipes.....	190
		Sustainability	194
		LK GROUP	196
		LK ARMATUR	197

LK ARMATUR AB

Garnisonsgatan 49
SE-254 66 Helsingborg
Sweden

Phone: +46 (0)42-16 92 00
info@lkarmatur.se
order@lkarmatur.se

FOR THE SIMPLER, SMARTER EVERYDAY

Simpler. Smarter. More sustainable. At LK, we believe there's a better way to do everything. It's a belief all of us at LK apply to every product and solution we create – from water, heating and hydronic solutions to pipe extrusion.

LK Armatur is a leader in Europe, producing millions of valves per year for the global HVAC market. Beyond individual products, we understand how all parts interact in your complete application. From standard to sophisticated customizations of valves, controllers, components and prefabricated units, our full-spectrum expertise makes it easy to get the results you need today, while anticipating your needs tomorrow.

